

International
Chemical Series

8691
A80(2)

TP161
P25

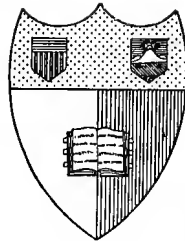

Cornell University Library
Ithaca, New York

BOUGHT WITH THE INCOME OF THE
SAGE ENDOWMENT FUND

THE GIFT OF
HENRY W. SAGE

1891

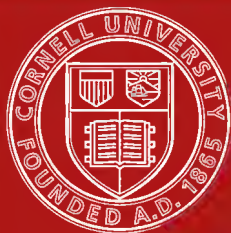

Cornell University Library

The original of this book is in
the Cornell University Library.

There are no known copyright restrictions in
the United States on the use of the text.

<http://www.archive.org/details/cu31924004695387>

INTERNATIONAL CHEMICAL SERIES

H. P. TALBOT, PH.D., Sc.D., CONSULTING EDITOR

THE ANALYSIS
OF
FUEL, GAS, WATER AND LUBRICANTS

INTERNATIONAL CHEMICAL SERIES

(H. P. TALBOT, PH.D., SC.D., CONSULTING EDITOR)

- Bancroft*—
APPLIED COLLOID CHEMISTRY
- Bingham*—
FLUIDITY AND PLASTICITY
- Cady*—
INORGANIC CHEMISTRY
- Cady*—
GENERAL CHEMISTRY
- Griffin*—
TECHNICAL METHODS OF ANALYSIS
As Employed in the Laboratories of Arthur D. Little, Inc.
- Hall and Williams*—
CHEMICAL AND METALLOGRAPHIC EXAMINATION OF IRON, STEEL AND BRASS
- Hamilton and Simpson*—
CALCULATIONS OF QUANTITATIVE CHEMICAL ANALYSIS
- Loeb*—
PROTEINS AND THE THEORY OF COLLOIDAL BEHAVIOR
- Lord and Demorest*—
METALLURGICAL ANALYSIS
Fourth Edition
- Mahin*—
QUANTITATIVE ANALYSIS
Second Edition
- Mahin and Carr*—
QUANTITATIVE AGRICULTURAL ANALYSIS
- Millard*—
PHYSICAL CHEMISTRY FOR COLLEGES
- Moore*—
HISTORY OF CHEMISTRY
- Norris*—
TEXTBOOK OF INORGANIC CHEMISTRY FOR COLLEGES
- Norris and Mark*—
LABORATORY EXERCISES IN INORGANIC CHEMISTRY
- Norris*—
ORGANIC CHEMISTRY
Second Edition
- Norris*—
EXPERIMENTAL ORGANIC CHEMISTRY
- Parr*—
ANALYSIS OF FUEL, GAS, WATER AND LUBRICANTS
Third Edition
- Robinson*—
THE ELEMENTS OF FRACTIONAL DISTILLATION
- White*—
TECHNICAL GAS AND FUEL ANALYSIS
Second Edition
- Williams*—
PRINCIPLES OF METALLOGRAPHY
- Woodman*—
FOOD ANALYSIS

THE ANALYSIS
OF
FUEL, GAS, WATER AND LUBRICANTS

BY

S. W. PARR

PROFESSOR OF APPLIED CHEMISTRY, UNIVERSITY OF ILLINOIS

THIRD EDITION
THIRD IMPRESSION

McGRAW-HILL BOOK COMPANY, INC.
NEW YORK: 370 SEVENTH AVENUE
LONDON: 6 & 8 BOUVERIE ST., E. C. 4

1922

Fa

8691
A 80(2)

A 532701

COPYRIGHT, 1922, BY THE
MCGRAW-HILL BOOK COMPANY, INC.

—————
COPYRIGHT, 1911, 1916, BY S. W. PARR

—————
PRINTED IN THE UNITED STATES OF AMERICA

PREFACE TO THIRD EDITION

The present edition has been expanded somewhat to admit of its being used as a text by students in Chemistry and Chemical Engineering in their Junior year. It is believed that the added material will still leave the work well adapted to the chemical status of students in Mechanical Engineering. For such students it is well to begin with the topic of Boiler Waters, since this serves as an excellent medium for reviving their elementary chemistry. For such students it will be found desirable also to devote two or three periods to a review of such topics as nomenclature, especially that relating to acids, bases and salts, also valence, reactions, solubilities, and a simplified arrangement of the periodic table which will set forth these properties for about 16 or 18 of the more common elements. This will include practically all of the chemical considerations likely to be met with in the study of boiler waters. It will have the further advantage of connecting many chemical facts with a topic of immediate interest to the engineer, and in such a manner as incidentally to advance him materially in the matter of his chemical information.

The author is under special obligation to Floyd B. Hobart for his very efficient help in preparing the manuscript for the printer. He wishes also to express his appreciation for helpful suggestions and careful reading of the text by Dr. T. E. Layng and Dr. M. J. Bradley, also to Dr. R. E. Greenfield for reviewing the text on Boiler Waters and to J. M. Lindgren for helpful suggestions on methods for fuels and oils.

Criticisms and suggestions from users will be especially welcome.

S. W. PARR.

UNIVERSITY OF ILLINOIS,
URBANA, ILLINOIS,
October, 1921.

PREFACE TO FIRST AND SECOND EDITIONS

This work is intended primarily for Juniors in Mechanical and Railway Mechanical Engineering at the University of Illinois. From the chemical standpoint, it is a very serious problem to know what may profitably be attempted in the way of analytical methods in the case of students whose chemical experience is meager. But, however unsatisfactory the amount of preliminary training, it is obvious that the curriculum in Engineering courses is already overcrowded, hence the obtaining of a better prerequisite in chemistry is well nigh impossible. The work as herein outlined is the result of ten years of effort to make the most of the situation. It would be quite too much to claim that in the evolution of the work a satisfactory status has been attained. It is hoped, however, that the course will at least help the engineer to a better understanding of the literature of the topics considered and also to an appreciation and, consequently, a more intelligent use of data which may come into his hands from the chemist. It may not be out of place to state further that the course, which, at the first, was inaugurated with no little misgiving, has more than justified the experiment. For this result credit is due the students, who, from year to year have carried the work through with a responsiveness which has been the main stimulus in developing this outline into its present form.

Part I is a synopsis only of the lectures given. Part II consists essentially of laboratory directions for the analytical methods there undertaken. The time allowance for lectures, quizzes, and laboratory is nine hours per week for 18 weeks. The amount of work as outlined is such that the average student covers the ground in the time prescribed.

Special acknowledgment is due Dr. H. J. Broderson for suggested improvements in the present edition and for valued assistance in the reading of proof.

CONTENTS

	PAGE
PREFACE TO THIRD EDITION	v
PREFACE TO FIRST AND SECOND EDITIONS	vii
PART I	
LECTURES	
CHAPTER I	
FUELS.	1
Introduction—Fuel types—Coal—Coke—Wood—Petroleum— Distillates—Alcohol—Gases.	
CHAPTER II	
COAL	5
Introduction—Output—Distribution of reserve supplies—Relative output of principal producing states—Distribution of types.	
CHAPTER III	
SAMPLING OF COAL.	11
Introduction—Necessity of care—Material to be taken—Amount— —Ratio of size to mass—Mixing and subdividing—Riffling —Sampling a carload—Composite samples—Mechanical sampling —Moisture control—Dust determinations—Laboratory sample.	
CHAPTER IV	
ANALYSIS OF COAL	25
Moisture and nomenclature—Calculations—Methods of analysis— General plan—Interpretation of moisture values—Ash—Sulphur— Volatile matter—Fixed carbon.	
CHAPTER V	
UNIT COAL	31
Definitions—Derivation of the formula for unit coal—Correction constant for water of composition—Accuracy of constants em- ployed for correction of ash.	

	PAGE
CHAPTER VI	
CALORIMETRIC MEASUREMENTS.	36
Definitions—Heat values by calculation—The Berthier test—Lewis Thompson calorimeter—Other types—Oxygen bomb calorimeter—Correction for radiation—Adiabatic insulation—Correction for acids—Correction for fuse wire—The peroxide calorimeter—Gross and net heat values.	
CHAPTER VII	
ULTIMATE ANALYSIS	49
Total carbon—Derivation of hydrogen by calculation.	
CHAPTER VIII	
CLASSIFICATION OF COALS.	51
Frazer's classification—Fuel ratio—Carbon-hydrogen ratio—Carbon ratio—Classification by heat values—Derivation of heat values for unit coal—Composition of Illinois coals.	
CHAPTER IX	
COAL CONTRACTS.	59
Introduction—Calculation of commercial heat values for contracting purposes—Significance of heat values—Concerning the ash—Bids and awards—Price and payment—The formulation of proposals.	
CHAPTER X	
THE COMBUSTION OF COAL	65
General principles—Oxygen supply—Smoke—Clinker formation—Fusibility of ash—The wetting of coal.	
CHAPTER XI	
STORAGE, WEATHERING AND SPONTANEOUS COMBUSTION	73
Deterioration—Spontaneous combustion—Storage methods.	
CHAPTER XII	
COKE.	80
General statement—Metallurgical coke—Sampling and analysis—Pulverizing of coke—Volatile matter—Sulphur.	
CHAPTER XIII	
WOOD.	83
Introduction—Heat values.	
CHAPTER XIV	
PETROLEUM, DISTILLATES AND ALCOHOL	85
Use—Output—Heat values—Distillates—Alcohol.	

CHAPTER XV

FUEL GAS.	89
Types—Heating value of gas—Flow calorimeters—High and low heat values for combustible gases—Ammonia and Sulphur—Apparatus for the analysis of fuel gases—Analysis of fuel gas—Computation of volume of paraffins from analytical data—Heat values by calculation.	

CHAPTER XVI

FLUE GASES.	104
Gas volumes—Sampling and analysis—Calculation of efficiencies and heat losses—Other losses.	

CHAPTER XVII

BOILER WATERS, THEIR EXAMINATION, CHARACTER AND TREATMENT .	112
Water analysis—Source of mineral constituents—Chemical characteristics of the mineral constituents—Solubility of Gypsum—Effects of Impurities—Scaling Ingredients—Effect of scale—Foaming ingredients—Corrosive ingredients—Classification—The chemical treatment of boiler waters—Treatment with lime—Treatment with soda ash—Treatment with coagulants—Industrial methods—Summary of ratios—Standards for indicating degrees of hardness—Limits of purification—Typical waters and their treatment—Zeolites.	

CHAPTER XVIII

LUBRICANTS	137
Introduction—Animal and vegetable oils—Mineral oils—Compounded oils—Testing.	

PART II

LABORATORY METHODS

CHAPTER XIX

THE PROXIMATE ANALYSIS OF COAL	141
Introduction—The laboratory sample—Moisture loss on air drying—Working sample—Moisture in the laboratory sample—Total moisture—Ash—Volatile matter, official method—Volatile matter, porcelain crucible method—Fixed carbon—Calculations.	

CHAPTER XX

CALORIMETRY, USING SODIUM PEROXIDE	149
General statement—The fuel sample—The chemical: sodium peroxide—The accelerator: potassium chlorate—Making up the charge—Ignition—Temperature readings—Calculations—To dismantle—Anthracites and coke—For petroleum oils—Gasoline, etc.—Standardization.	

	PAGE
CHAPTER XXI	
CALORIMETRY, USING THE OXYGEN BOMB.	161
General statement—Heat values by oxygen bomb calorimeter—	
Corrections—Standardization—Adiabatic Conditions.	
CHAPTER XXII	
SULPHUR DETERMINATIONS	171
General Statement—Total Sulphur.	
CHAPTER XXIII	
ULTIMATE ANALYSIS	179
Total carbon determination—Hydrogen—Oxygen.	
CHAPTER XXIV	
FUEL GASES ANALYSIS	185
Introduction—Description of apparatus—Manipulation and	
description of reagents—Determination of sulphur in gas—Direct	
determination of heating value—Operation at the Junker calori-	
meter.	
CHAPTER XXV	
THE ANALYSIS OF FLUE GASES	201
Reagents—The analysis of atmospheric air—The analysis of	
respired air—Flue gas.	
CHAPTER XXVI	
ANALYSIS OF BOILER WATERS.	204
Normal solutions—Standard sodium carbonate—Standard sulfuric	
acid—Determination of sulphur—Standard calcium chloride and	
soap solutions—Standardization of the soap solution—Determi-	
nation of calcium sulphate in water—Excess of free carbon dioxide—	
Total alkalinity and temporary hardness—Magnesia—Permanent	
hardness—Negative hardness—Total hardness—Determination of	
total sulphates—Determination of total chlorides—Total alkalies	
—Examination of a treated water—Summary of results and calcu-	
lations.	
CHAPTER XXVII	
OIL EXAMINATION	221
Specific gravity—Flash and fire test—Viscosity—Free acid—	
Saponification number—Maumené test—The Conradson test	
—Emulsification.	
APPENDIX.	230
INDEX	245

THE ANALYSIS OF FUEL, GAS, WATER AND LUBRICANTS

PART I LECTURES

CHAPTER I

FUELS

Introduction.—Motion, industrially considered, is a commodity which, when available in proper form and in sufficient quantity, is designated as power.

The sources of motion are two in number :

1. Gravity.
2. Chemical action.

Gravity is transformed into motion through the medium of falling water, and to a smaller extent by means of wind currents.

Chemical activity may be derived from the world's fuel supply in greater amount and at less cost than from any other source.

By the burning of fuel, chemical action may be made to transfer its motion through the medium of steam or, to a smaller extent, as in the internal combustion engine, directly and without any medium, to the working parts of machinery. Proximity to fuel beds, therefore, or accessibility by reason of shipping facilities is an index of present or potential activity along industrial lines. Hence, it is evident that the fundamental purpose of the industrial examination of fuels is to measure correctly the amount of chemically active material which resides in a given sample. This may be determined in two ways: First, by analytical methods wherein the amount of inorganic or chemically inactive

substance is determined, as distinct from the organic or chemically active material; and, second, by actual combustion whereby the fuel is made to indicate its activity by the evolution of heat, the quantity of which may be measured.

Fuel Types.—For convenience in discussion, fuels are divided into solid, liquid, and gaseous types. This classification with further subdivisions may be shown in tabulated form as follows:

FUELS	Solid	{	Coal
		{	Coke and Charcoal
		{	Wood
	Liquid	{	Petroleum
		{	Distillates
		{	Alcohol
	Gaseous	{	Natural Gas
		{	House Gas
		{	Producer Gas

Coal.—Coal is by far the most abundant and cheapest of all fuels. It varies in character from the hard, rock-like anthracites to the soft lignites. The inert non-active substances in the form of water and ash vary from 8 to 40 per cent, and are inversely related to the quantity of heat available. Since these factors are fundamental in the commercial estimation of values, classification, etc., they will be discussed under the more general treatment of coal which is taken up later.

Coke.—Coke is at present chiefly a fuel having special properties which make it suitable for metallurgical purposes. It has very little inactive material except the ash, which is always of higher percentage than in the coal from which it is made. Measured in terms of heat units, coke is approximately equal to the average anthracite coal.

Wood.—By reason of the high cost of wood, it is rapidly passing out of the list of available fuels. While its content of inactive substance in the form of ash is low, its content of free moisture is high even in seasoned wood, and together with combined water constitutes more than half of the wood by weight. Its activity, therefore, measured as heat is only about half that of good coal averaging 6,500 or 7,000 B.t.u. per pound of wood. Since a cord of well seasoned oak or maple weighs approximately 4,000 lb., that amount is equal in heat value to 1 ton of coal.

Pine wood is approximately $\frac{1}{2}$ as heavy with a slightly higher thermal value per pound.

Petroleum.—Chemically considered, petroleum is a complex mixture of hydrocarbons in which those of the heavier type, having a lower ratio of hydrogen to carbon, predominate. The heat values range from 18,000 to 20,000 B.t.u. per pound. Crude petroleum varies in character, some districts yielding heavier and some lighter oils. Petroleum residues have had the lighter oils removed by distillation. These residues are of higher specific gravity and lower heat value.

Distillates.—The distillates are hydrocarbon compounds mainly derived from petroleum, and are almost entirely free from inactive material. Their heat value varies with the specific gravity, which directly is a measure of the ratio of carbon to hydrogen. The lighter the distillate the higher the ratio of hydrogen and, consequently, the higher the heat value, which may vary from 19,000 to 22,000 B.t.u. per pound.

Alcohol.—Alcohol is a prospective rather than a present source of fuel energy. It involves the fermentation of starch as obtained from grain, potatoes, etc. or of sugars, as in by-product molasses from sugar factories, or of wood waste after hydrolyzing the cellulose. Interesting possibilities also of synthetic alcohol from acetylene and ethylene have recently been developed.

Alcohol has no ash but a large percentage (34.8 per cent) of combined oxygen, which approximately represents the inert material. Its heat value in pure form is 12,391 B.t.u. per pound.

One important feature connected with alcohol is the fact that while other sources of volatile fuels present a limited or diminishing supply, the possible expansion of material for the production of alcohol is unlimited.

Gases.—Gases are more or less mixed with inert material and, when measured with reference to their chemical activity in the form of heat, the values are referred to a cubic foot at 60°F. temperature and a pressure of 30 in. of mercury, as representing the average or standard temperature and pressure of the atmosphere. Because of the inevitable tendency for all forms of this material to have an admixture of inert gases, the heat values are very variable. Their character may, however, be expressed in a general way as follows:

Natural gas is usually composed in large part of methane or marsh gas, which in pure form has a value of 1,010 B.t.u. per cubic foot at the above temperature and pressure.

House gas in the majority of cities in the United States is required to have a heat value of approximately 600 B.t.u. per cubic foot. This standard, however, is being lowered in many localities.

Producer gas may vary from 150 to 225 units in the richer form to 125 units in the "suction" gas producer, and to as low as 90 units per cubic foot in the gases from the blast furnace, which may be looked upon as a special type of gas producer.

CHAPTER II

COAL

Introduction.—Of all the fuel supplies available, coal constitutes by far the largest part. Our chief consideration, therefore, will be given to this topic. A glance at the map, Fig. 1, will give a general idea of the distribution of coal in the United States. These coal areas together with transportation facilities are the chief factors in the development of industrial

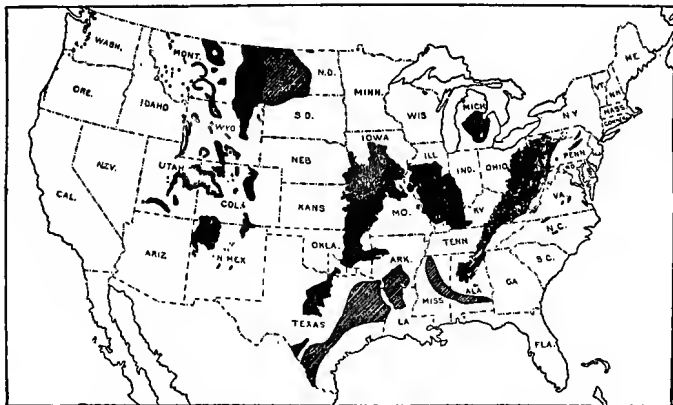

Fig. 1.—Distribution of coal fields in the United States.

centers. From the economic standpoint we will be interested in the output as a whole and also the relative yields from the main producing areas. The types also and their distribution are of chemical as well as industrial importance and are given brief reference.

Output.—The annual output of coal, including lignites, in the United States for 1920 was approximately 676,000,000 short tons. A chart, Fig. 2, of the production by years is of interest since it serves as an index of industrial activity. It presents also a suggestion in graphic form of the possibility of ultimate

exhaustion of this source of fuel supply, and the necessity of developing the highest possible efficiencies in its use. Inci-

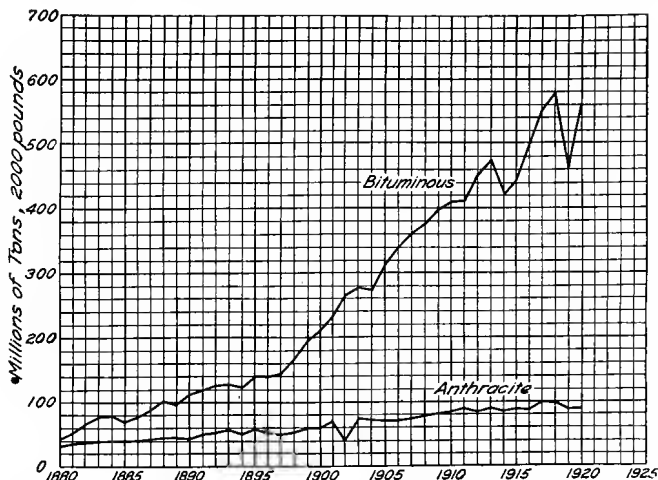

FIG. 2.—Annual output of coal in the United States, 1880 to 1920.

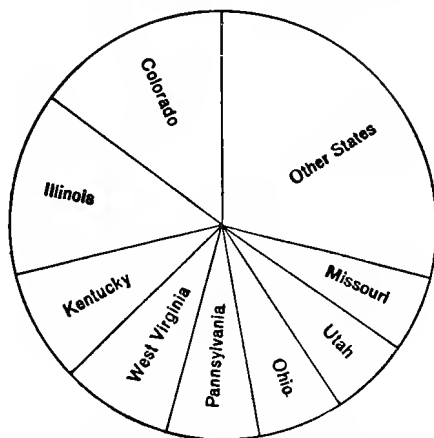

FIG. 3.—Coal reserves, showing the relative available coal resources of the United States.¹

dentally, it may be noted that the world output of coal for 1920 was estimated at 1,430,000,000 short tons, from which it will be

¹ Ill. State Geol. Surv. Yearbook for 1916, p. 26.

seen that the yield for the United States was 45 per cent of the total.

Distribution of Reserve Supplies.—A chart of the coal resources by states is shown in Fig. 3. The estimated tonnage in reserve for the five states having the most extensive coal deposits

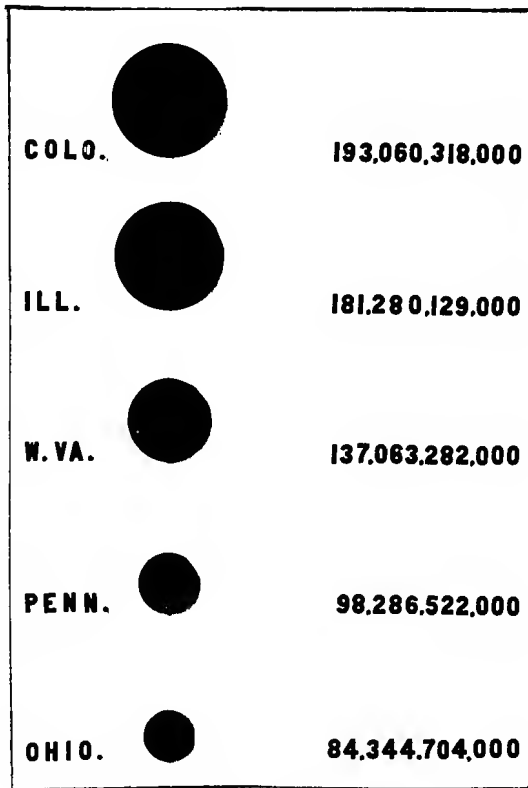

FIG. 4.—Available bituminous coal, short tons.¹

is shown by comparative areas in Fig. 4. From this chart it will be seen that Colorado has the greatest amount. Very considerable areas, however, are at so great a depth that the winning of all the coal reserve of that state is somewhat problematical. Large deposits also are of the subbituminous or lignitic type,

¹ Ill. State Geol. Survey.

hence supremacy in the matter of fuel values is not likely to migrate westward.

Relative Output of Principal Producing States.—The relative production of bituminous coal for the four principal producing states is shown in Fig. 5. While the coal resources of Illinois exceed those of either Pennsylvania or West Virginia, the annual production for these states is not in relative proportion to the estimated reserves. The explanation would doubtless be found mainly in the matter of chemical composition and special characteristics. For example, by far the greater part of the

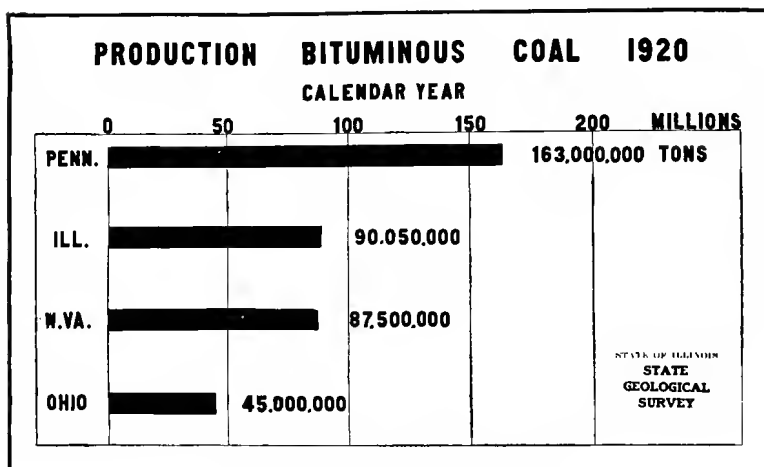

FIG. 5.—Bituminous coal output.

coking coals are mined in Pennsylvania. In 1920 the estimated amount of coal devoted to coke making was 77,000,000 tons. If the coals of Illinois were able to produce a metallurgical coke and Pennsylvania coals were not so constituted, other factors remaining the same it would doubtless result in an interchange of data, that is, Illinois would be credited with an output of 163,000,000 tons and Pennsylvania with 90,000,000 tons. These figures would then more nearly conform to the relative reserves for each state. This reference alone, among numerous others which might be given, may serve as an illustration of the desirability on the part of the chemist of familiarizing himself with the

composition, characteristics and types of the coals in the various regions of the country. Greater efficiency in the use of a low-grade coal may even give it an advantage over the coal of higher grade. Coking conditions may also be modified so that the chemical studies connected with our coal supplies may involve a wide range of interests from the purely scientific phase to the relations which are mainly industrial or economic.

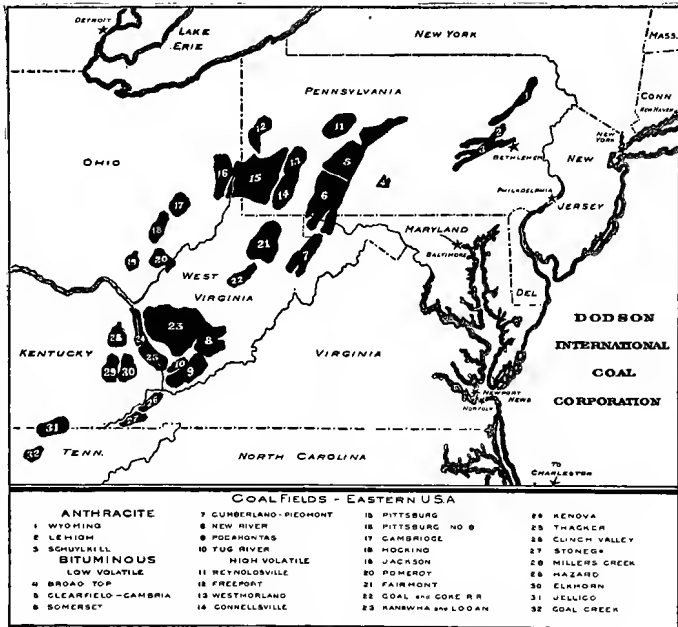

FIG. 6.—Eastern coal fields.

Distribution of Types.—It is not intended at this point to take up the topic of coal classification in detail. It should be noted, however, that certain geological conditions have brought about chemical changes in the coal beds which have resulted in a progression westward of certain type characteristics such as the content of volatile matter or the amount of free moisture retained in the coal seam. For example, by reference to Fig. 6, the numbers 1 to 3 inclusive show the location of the coals having the lowest volatile matter, the anthracites. Coals numbered

5 to 10 are of the bituminous type but low in volatile matter, while in the next zone westward are found the high-volatile bituminous coals. Further west, as in Indiana and Illinois, other zonal characteristics of a chemical nature occur which will be better understood when the topic of classification is discussed

CHAPTER III

SAMPLING OF COAL¹

Introduction.—Samples may be taken by different methods and for a variety of purposes. Three kinds are generally recognized:

1. Hand samples.
2. Face samples.
3. Commercial samples.

1. *Hand Samples.*—As the name implies, hand samples are taken in small amounts and the entire sample is submitted for inspection and analysis. In the nature of the case such samples are selected and are not representative of the mass from which they come. Their analysis may be of interest to the person collecting them but the results are without commercial value or significance.

2. *Face Samples.*—This term is applied to samples taken at the working face of a coal seam. They are essential for purposes of scientific study and serve as a basis for determining the changes that occur in the process of mining, transportation and storage. The taking of such samples is not different in principle from the taking of commercial samples. The chief essential is a kit of the knock-down type, not too heavy for packing and not too tedious in setting up and operating. Specific details are not given here.

3. *Commercial Samples.*—The majority of samples are taken in connection with industrial operations, in the process of coal inspection, control of contracts, determination of efficiencies, etc., and involves the sampling of wagon loads, car lots, barge shipments and masses in storage. The general principles under any of these conditions are the same. The important features to be observed are given special emphasis as follows:

Necessity of Care.—Without question, the critical point in the entire range of coal inspection and analysis is in the sampling.

¹ Adapted from Ill. State Geol. Surv., *Bull.* 29, Purchase and sale of Illinois coal on specification, by S. W. PARR (1914).

If the sample taken is truly representative of the entire lot, the results, if accurate in themselves, furnish correct information as to the larger mass of which the sample is a part. If, on the other hand, the sample is in error, the results of the analysis though correct in themselves will be in error so far as they relate to the mass under consideration. Throughout the process of sampling two points must be observed with scrupulous care:

First.—The sample taken must be representative of the whole, that is, the distribution of the various substances which go to make up the original mass must be maintained without any change in the relative amount of the various constituents.

Second.—The moisture content, which changes readily, must be under exact control so that at any stage the ratio of moisture present to the original moisture of the mass may be definitely known.

Material to Be Taken.—As stated above, the first essential in a sample is that it shall truly represent the mass of which it is a part. To secure this result a few fundamental conditions must be observed, as follows:

The gross sample must be representative of the various kinds of material present. That is to say, a mass of coal consists of fine stuff, lump, bone, slate, pyrites, and other constituents. As a rule the "fines" differ in composition from the lump, hence the sample must have these two sorts of material in their proper proportion. The same is even more true of slate or pyrites, the composition of which differs widely from that of the major part of the mass. An undue amount of such material would cause a serious disturbance in the accuracy of the sample.

Amount.—In procuring a representative sample a large element of safety resides in the quantity taken. In general, the larger the amount, the more representative it will be. However, conditions differ. It is easier, for example, to procure an even sample from the face of a working vein or from a carload of screenings than from a carload or other mass of lump or run-of-mine coal. In the latter case larger amounts should be taken than in the former.

The limits of practicability for the proper handling of the sample must however be considered. In general, the gross sample should weigh approximately from 200 to 600 lb. Doubt-

less 200 lb. of screenings, taken with fairly good distribution throughout the unloading of a 40- or 50-ton car, will yield a very true sample. The difficulties increase greatly with the increase of the size of the particles, as in the case of lump or mine-run coal. If mechanical appliances for grinding are available, the larger amount should be taken, but a smaller sample well crushed down before quartering is better than a greater mass quartered down while the particles are still in larger pieces.

Ratio of Size to Mass.—Assuming that the sample as taken is made up of the various kinds of material in proper proportion, the next important item is to maintain these variables in their ratios throughout the process of reducing the gross amount to a small working or laboratory sample. To insure this result, there must be maintained a certain ratio of size of the particles to size or weight of the mass. This, as a rule, is based on a formula which provides that the weight of the largest piece of impurity shall have a ratio to the weight of the mass of about 2:10,000. For example, a mass weighing 10,000 grams, or about 22 lb., should contain no particles weighing more than 2 grams. This would mean that the largest particle, as for example, a piece of iron pyrites, must not be over $\frac{1}{4}$ in. in its greatest diameter. Each piece of impurity of this size improperly distributed would represent a possible error of approximately ± 0.02 per cent.

The final ratio of sizes, however, should be determined by the methods available for grinding. With mechanical appliances for obtaining the smaller sizes, a table of ratios with greater safety limits can be adopted than is perhaps practicable where the crushing is done by hand. If a power crusher is available, the entire sample should be passed through the mill and reduced to a size which will pass a $\frac{1}{4}$ -in. screen. If the crushing must be done by hand, the first reduction in size of the particles should be such that the entire mass will pass through a 1-in. screen. When by quartering, the sample is reduced to 100 lb., the size of the particles should be further reduced to a size that will pass a $\frac{1}{2}$ -in. screen, and with a 50-lb. sample in hand the crushing should be carried to $\frac{1}{4}$ -in. mesh. The subdivisions with their respective sizes are shown in tabular form as follows:

TABLE I.—SIZE OF MESH FOR DIFFERENT SUBDIVISIONS OF SAMPLE

Weight of subdivisions of sample (pounds)	Size of mesh to which each sub- division should be broken (inches)
500	1
250	$\frac{3}{4}$
125	$\frac{1}{2}$
60	$\frac{1}{4}$
30	$\frac{1}{8}$

Illinois coals are easily crushed in mills which are available at little expense. Hence, it is entirely reasonable to require that

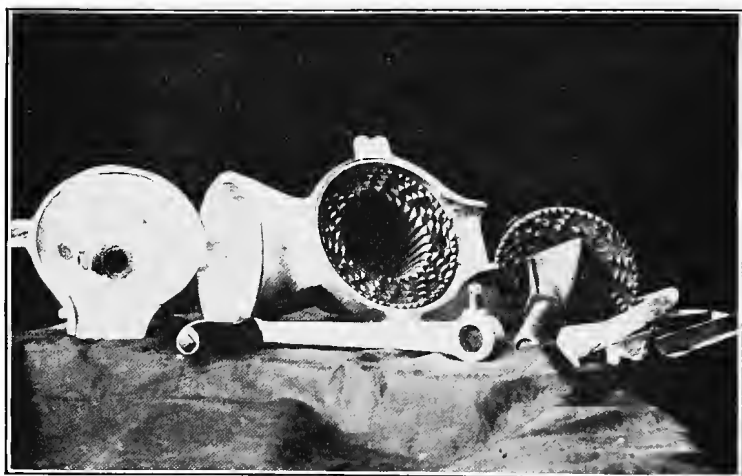
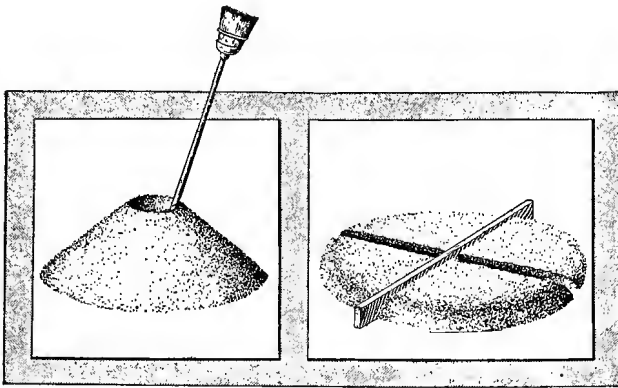

FIG. 7.—Coal grinder of the coffee-mill type.

gross samples, when reduced in mass to 50 or 75 lb., shall be passed through a mill set for grinding to approximately $\frac{1}{8}$ in. For this work, a mill which is not of the jaw crusher or roller type is preferred, since these types produce too large a percentage of fine material, and the harder pieces of slate, especially those of flaky or plate-like structure, are liable to pass in pieces having inadmissably large dimensions in two directions, even though the adjustment used would seem to be fine enough to prevent the passage of such material. A grinder of the coffee-mill type or one with projecting teeth on the grinding surfaces will be found

to produce a more uniform size and the minimum amount of dust. The grinding surfaces of such a machine are shown in Fig. 7.

Mixing and Subdividing.—As a further precaution in maintaining a correct distribution of the various constituents, emphasis is placed upon the necessity of thorough mixing, followed by an even selection of the remaining subdivisions. It is true that fine grinding contributes materially to this end but further care is necessary. It is entirely practicable to mix a 50-lb. sample, ground as above described, by rolling in an oilcloth about 5 ft. square. This is accomplished by taking one corner of the cloth



Figs. 8 and 9.—Flattening the heap of coal and then quartering the pile.

and carrying it over the pile towards the diagonally opposite corner so as to cause the mass to roll over upon itself, then reversing the motion and repeating the process with the other two corners. Fifteen or twenty such alterations, depending somewhat upon the size of the sample, should be sufficient to effect an even mixture. After mixing, the process of coning and quartering should be followed as illustrated in the cut, Figs. 8 and 9. Opposite quarters are rejected until the final sample amounts to about 5 lb. This is sealed in an airtight container, and forwarded to the laboratory for analysis.

The subdividing of the larger sample, to reduce it to a convenient size for transmission to the laboratory, requires special consideration as having an important bearing on the mainte-

nance of the correct ratio of constituents. This may be best shown by the data given in Table II.

TABLE II.—ASH VARIATIONS IN DIFFERENT SIZES OBTAINED FROM DUPLICATE SAMPLES

Series	Mesh	Duplicate halves	Per cent of each size	Ash	<i>a</i> and <i>b</i> composited by calculation	
1 ₁	On 20.....	<i>a</i>	41.7	14.11		
		<i>b</i>	48.4	14.00		
1 ₂	Through 20....	<i>a</i>	41.7	15.55		
	On 60.....	<i>b</i>	37.9	15.42		
1 ₃	Through 60....	<i>a</i>	16.6	23.89		<i>a</i> 16.32
		<i>b</i>	13.7	23.65		<i>b</i> 15.86
						Average..... 16.09
2 ₁	On 20.....	<i>a</i>	29.1	15.91		
		<i>b</i>	25.0	15.68		
2 ₂	Through 20....	<i>a</i>	48.4	16.23		
	On 60.....	<i>b</i>	51.9	16.06		
2 ₃	Through 60....	<i>a</i>	22.5	24.09		<i>a</i> 17.90
		<i>b</i>	23.1	23.98	<i>b</i> 17.80	
					Average..... 17.85	

Note in this table that series 1 and 2 are 3-lb. samples taken by subdividing in the same manner the same gross sample of about 30 lb. Each sample was ground to eight-mesh and sized. It will be seen that in series 1, duplicates *a* and *b* had 16.6 and 13.7 per cent of the 60-mesh size, whereas in series 2 the duplicates *a* and *b* had 22.5 and 23.1 per cent respectively. Note further, the great increase in ash in the fine size as compared with the ash in the coarse material. For example, series 1 having an average of 14 per cent of ash in the coarse size has an average of 23.75 per cent in the fine portion. A similar increase in ash is seen in the corresponding sizes in series 2. The ultimate ash average for series 1 is 16.09 per cent and for series 2 it is 17.85 per cent. These values vary consistently with the variation in the percentages of fine material in the respective series. On the other hand, the duplicate halves *a* and *b* throughout, because of

their uniformity resulting from the sizing process, show result in the several pairs which check very closely.

The values as presented in the table, therefore, show clearly that in the process of subdividing the gross sample and in the further reduction of the sample as received at the laboratory, great care must be exercised to see that no part of the manipulation is of such a nature as will promote segregation of the constituents.

Riffing.—A riffle constructed according to the pattern shown in Fig. 10 may be used to advantage after the sample has been reduced by quartering to about 5 lb. At this stage the sample is

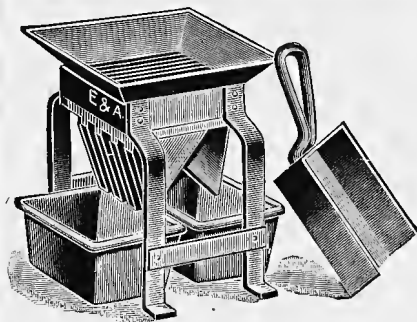

FIG. 10.—Rifle.

ground to $\frac{1}{8}$ -in. size, hence the riffle openings may be $\frac{1}{2}$ in. in width. With this variation in the openings the riffle as shown in Fig. 10 is substantially the one described in the *Bulletin* of the Ohio Geological Survey, No. 9, p. 313, 1908.¹

Segregation may occur where least expected, for example, in the use of a riffle, if the material is added from the scoop more rapidly than it can pass through the openings, thereby piling up in the riffle hopper, the material tends to form itself into cone-shaped masses, down the sides of which the particles may flow more readily in one direction than in another, depending on the freedom of the opening. Such conditions promote marked segregation. Riffles with large hoppers and small grid areas are not of good construction. Numerous tests on this point

¹ See also "Standard Methods" of the American Society for Testing Materials, 1916, p. 552. Also same volume for sampling details, pp. 544-549.

have been made.¹ One set only is given here. The sample No. 1 of Table II, but not separated into the various sizes, shows an ash content of 16.09 per cent. The two halves obtained by proper feeding of the riffle gave 16.07 and 16.26 per cent, or a difference of 0.19 per cent. By rapid feeding, sufficient for the material to pile up in the hopper, the two halves gave ash values of 14.35 and 17.87 per cent respectively, or a difference of 3.52 per cent.

Sampling a Carload.—A car of coal may be sampled to the best advantage in the process of unloading. An occasional half shovelful should be thrown into a proper receptacle so that by the time the car is unloaded approximately 200 lb., evenly distributed throughout the load will have been taken. This will mean about one-half shovelful for every 10 full scoops. They are best taken in the process of shoveling from the bottom of the car, since the top coal rolls down and mixes fairly evenly with the bottom. It should be kept in mind that in taking a sample there must be obtained the different sizes of coal, fine and coarse in their proper proportions from the entire cross-section of the mass, and also an even distribution of the sample lengthwise of the car. Even greater care must be taken to guard against loss of moisture in the process of collecting and in reducing the gross sample for the reason that as a rule the relative humidity outside of the mine is lower and the tendency of the moisture to leave the coal is correspondingly increased.

It has been shown in Table II, that the finer particles of a coal mass are higher in ash and hence have a greater specific gravity. They are therefore more likely to separate by gravity from the coarser material. On this account, if a car is to be sampled without unloading, it is necessary to dig well toward the bottom in order to obtain a representative sample. Three trenches should be dug crosswise of the load, one near each end and one near the middle of the car. These trenches should go down nearly to the bottom of the mass and each size be taken as nearly as possible in its proper proportion. Lump and run-of-mine lots are much more difficult to sample than screenings, but it should be noted that screenings may vary greatly, for not infrequently a car is partially loaded from one bin and finished from another

¹Ill. S. G. S. Coop. Bull. 3, p. 25, 1916.

which may be of a different size and composition. After obtaining the gross sample, the methods to be followed are the same as those already given.

Composite Samples.—It is often desirable to composite a number of samples. In this way a single sample may be made to represent a much larger quantity of coal and thus cut down the time and expense involved in procuring the analytical data. In this procedure, however, it must be remembered that even greater care should be exercised in taking the several component samples. The amount of each sample entering into the composite must be in proportion to the mass which it represents, and finally a thorough and positive mixing of the composited mass must be effected before quartering down the same to the usual 5-lb. quantity.

It is convenient to determine the amount of each sample to be taken by employing an aliquot system of weights. For illustration: Suppose we adopt 1 gram to the 100 lb. as the unit which shall enter into the composite. Then a 100,000-lb. car of coal should be represented by 1,000 grams. In compositing, therefore, the total amount of each sample will not be taken, but instead an aliquot proportion which will give to each car lot its due amount. It is preferable to use such a factor as shall utilize the major part of the several 5-lb. samples. In this way the gross composite from 10 cars would aggregate 20 or 30 lb. in weight. It should be coned and quartered until a thoroughly homogeneous mass of about 5 lb. is obtained, as already described. For this procedure it is obvious that the necessary data should accompany the various samples. A ticket inserted in the can before sealing should give the data needed.

A convenient form is as follows:

From.....	Date.....	19..
(Name of institution)	(When taken)	
Kind of coal		
Car initials.....	Car No.....	
Net weight.....		
Weight taken for composite ¹		
Weight of quarter taken for dust.....		
Weight of dust in quarter taken.....		

¹ Divide the net weight by 2 and place a decimal point after the first figure of the quotient.

Mechanical Sampling.—Numerous attempts have been made to devise a mechanical method for taking samples. While it is possible, by such means to eliminate the personal equation, it is difficult to avoid segregation or an uneven distribution of coarse and fine material. In the sample grinder illustrated in Fig. 11, there is an evident advantage that with such a power grinder larger samples may be handled, thus dividing rather than multiplying the errors. The illustration shows the grinder opened for cleaning, at the end of the operation. Both the central

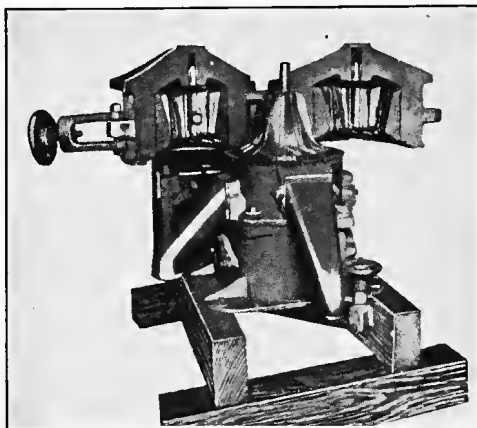

FIG. 11.—Grinder opened for cleaning.

grinding cone and the wing stirrer underneath may be lifted out for cleaning the entire grinding and distributing chamber. The sampling feature is so arranged that an aliquot part, approximately 10 per cent, is delivered into the small receptacle in the process of grinding the original mass. In use of such a sample grinder, the facility with which the material may be passed through makes it possible to take much larger initial samples. For example, if occasional shovelfuls are taken, well distributed throughout the unloading of a car in such an amount as to yield say 40 lb. in the aliquot portion, then it is known that approximately a 400-lb. gross sample has been passed through the grinder.

Doubtless the best method for determining the accuracy of

the sample delivered by the apparatus is to compare the ash values, water-free basis, as obtained from the small sample with the ash value from the main portion, sampled by carefully quartering down by hand in the usual manner. A number of tests of this sort are shown in Table III.

TABLE III.—ACCURACY OF SAMPLE GRINDER

Comparison of ash values. Dry basis

Samples *A* and *B* obtained from main portion by quartering and riffing

Laboratory number	Coal	Ash in small sample as delivered by grinder	<i>A</i> Ash in main portion sampled by quartering and riffing	<i>B</i> Ash in main portion Duplicate of <i>A</i> —opposite quarter
8661	Vermilion Co. Screenings. . . .	15.53	15.22	15.72
8664	Vermilion Co. Screenings. . . .	14.52	14.52	14.65
8667	Vermilion Co. Screenings. . . .	19.19	19.88	19.72
8670	Vermilion Co. Screenings. . . .	17.43	17.78	17.58

Another test has been applied as follows: The samples as obtained in the process of grinding 10 gross samples were delivered into a common receptacle in their proper proportions for compositing. Without further mixing, the mass of approximately 40 lb. was poured into the grinder. The accuracy of the small sample thus obtained was determined as before, by comparison of ash values. The main portion was sampled again by pouring through the mill a second time for a duplicate aliquot delivery. The results are shown in Table IV. In both of these tables the agreement between the sample delivered by the mill and the sample obtained from the main portion is very satisfactory, especially when we consider the variations inherent in the processes of analysis for high-ash coals.

Moisture Control.—The further essential in taking and preparing a sample relates to the free moisture present, and requires that the changes in moisture content “must be under exact control so that at any stage the ratio of the moisture present to the original moisture of the mass may be definitely known.”

In coals of this region especially, where the moisture in the coal as it comes from the mine averages from 10 to 15 per cent the tendency toward moisture changes is very marked. For ex-

TABLE IV.—ACCURACY OF SAMPLE GRINDER

By comparison of ash values. Dry basis

Duplicate sample obtained by second passage of main portion through mill

Laboratory number	Coal (screenings)	A First aliquot of 10 per cent as delivered	B Second aliquot of main portion
8668	Moultrie County.....	19.61	19.60
8934	Moultrie County.....	20.32	20.38
8961	Moultrie County.....	20.94	21.13
8973	Moultrie County.....	19.21	19.82
9011	Moultrie County.....	19.21	19.17
9013	Moultrie County.....	19.62	19.41
9025	Montgomery County.....	13.69	13.44
9143	Moultrie County.....	19.64	19.67
9147	Moultrie County.....	19.83	20.03
9162	Moultrie County.....	20.14	20.26
9160	Montgomery County.....	14.17	13.89
9180	Moultrie County.....	19.32	18.94
9185	Montgomery County.....	13.30	13.48
9195	Moultrie County.....	19.72	19.90
9197	Moultrie County.....	18.61	19.18
9240	Montgomery County.....	13.20	12.95
9242	Moultrie County.....	19.82	19.89
9244	Moultrie County.....	18.93	18.96
9268	Montgomery County.....	13.48	13.43

ample, the process of crushing down the larger sizes affords an opportunity for the escape of moisture. Again, if the coal is spread out on the floor of a hot boiler room or left exposed to currents of air for any length of time there will be a serious change in the moisture factor. Another practice sometimes followed is that of assembling the various increments of the gross sample in a sack or other receptacle permitting a relatively free transmission of air. Samples kept in this manner for any length of time or shipped in such containers will have a moisture content quite different from the original.

The methods employed, therefore, in collecting and reducing a gross sample must have special reference to this tendency on the part of the free moisture to escape. The work should be done

rapidly in a room at or below the normal temperature and, so far as possible, with the use of closed apparatus which admits of the least possible exchange of the contained air. Precautionary measures of this sort should be made at the very outset. The gross sample, which is made up of small increments collected usually over a considerable length of time, should be enclosed in a tight box or clean garbage can having a tightly fitting cover which can be closed and locked against the possibility of change until the time for grinding and reducing.

Dust Determinations.—From the preceding discussion it will be at once obvious that with coals of the Illinois type where high ash of the fine material is a characteristic feature, a specification as to the limit of dust or duff allowable in screenings is often or indeed usually embodied in coal specifications. Dust determinations are not necessary of course on run-of-mine or lump coal.

For obtaining the percentage of dust in screenings or slack a 200-lb. sample as taken in the ordinary procedure is coned and quartered by the standard method. One of the quarters, about 50 lb., is placed in a weighed metal basket and the weight taken. It is then passed through a $\frac{1}{4}$ -in. screen into a second weighed basket. The weight of the material passing through is noted. Both of these factors are placed on a ticket, and both portions of coarse and fine material are rejected.

Divide the weight of the material passing the $\frac{1}{4}$ -in. screen by the total weight of the quarter taken and multiply by 100. This will give the percentage of dust present in the coal. The remainder of the sample should be coned and quartered to about 25 lb. or passed through the sample grinder and then riffled as already described.

Laboratory Sample.—The preceding discussion relates mainly to the taking of the gross sample. Ordinarily it should be about 3 to 5 lb. in amount and sealed in a manner to preclude the possibility of change in moisture content while being transported to the laboratory.

The preparation of the working sample for the laboratory is usually considered as a separate matter from that of the gross sampling of the mass. It should be carried out by the chemist or under his immediate supervision. After taking approximately 100 grams for total moisture as described under "Analy-

sis" in the chapter following, the main sample is air dried to approximately constant weight or to a moisture content of from 2 to 4 per cent and passed through a coffee-mill grinder to reduce it to a size which will pass through a 10-mesh sieve. This is riffled down to about 500 grams and placed in the ball mill for fine grinding. The buckboard may also be used for this purpose, in which case a smaller amount, about 100 grams, should be taken. About 50 grams of the 60-mesh material is placed in a small bottle with rubber stopper from which the samples for analysis are weighed.

It is well to remember that, even under these conditions of storing, changes in the sample occur such as segregation, due to the settling of the heavier particles, oxidation which results in a slight increase of free moisture, and especially if the moisture is high, above 4 or 5 per cent, there is a very appreciable change in the iron pyrites from FeS_2 to $\text{FeSO}_4 + 7\text{H}_2\text{O}$.

CHAPTER IV

ANALYSIS OF COAL

Moisture and Nomenclature.—The topic of moisture control has already been discussed, emphasis having been laid upon the fact that at any stage of the processes the exact ratio of the moisture present to the moisture of the original mass must be definitely known. This implies that moisture changes do occur. Indeed three moisture conditions exist and, since under each condition all of the accompanying factors are modified to meet the specific change in moisture, a special designation is applied to the coal for each one of these conditions.

Coal with all of the normal moisture present is designated as “wet” coal or coal “as-received.” It relates to the moisture at the time of taking the sample. All of the detail of the processes for collecting and reducing the gross sample up to and including the item of sealing and shipping the 5-lb. sample involves the preservation of this initial moisture without loss.

The second moisture status is that wherein the “wet” or “as-received” coal has been dried to a point of substantial equilibrium with the moisture of the air, so that in an atmosphere of average humidity it would take on or lose additional moisture very slowly or not at all. In this condition the coal sample is said to be “air-dry.” This is the condition to which the chemist must bring the sample in order that the processes of finer grinding and weighing may be carried on without change in the moisture factor. Obviously the amount of moisture lost in passing from the “wet” or “as-received” condition to the “air-dry” condition must be carefully measured. The factor thus determined is designated as the “loss on air drying.” By use of it all of the values obtained from analysis of the coal in the “air-dry” state may be calculated to the “wet” or “as-received” condition.

The third condition recognized is that of “dry” coal. This is sometimes designated as the “oven-dry” or “moisture-free”

state. All of the values found for the coal in the "air-dry" condition may be transferred by calculation and made to apply to the coal as "oven-dry." The necessary factor in this case is the loss of moisture obtained from drying the "air-dry" sample at or slightly above steam temperature, as 105°C. for 1 hr. It is not intended here to give directions for carrying out these processes. The terms employed, however, are of so frequent occurrence, and in many cases enter so vitally into a correct understanding of the methods upon which certain values are based in the making of estimates and arriving at fuel settlements that at least a brief reference seems desirable.

Carelessness in the use of these terms leads to much confusion. The chemist and the engineer are not always in agreement as to their meaning. The results as obtained by chemical analysis upon the air-dry sample are of little use to the engineer, whose basis of reference is to the "as-received" or to the "dry" basis. For the purpose of the engineer it is necessary, therefore, to calculate the results which are obtained on the air-dry sample back to the "wet" coal and also to the "dry" basis. These values are the only ones that should be reported. The factors obtained on the "air-dry" basis are for the chemist only, and have no significance for any one else.

It will be evident at once that throughout all of the handling of a coal sample there must be exact control of the free moisture and knowledge of the amount present at the various stages of reference in order that calculations may be made from one basis to another. Two methods are in common use. One takes account of the moisture loss on air drying and again the moisture loss on passing from the "air-dry" to the "oven-dry" or "moisture-free" condition. With these two factors in hand the "total moisture" on the sample as received is derived by calculation. This method requires careful handling of the material in order that no unmeasured losses or accessions of moisture occur in the various operations of grinding, riffing, etc.

The other procedure and the one least liable to error is carried out by taking a "total moisture sample" at once upon opening the 5-lb. laboratory sample. This will be about 100 grams in amount. It should be put through a grinder at once, reducing it to about 10-mesh size, and retained in a sample bottle with

rubber stopper. Five-gram samples are taken for total moisture determinations.

Having thus the total moisture on the coal "as received," the main sample may be air-dried without reference to the loss on air drying. The moisture found on oven drying, and the total "as received" moisture furnish all the data needed for calculating to the two bases for reporting, namely the "as-received" and the "dry" or moisture-free condition.

Calculations.—To calculate the percentage values obtained on "air-dry" coal to the "dry-coal" basis, divide each constituent by $(100 - w)$ in which w is the moisture present in the "air-dry" sample. The moisture factor for the "dry" coal is omitted of course, and the sum of the resulting constituents should total 100 per cent.

To calculate from the "air-dry" values to the "wet," or "as-received" condition multiply each percentage for the "air-dry" state by $(100 - l)$ in which l is the loss on air drying. The moisture factor thus derived plus the loss on air drying equals the total moisture in the "wet" coal. This and the other factors calculated as described should equal 100 per cent. Where a total moisture factor is obtained the calculation is made to the "wet" basis from the "dry" or "moisture-free" state by multiplying the dry values by $(100 - t)$ in which t is the total moisture.

Methods of Analysis.—Coal may be subjected to either the ultimate or proximate method of analysis. In the former, beside the moisture, ash, and sulphur factors, a determination is made of the constituent elements comprising the organic substance of the coal; namely, carbon, hydrogen, nitrogen, and oxygen.

In the proximate method, besides the moisture, ash, and sulphur, there are determined, instead of the elemental substances of the organic part, only volatile matter and fixed carbon. The ultimate analysis furnishes data from which the heat value of the coal can be calculated. The proximate analysis gives the necessary data for judging of the kind and general character of the coal. It is the proximate method which will be chiefly considered, the main object being to discuss the significance of the various factors, methods of calculation, etc. The analytical methods are taken up elsewhere under the directions for the laboratory processes.

General Plan.—The general purpose involved in making a chemical analysis of coal is to furnish a basis for estimating values. In its simplest form it consists in separating the inorganic or non-combustible from the organic or heat-producing material. The following outline may serve as an illustration:

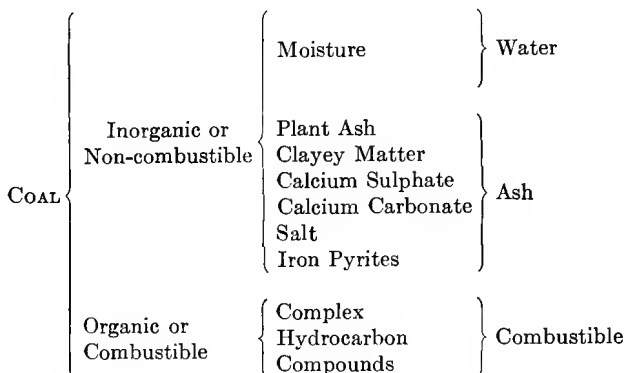

It will be seen from the diagram that the constituents of fundamental importance are in reality only three in number: Water, ash, and combustible matter. The meaning and use of these values especially in some sort of their modified or corrected forms may be made of great service in connection with the purchase and sale of coal on specification.

The Interpretation of Moisture Values.—The significance of the factor for moisture is important. In coals with high moisture in the vein, a large shrinkage in weight occurs in the process of shipment. In the majority of cases, settlement is made upon the basis of the mine weights. This loss of moisture, therefore, falls ultimately upon the consumer.

There is usually a certain agreement also between combined oxygen or the water of constitution and the content of free moisture in the vein sample; the higher the moisture, the more combined oxygen and the smaller the percentage of combustible in the volatile matter. For this reason there are more heat units per pound of combustible (ash and moisture free) in Pocahontas coal, with 2 per cent of vein moisture, than per pound of combustible (ash and moisture free) in Illinois coal, with 12 per cent of moisture in the vein sample. The vein moisture,

therefore, becomes to a very considerable extent an index of the type or composition of the organic part of the coal. These variations in property will be discussed somewhat further under the topic of "Unit Coal."

Ash.—Ash is the inorganic constituent of the coal aside from water. As commonly defined, it is the residue left after burning and is made up of complex substances such as sand, shale or kaolin, gypsum, calcium carbonate, iron pyrites, etc. But, from the list it is evident that there is much opportunity for loss of constituents such as combined water and CO_2 in the process of burning, which, if not corrected for, come to be reckoned as part of the combustible matter. There have come into use, therefore, in connection with the ash determination two terms expressive of this material, namely, "ash as weighed" or simply "ash," and "corrected ash."

The use of a corrected ash factor is primarily of interest in the accurate determination of the amount of active or organic matter present. Thus, unless the line of demarcation between the organic and inorganic substance is properly and precisely drawn, we do not have a correct unit for the true combustible material. This point will be better understood from the discussion of "Unit Coal" in Chapter V.

Sulphur.—This constituent of the coal is made a matter of separate determination. The question might be raised as to whether the sulphur should not be grouped with the true coal substance since it contributes somewhat to the heat values in the burning process. But it is distinctly a mineral substance, varies widely in amount and affects the properties of the coal far more specifically through the ash than in its contribution to the heat volume, which is relatively small in amount. Moreover, by segregating it from the heat producing constituents and taking away the heat also which may be credited to it a far more consistent value remains as the true heat to be credited to the unit-coal substance. This procedure will be found to have very great practical value as well as being of great advantage in the comparative study of coals for classification and similar purposes. Since the sulphur of coal occurs largely as iron pyrites, FeS_2 , it is generally believed that a high sulphur factor represents a high iron factor and, consequently, a tendency for the coal to clinker

in burning. This does not necessarily always follow, but it is true in the main. The average content of sulfur in Illinois coals is from 3 to 4 per cent., with an occasional output as high as 6 or even 7 per cent. In the southern and southeastern field, however, as in Franklin, Williamson, Saline and Jackson counties the sulphur content will average from 1 to 2 per cent.

Volatile Matter.—The organic matter of coal when heated above 350 or 400°C. decomposes giving off combustible gases and, if the temperature is continued to a bright-red heat, there remains, in addition to the ash, the fixed carbon or coking constituent of the coal. The volatile matter is of significance largely by reason of the fact that this part of the combustible substance has a tendency to escape into the flue spaces before complete combustion has been effected. With mechanical stokers and modern equipment, this would not occur and, consequently, the matter of high- or low-volatile matter is of less significance than formerly. In domestic appliances, however, this is not the case, and larger losses occur in the process of combustion. For such uses, therefore, higher efficiency will be obtained from coals with less volatile matter and a higher percentage of fixed carbon.

Fixed Carbon.—The fixed carbon represents the amount of combustible matter which remains behind for complete combustion in the fire box. Its value, therefore, depends upon the form of appliance in which the coal is burned. The fixed carbon plus the ash represents approximately the coke content that might be expected from the original coal. It should be noted that fixed carbon is a product of the destructive distillation of the organic matter of the coal, and is not a constituent of the coal in its natural form at all. Moreover, the fixed carbon carries with it as adsorbed or chemically combined material small percentages of nitrogen, sulphur, hydrogen and possibly oxygen.

CHAPTER V

UNIT COAL

Definitions.—In fuel literature three terms have come into use:

1. Combustible.
2. Ash and water-free substance.
3. Pure coal.

These terms are synonymous and are intended to represent the active or actual coal substance. The heat value, for example, when referred to the combustible matter, is found by dividing the heat value as obtained on the wet coal by 1.00 — (sum of moisture and ash as weighed). From the previous discussion, it is evident that in coals of the Illinois type with their high-ash content there will be a very considerable error unless we make use of a corrected ash, hence there has been suggested¹ another term, that of “Unit Coal,” which is intended to stand for the pure or actual coal substance as derived from taking into consideration the corrected ash. In other words the attempt is made to differentiate between the non-coal substance and the coal itself. The latter is a fairly constant material in its heat producing property and general makeup of its chemical compounds. The non-coal substance on the contrary is made up of a number of ingredients, more or less adventitious, and varying both in actual amount present and also in composition as they pass through the processes of analytical determination. For example the iron pyrites which is a large factor in the non-coal material is weighed out with the coal in the form of FeS_2 . After burning to ash it becomes Fe_2O_3 and the application of a correction factor to the ash as weighed is necessary if we wish to revert to the original condition of the ash. Similarly, the shale or clayey constituents have in chemical combination, a certain amount of water which is not driven off by drying at steam temperature, but is delivered

¹ Univ. of Ill. Eng. Exp. Sta., *Bull.* 37.

at a red heat in the process of ashing. Here again, if we wish to obtain a factor for the true ash or non-coal substance we must apply another correction to account for this loss of combined water. An expression, therefore, for the non-coal substance has been adopted as follows:

Non-coal = Moisture + Ash-as-weighed + $\frac{5}{8}$ S + 0.08 (Ash-as-weighed - $\frac{1}{8}$ ⁰S).

Derivation of the Formula for Unit Coal.—The factors in this expression are derived as follows: In the ash as weighed the FeS_2 of the original coal has burned to Fe_2O_3 . In this combination the atomic ratio of the oxygen to the total sulphur which it replaces, that is Fe_2O_3 , $2(\text{FeS}_2)$: : 48 : 128 or 3 : 8. This means that oxygen has combined with the iron to the extent of three-eighths of the weight of the original sulphur. Hence, the ash as weighed may be corrected or brought to its original form so far as the FeS_2 is concerned by adding five-eighths of the weight of the sulphur present in the coal. The assumption here is that all of the sulphur is present as FeS_2 . Since there is always a certain amount of sulphur present in organic combination, the above factor carries with it a small error which is referred to later in the discussion.

Again the ratio of iron to sulphur in iron pyrites (FeS_2) is 56:64; that is, the amount of iron present is seven-eighths of the weight of the sulphur. The combined iron and oxygen, therefore weighed as Fe_2O_3 are equivalent to $\frac{7}{8} + \frac{3}{8}$ or $\frac{10}{8}$ ⁰ of the sulphur present. Hence, the expression (Ash-as-weighed - $\frac{1}{8}$ ⁰S) represents the ash with the pyritic iron or the resulting oxide Fe_2O_3 removed. Therefore, since the original FeS_2 from which it comes has no combined water, it is subtracted before applying the correction constant of 0.08. This 8 per cent is a constant and represents the water of hydration for the clayey constituents which we wish to restore to the ash as in its original form.

The above formula for "non-coal" becomes therefore the expression for the true coal or "Unit Coal" in percentage values as follows:

Unit Coal = 1.00 - [(Water + Ash-as-weighed + $\frac{5}{8}$ S) + 0.08 (Ash-as-weighed - $\frac{1}{8}$ ⁰S)].

By clearing of fractions and bringing to its simplest form, this expression becomes:

Unit Coal = $1.00 - (W + 1.08A + \frac{3}{4}\text{S})$ in which W is the percentage of water, A is the percentage of ash-as-weighed, and S is the sulphur content.

In this last formula, two corrections are made for iron pyrites by assuming all of the sulphur to be in pyritic form; the first correction $\frac{5}{8}\text{S}$ gives a correction which has an error of the plus order. Similarly the second correction, $\frac{1}{8}\text{S}$, has a similar error, larger than the first, and as these are of opposite signs, they tend to neutralize each other. However, the error involved in $\frac{1}{8}\text{S}$ is greater than in the factor $\frac{5}{8}\text{S}$. There will thus have been subtracted too large an increment in reducing to the final form of $\frac{3}{4}\text{S}$. We shall approach nearer the truth therefore by slightly increasing this value. It will have the added advantage also of convenience in calculating if we increase the factor to $\frac{2}{3}\text{S}$ or $\frac{1}{2}\text{S} + \frac{1}{6}\text{S}$.

The formula as finally devised becomes:

$$\text{Unit Coal} = 1.00 - (W + 1.08A + \frac{2}{3}\text{S})$$

Correction Constant for Water of Composition.—Brief reference should here be made to the correction constant of 0.08 added to the ash as weighed or, as it appears in the final formula, $1.08A$. The need of such a correction is of course more obvious to those working with coals of the mid-continental area where the ash is shaley material which carries always a certain percentage of water of composition not removable by oven drying, but only discharged at a red heat. The value 0.08 was chosen after a number of determinations upon the shales connected with the Illinois coal measures of the content of combined water.

Accuracy of the Constants Employed for Correction of Ash.—It is evident that the factors adopted for correction of the ash are largely empirical. The ultimate evidence as to their suitability therefore will be cumulative, resulting from an extended application. Such evidence will appear under subsequent headings. One of the more direct methods for testing their accuracy is given here as follows:

Suppose a sample of coal, ground to about 10-mesh, is separated by the usual methods into "sink" and "float" material. A solution of zinc chloride is made up to a specific gravity slightly under that of the coal. By stirring the coal sample into such a solution, usually 1.35 sp. gr., the heavier particles, containing

the larger part of the ash, "sink" to the bottom, and the particles with lower ash "float." In this manner a coal sample may be resolved into two parts, one having a high ash, and the other having a low ash. If now we obtain the calorific value on the unit-coal basis, the factors when applied to the high-ash material, if correctly devised, will show a substantial agreement with the heat values for the unit coal of the low-ash division. On the other hand, if these factors are wrong, their application to the high-ash values will accentuate the error and show a wide discrepancy in the heat values for the unit coal of each subdivision. Again, if we can produce a wide variation in the sulfur content, the calculation for unit coal, which of course is sulphur-free, will accentuate any error in the correction factors adopted for that constituent. In this manner, both the correction values for sulphur, to account for iron pyrites, and for the hydration of the high-shale content of the ash, are given a test. Reference to Table V will show the results obtained on a number of "float" and "sink" samples as thus described.

Other evidence in detail has accumulated in verification of the constancy of unit-coal values, especially for a given mine or

TABLE V.—UNIT-COAL HEAT VALUES FOR FLOAT AND SINK SAMPLES

No.	Description of sample	Moist-ure	Ash	Sul-phur	B.t.u. as re-ceived	B.t.u. for unit coal	Dif-ference	
1	Grundy County, Ill.	Float	0.0	4.57	1.44	13,475	14,217	45
		Sink	0.0	21.99	5.00	10,733	14,262	
2	Williamson County, Ill.	Float	0.0	4.08	0.99	13,942	14,615	16
		Sink	0.0	17.75	1.15	11,766	14,599	
3	Williamson County, Ill.	Float	0.0	4.34	1.07	13,970	14,690	23
		Sink	0.0	18.23	1.37	11,731	14,667	
4	Sangamon County, Ill.	Float	0.0	6.12	3.20	13,300	14,340	9
		Sink	0.0	11.66	5.99	12,356	14,331	
5	Sangamon County, Ill.	Float	0.0	8.13	2.95	13,045	14,392	50
		Sink	0.0	18.21	4.25	11,478	14,442	
6	Peoria County, Ill.	Float	2.17	8.26	2.61	12,612	14,268	47
		Sink	1.70	35.08	5.88	8,426	14,221	
7	South Africa	Float	1.63	6.06	1.38	13,793	15,065	28
		Sink	1.66	18.94	2.28	11,680	15,093	
8	South Africa	Float	2.07	8.88	0.87	12,989	14,779	20
		Sink	1.82	15.24	1.80	11,847	14,799	
9	South Africa	Float	1.70	11.12	0.72	12,628	14,638	72
		Sink	1.87	20.20	0.75	11,092	14,566	

county or region, and thus, also incidentally affording a consistent index of subclassifications which cannot be obtained by any other method. The following references contain a considerable amount of such data together with illustrative applications to which unit coal values may be applied:

PARR, S. W. and WHEELER, W. F., Unit coal and the composition of Coal Ash: Univ. of Ill. Eng. Exp. Sta., *Bull.* **37** (1909).

PARR, S. W., Purchase and sale of Illinois coal on specification: Ill. State Geol. Surv., *Bull.* **29** (1914).

PARR, S. W., Chemical study of Illinois coals: Cooperative investigations, I. S. G. S., Univ. of Ill. Eng. Exp. Sta., and U. S. Bureau of Mines, *Bull.* **3** (1916)

CHAPTER VI

CALORIMETRIC MEASUREMENTS

Definitions.—Heat values are expressed in two ways—as Calories and as British thermal units. Only the large Calorie is made use of in fuel reference and it represents the amount of heat necessary to raise 1 kilo of water through 1°C. The full expression is, therefore, Calories per kilo or kilo-Calories.

The British thermal unit represents the amount of heat necessary to raise 1 lb. of water through 1°F. The full expression, therefore, would be B.t.u. per pound.

Since the Centigrade degree is $\frac{9}{5}$ or 1.8 times as great as the Fahrenheit degree, and the kilo is 2.2046 times the pound, it follows that 1 Cal. would be the equivalent in Fahrenheit degrees of 1.8×2.2046 or 3.968 B.t.u. However, the comparison between units as thus developed is not a comparison between values as made use of in the case of fuels for the reason that the arbitrary amount of coal to which reference is made in both cases is an amount of coal equal to the unit of water taken, that is a kilo of coal to a kilo of water, a pound of coal to the pound of water. For this reason, therefore, the rise in temperature in each case is the same. That is, a pound of coal will raise the temperature of a pound of water through as many degrees as a kilo of coal will raise a kilo of water, or a ton of coal a ton of water, etc. The difference in heat values as expressed by these two methods, therefore, is simply the difference in the thermometric readings. A reading taken by the Fahrenheit scale will be $\frac{9}{5}$ or 1.8 times as great as the reading taken by the Centigrade scale. Therefore, to change fuel values expressed in Calories per kilo to B.t.u. per pound, multiply by 1.8.

This relation of 1 : 1.8, it should be observed, refers to solid or liquid fuels only, that is, where the ratio of fuel to total water is that of equivalent quantities. Fortunately, this relationship applies to Continental values as well as English and American,

so that the transfer from Calories to B.t.u. is simple and universally applicable for such material. The matter is quite different, however, in the case of gaseous fuels where the unit quantity of reference is not the same. For example, the B.t.u. value of a cubic foot of gas must be divided by 3.968 to find the equivalent in calories per cubic foot. Then since there are 35.314 cu. ft. in 1 cubic meter, the expression for transferring gas values from B.t.u. per cubic foot to calories per cubic meter would be

$$\text{B.t.u. per cu. ft.} \times \frac{35.314}{3.968} = \text{Cal. per cubic meter}$$

$$\text{B.t.u. per cu. ft.} \times 8.8997 = \text{Cal. per cubic meter.}$$

Heat Values by Calculation.—Heat values may be determined from the ultimate analysis by Dulong's formula, which assumes that the heat comes from the combustion of carbon, hydrogen, and sulphur. The usual values for these constituents are

$$\text{Carbon} = 8,080 \text{ Cal. or } 14,544 \text{ B.t.u.}$$

$$\text{Hydrogen} = 34,500 \text{ Cal. or } 62,100 \text{ B.t.u.}$$

$$\text{Sulphur} = 2,500 \text{ Cal. or } 4,500 \text{ B.t.u.}$$

Expressed in the latter set of values, therefore, Dulong's formula becomes

$$14,544C + 62,100 \left(H - \frac{O}{8} \right) + 4,500S = \text{B.t.u.}$$

In this formula the expression $(H - \frac{O}{8})$ represents what is termed the available hydrogen; that is, the amount left after subtracting the equivalent hydrogen needed to unite with the oxygen present to form water, 2:16 or $\frac{1}{8}O$.

Presumably such calculated values would be in close agreement with indicated values by means of a carefully operated instrument. This is true for certain regions but not for others. The divergence is more pronounced in coals of the Illinois region than in the coals of the eastern United States. "In view of the possible presence of calcium carbonate and the consequent error in the ash determination for many Illinois coals, it is evident that a direct variable in such cases enters into the value for oxygen and consequently for the available hydrogen, which would thereby result in a discrepancy as between the indicated and the calculated calorific values. Moreover, a high percentage of oxygen

in combination evidently may be responsible for variations of quite a different character, as, for example, a different distribution of such oxygen in a manner not altogether correctly covered by the expression $\frac{O}{8}$, or in the ultimate form of water. There

seems to be, therefore, numerous reasons why a calculated calorific value by use of Dulong's formula is of little value for coals of this type."¹

The Berthier Test.—The Berthier test is based on the property of carbon to reduce the oxide of lead at a red heat. The higher the percentage of combustible present, the larger the button. One gram of coal is mixed with 60 grams of litharge and heated to redness in a crucible. The weight of the button thus obtained is multiplied by 421. The product represents theoretically the reducing power of the carbon in terms of British thermal units. It should be increased by about the value of the available hydrogen present. In Illinois coals this does not vary widely from 3.5 per cent, making the addition of a constant necessary of about 2,000 B.t.u. The results thus obtained may vary from the truth by 300 to 800 units, or from 3 to 8 per cent. The method has historical rather than practical interest.

Lewis Thompson Calorimeter.—This is a bell shaped receptacle for submerging in water and containing within the bell a cartridge having a mixture of coal, 2 grams; with 22 grams of a mixture of potassium nitrate 3 parts, and potassium chlorate, 1 part.² According to Schöerer-Kestner³ this apparatus normally gives results that are in error by about 15 per cent. This apparatus also dates back to a time when a mere approximation to the correct values was all that seemed to be demanded by fuel users. At the present time a degree of exactness is required which was impossible with either of the methods just described.

Other Types.—There are two types of calorimeters using oxygen as a medium for carrying on the combustion—those in which the oxygen is maintained at atmospheric pressure and

¹ PARR, S. W., Ill. State Geol. Surv., *Yearbook*, p. 236, 1909.

Also, PORTER and OVITZ, Bureau of Mines, *Bull.* 1, p. 28-29.

² For details of the apparatus see "Fuel, Water and Gas Analysis," by KERSHAW.

³ *Jour. Soc. Chem. Ind.*, vol. 7, p. 869.

those using oxygen under approximately 25 atmospheres. The first condition is referred to as that of constant pressure and the second as that of constant volume.

Of the first type, the best known perhaps are Fischer's, Carpenter's, W. Thompson's, etc., which conduct a current of oxygen into a chamber containing the fuel. The chief disadvantage results from imperfect combustion, especially with high-ash coals due to fusion of the ash with consequent enclosure and protection of the carbonaceous matter from further oxidation.

Oxygen Bomb Calorimeter.—Calorimeters using oxygen at approximately 25 atmospheres pressure are designated as of the Berthelot or Mahler type from the names of the investigators who were pioneers in their development and use. A typical bomb of this type is shown in Fig. 12. A carefully weighed amount of coal is held in a capsule within the bomb. The bomb after charging is placed in the can, Fig. 36 and a known quantity of water added. After placing in the insulated receptacle, and putting in place the cover, an equalization of the temperature is brought about by rotation of the stirrer. After ignition and equalization again of the temperature, the factors are at hand for deriving the heat value of the coal according to the formula:

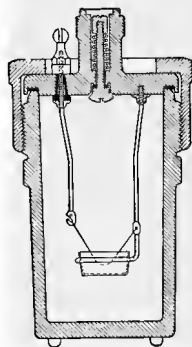

FIG. 12.—Oxygen bomb.

$$\text{B.t.u.} = \frac{\text{rise} \times \text{total water}}{\text{weight of coal}}$$

For example, if 1 gram of coal were taken and the total water used, including the water equivalent of the apparatus, were 2,400 grams, then for a rise of say, 4°F. the heat value would be 9,600 B.t.u. By this procedure, therefore, may be found the rise in temperature which a given weight of coal will impart to an equivalent weight of water, thus satisfying the conditions of the definition of the British thermal units per pound of fuel.

Also as already noted under "Definitions," in this same example, if a Centigrade scale were used the rise in temperature would be 2.222° which by introducing into the computation would give 5,333 Cal., the temperature rise in Centigrade

degrees that a given amount of this fuel would impart to an equivalent weight of water.

Note especially, that in all the discussions pertaining to the oxygen bomb it is assumed that the Centigrade scale is used and the final values are in Calories. If, finally, the values are wanted in B.t.u. the factor 1.8 is applied.

Correction for Radiation.—If the system containing the bomb and measured quantity of water is operated at a temperature above or below that of the room, a gain or loss of heat will result due to radiation. This may be corrected for in a very accurate manner by taking the thermometer readings each minute for a preliminary period of 5 min. and also for a final period of 5 min., with an intervening period usually of about 5 min. The rates of radiation change thus obtained are incorporated into a formula covering the period of combustion and equalization of the system as follows:

The rate of rise for the preliminary period is r_1 and for the final period is r_2 . The time readings are indicated as a , b and c . At a is noted the time of ignition. At c the time of final or maximum reading, and at b the time when the thermometer has reached the point of rise equivalent to six-tenths of the total between a and c . In computing, the rate r_1 is multiplied by the time $b - a$, in minutes and tenths of a minute, and this product is added to the temperature reading at a . Similarly the rate r_2 is multiplied by the time interval $c - b$ and the product added to the time c . Assuming that the thermometer corrections for stem and setting have already been made, the difference of the two thermometer readings thus corrected give the total rise of temperature due to combustion. If the temperature was falling at the time a , then the system is losing instead of gaining heat, and the correction is minus instead of plus, a reduction of the subtrahend operating as a plus correction. Similarly, if the temperature is rising at the time c , the system is gaining heat and the correction for the period $c - b$ should be minus instead of plus. In the case of coals where the approximate total rise is unknown, and hence the time reading b at the six-tenths point uncertain, it is only necessary to take readings at 15-sec. intervals for approximately 2 min. These observations will enable one to readily locate the six-tenth point when all the readings are

completed. This formula has been devised by Dr. Dickinson of the U. S. Bureau of Standards,¹ and has been adopted by the joint committee of the American Chemical Society and the American Society for Testing Materials on Standard Methods for Coal Analysis.² It is exceedingly convenient and accurate, and in the report of the committee, entirely replaces the very elaborate and tedious method of Pfaundler.³

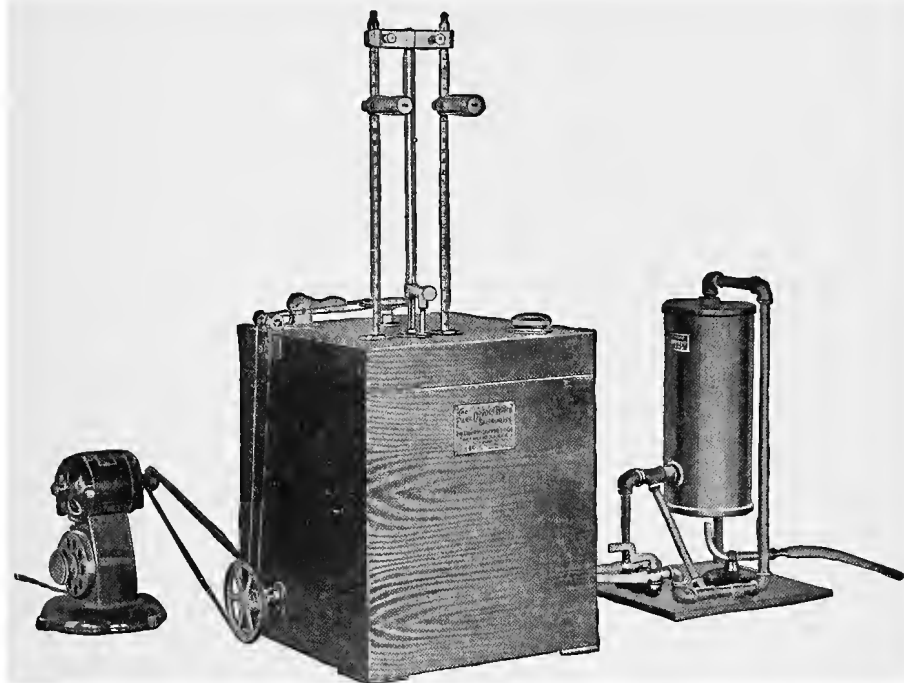

FIG. 13.—A calorimeter of the adiabatic type.

Adiabatic Insulation.—To avoid the necessity of accounting for radiation losses and eliminating possible errors, as also to simplify the matter of readings and calculations, various methods of insulation involving adiabatic conditions have been developed.

¹ U. S. Bureau of Standards, *Scientific Paper*, 230.

² Am. Soc. for Testing Mat., "Standards," p. 576, 1916.

³ For an excellent presentation of the Pfaundler formula see WHITE'S "Gas and Fuel Analysis," 2d ed., p. 268, 1920, or 1st ed., p. 224, 1913.

To be thoroughly effective these methods should involve com-

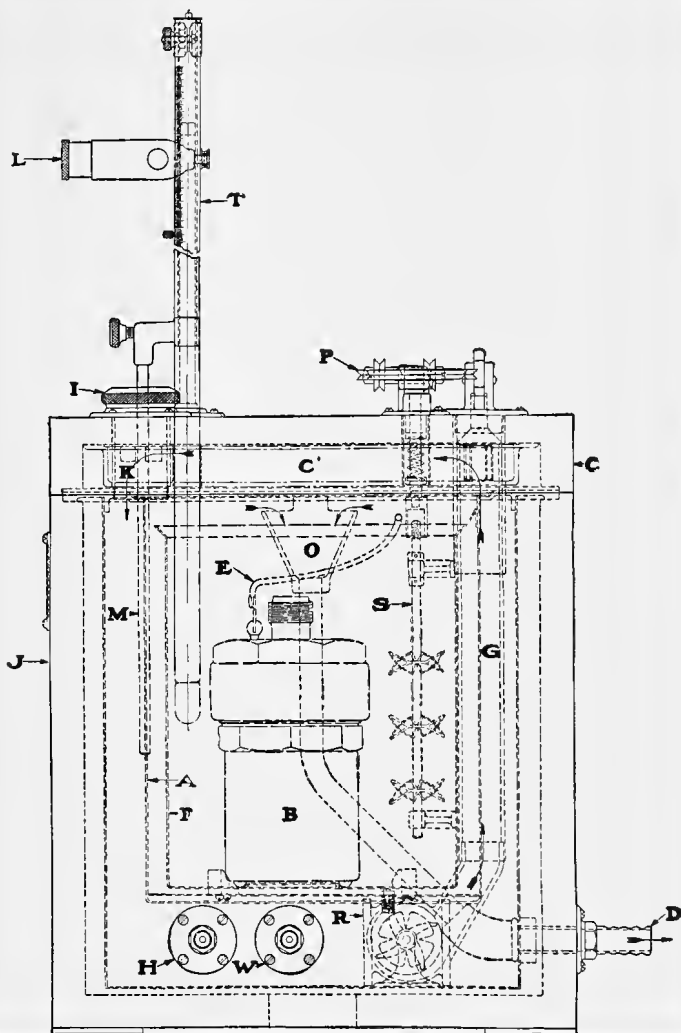

FIG. 14.—The adiabatic calorimeter showing details of construction.

plete control over the temperature of the insulating part of the apparatus in such a way as to cause the temperature to rise

coordinately with that of the combustion system. Such instruments are designated as adiabatic calorimeters. Their greater convenience of operation and possibilities of extreme accuracy are apparent.

In the instrument here illustrated, Fig. 14, the water is circulated by means of the stirrer *R*, which includes also a small turbine for directing a portion of the water upward in *G*, and thus through the lid *C*. In this manner the jacketing water is distributed on all sides, above and below the container *F* with the bomb *B*.

Correction for Acids.—One other condition exists in the use of the Mahler type of calorimeter which requires consideration. Because of the use of pure oxygen at a high pressure and temperature, certain reactions take place which do not occur in the ordinary process of combustion. For example, a small amount of residual air present upon closing the instrument has free nitrogen which under the conditions of combustion is partially oxidized to N_2O_5 or with the moisture present in the bomb it becomes HNO_3 . Similarly the nitrogen of the coal burns to a greater or less extent to HNO_3 . The sulphur in the coal which under ordinary conditions of combustion burns to SO_2 , in the calorimeter burns to SO_3 or with the moisture present, to H_2SO_4 . These two highly corroding acids make it necessary to protect the interior surface of the bomb. This is accomplished by use of an enamel, by a spun lining of gold or platinum, or by constructing the bomb of an acid resisting alloy equivalent in that respect to gold or platinum. Where such a precaution is disregarded, as for example, if the enamel type of protection becomes cracked and scaled off or if a lining of spun metal such as nickel is employed, the solvent property of the acids becomes active. There are two sources of error which result from such conditions—one is the heat of solution resulting from the chemical action. This of course should not be credited to the heat content of the coal. It would be relatively small in amount, probably not exceeding 5 to 10 cal. The other is the masking of the amount of free acid which thus escapes measurement and would be uncorrected for. In high-sulphur coals of the Illinois type the error from this source may be of considerable moment, frequently equaling or even exceeding 100 cal.

The amount of free acid in the bomb washings is first determined by means of a standard solution of Na_2CO_3 made up of such a strength that each cubic centimeter represents 1 cal. The heat of formation for HNO_3 is 1,035 cal. per gram of nitrogen. The reaction for neutralization is:

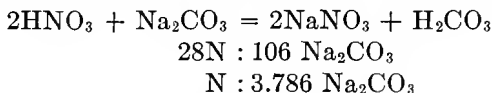

That is 1 gram N, burning to HNO_3 and representing 1,035 cal., requires 3.786 grams Na_2CO_3 . One calorie requires 0.003658 gram of Na_2CO_3 or 3.658 grams per liter in which 1 cc. would represent 1 cal.

In the calculation thus far it has been assumed that all of the acid present was HNO_3 . The H_2SO_4 must be taken into the account.

When sulphur burns to SO_3 aqua, it develops approximately 4,450 cal. per gram of S. In ordinary combustion the burning to SO_2 generates only 2,250 cal. per gram. The excess heat resulting from conditions within the bomb would be represented by $4,450 - 2,250 = 2,200$ cal. per gram of S. But the titration for 1 gram of N as HNO_3 would represent only seven-eighths of a gram of S as H_2SO_4 . This is evident from the ratio:

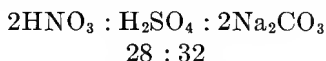

Hence, the titration as HNO_3 for the H_2SO_4 would be only seven-eighths of the heat to be credited to the sulphur per gram. This means that seven-eighths of the 1,035 cal. or 900 cal. per gram of sulphur have been corrected for. Hence, $2,200 - 900$ or 1,300 would represent the additional correction required for 1 gram of sulphur or 13 cal. per 0.01 gram of sulphur, equivalent to 13 cal. additional for each per cent of sulphur present in the coal.

It is at once obvious that the acid correction is a matter of some moment. Illinois coals having from 3 to 5 per cent of sulphur will show a titration of from 35 to 50 c.c. of the standard alkali representing an equivalent number of calories reckoned as HNO_3 , aqua. A coal having 4 per cent of sulphur would have

that correction augmented by 4×13 or 52 cal., or a correction on account of the two acids of from 85 to 125 cal. or from 150 to 225 B.t.u.

In the above considerations all of the sulphur present is supposed to be in the form of organic sulphur or FeS_2 , and to burn to H_2SO_4 . Badly weathered coal may have an appreciable amount of the FeS_2 weathered to $\text{Fe}_2(\text{SO}_4)_3$, but in open bins this will be practically eliminated by leaching.

For complete combustion to H_2SO_4 it is also well to note that sufficient nitrogen must be present to furnish a proper amount of N_2O_5 as catalyzer for the sulphur.¹

The correction in calories for the acids formed together with the correction for fuse-wire are subtracted from the total observed calories.

Correction for Fuse Wire.—The coal in the bomb is ignited by a fuse of iron wire, Brown and Sharpe gage No. 34, and 7 cm. in length. The weight of wire burned is determined with sufficient accuracy by measuring the length of the unburned wire. The weight of the total length will be sufficiently constant so that repeated weighings are not necessary. The total observed calories are corrected by subtracting for the iron at the rate of 1,600 cal. per gram of wire burned.

The Peroxide Calorimeter.—Another type of calorimeter, Fig. 30, is extensively used in which the coal is mixed with a chemical which will supply the oxygen to complete the combustion within a closed cartridge. This method is more conveniently available perhaps for technical work. The procedure is described under the directions for calorimetric measurements (Part II, p. 149). With this instrument the Fahrenheit scale is more commonly employed.

The principles involved are as follows: Sodium peroxide, Na_2O_2 , when mixed with coal in suitable proportion and ignited, may be made to burn or react through an appreciable period of time but, instead of the formation of gaseous products as in the ordinary process of combustion, the CO_2 and H_2O unite with the chemical employed to form the carbonate and hydrate of sodium, which are solids. These reactions shown in detail are as follows:

¹ *Jour. Ind. and Eng. Chem.*, vol. 16, p. 812, 1914.

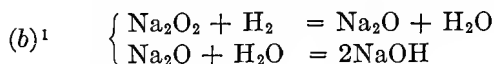
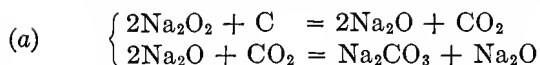

Of the total heat developed in the reactions under (a), 0.73 represents the heat of combination between the carbon and oxygen. Also, under (b), the total heat of the reactions is made up of 73 parts, which includes the heat formed by the union of the hydrogen with the oxygen, and 27 parts, which represents the secondary reaction or combination of the water with the chemical. This distribution of heat values is fortunate for the reason that we may make the factor 0.73 a constant which represents the part of the total heat to be taken as the equivalent of the heat of ordinary combustion. Other corrections must be applied to the indicated rise in temperature as detailed in the method of operation (Part II, p. 155). A brief discussion having reference to the reason for applying the corrections is here given.

First.—The ignition is effected by an electrically heated fuse wire. The amount of heat introduced by the electric current and combustion of the wire is found to be 0.005°F.

Second.—The combination of the ash with the sodium peroxide, forming in the main sodium and aluminum silicates, is attended with a slight increment of temperature which is found by direct experiment to amount to 0.005°F. for each per cent of ash present in the fuel.

Third.—The sulphur in ordinary combustion burns to sulphur dioxide, SO_2 , while in the reaction with the chemical the ultimate result is Na_2SO_4 . The difference in the heat resulting from the two reactions should be subtracted from the indicated temperature. The amount of the correction is determined by burning pure iron pyrites, FeS_2 , in the apparatus and comparing the heat evolved with the accepted heat value for the combustion of an equivalent amount of sulphur to SO_2 .² The difference is found

¹ The complete reactions involved are probably expressed by the equation $\text{Na}_2\text{O}_2 + \text{Na}_2\text{O} + \text{O} + 4\text{H} = 4\text{NaOH}$. See The constants of the Parr calorimeter, *Jour. Am. Chem. Soc.*, vol. 19, p. 1616.

² *Loc. cit.*, p. 1620.

to be equivalent to 0.010°F. for each per cent of sulphur present in the coal.

Fourth.—For the more perfect combustion of all types of coal and also for supplying the seemingly needed free or nascent oxygen for the combustion of the hydrogen, an accelerator is used in conjunction with the sodium peroxide, preferably chlorate of potash, finely pulverized and dry. The heat of decomposition of this material plus the recombination of the free oxygen with the Na_2O resulting from the reactions with carbon amount to 0.270°F. per gram of KClO_3 used.

The indicated rise of temperature is, therefore, first corrected for the several components enumerated, and the corrected rise is used in the formula:

$$\text{B.t.u.} = \frac{r \times w \times 0.73}{C}$$

in which r is the corrected rise in temperature, w is the water equivalent of the water and metal of the apparatus, 2,123.3 grams, and C is the weight of coal taken, 0.5 gram. This will give us the rise in degrees Fahrenheit or B.t.u. which an equal weight of coal will yield upon combustion, provided the actual heat of combustion is imparted to an equivalent of water.

Since, in the above formula the factors for w , C , and the constant 0.73 occur in all cases, their resulting value becomes a constant equal to 3,100. Thus,

$$\frac{2,123.3 \times 0.73}{0.5} = 3,100$$

Gross and Net Heat Values.—In all of the calorimetric considerations thus far the results as computed give the gross values, that is, with the products of combustion reduced in temperature to approximately that of the surrounding air, 20 to 35°C. This means that the water formed in the reactions has given up to the system its latent heat of vaporization. The weight of water is (hydrogen \times 9) and the weight of water \times 0.600 represents the latent heat of vaporization in calories to be subtracted from the observed calories. The remainder is the net heat value.

There is not a little disagreement as to which value, the gross or net, is the more important. In ordinary steam generating

installations where the flue gases are delivered above the point of condensation, the net values would seem to be required. The engineer however in developing his heat balance takes into account the heat of vaporization of all of the moisture, whether free or formed in the reactions, and it is simpler therefore to charge all such heat to the total or gross heat of the coal. It is desirable on this account that he be furnished the hydrogen factor as one of the constituents of the chemical analysis. This requires an ultimate analysis of the coal, or a simplified procedure as described in the following chapter.

Partial bibliography relating to coal calorimetry.

LORD and SOMERMEIER, Ohio State Geol. Surv., 4th ser., *Bull.* 9, p. 320.

ATWATER, *Jour. Am. Chem. Soc.*, vol. 25, p. 659.

PARR, S. W., *Jour. Am. Chem. Soc.*, vol. 29, p. 1606.

PARR, S. W., *Jour. Ind. and Eng. Chem.*, vol. 1, No. 9, p. 673.

FRIES, J. A., Investigations in the use of the bomb calorimeter: U. S. Dept. Ag., *Bull.* 94, 1907.

SOMERMEIER, E. E., "Coal, Its Composition, Analysis, etc.," 1912.

WHITE, A. H., "Technical Gas and Fuel Analysis," 1914.

DICKINSON, H. C., U. S. Bureau of Standards, *Scientific Paper*, No. 230.

REGISTER, S. A., The function of nitrogen in the bomb calorimeter: *Jour. Ind. and Eng. Chem.*, vol. 6, p. 812.

Report of the Committee E-4, Methods of sampling and analysis of coal: *Proc. Am. Soc. for Testing Mat.*, vol. 14, p. 444, 1914; *Jour. Ind. and Eng. Chem.*, vol. 5, p. 517, 1913. Also *Am. Soc. for Testing Mat.*, "Standards," p. 550, 1916.

CHAPTER VII

ULTIMATE ANALYSIS

Total Carbon.—As a substitute for the elaborate and not always satisfactory ultimate analysis of coal the following method will be found both convenient and accurate, fully meeting the requirements of the engineer in boiler-testing computations.

The carbon content of coal may be readily determined from the fusion with sodium peroxide resulting from the calorimetric determinations making use of that process. Combustions with Na_2O_2 may also be made in a simple piece of apparatus devised for that purpose and not involving the elaborations necessary where temperature readings are involved. Figure 40 shows the apparatus for obtaining the fusions.

After the reaction is completed, the fusion cup is transferred to a beaker, the contents dissolved and transferred with thorough washing and as little contact with air as possible to the apparatus shown in Fig. 43. Details of manipulation are given in Part II. The results enable us to derive with a high degree of accuracy the factor for carbon.

Derivation of Hydrogen by Calculation.—In the calculations for deriving a heat balance, the engineer requires the factor for the total hydrogen in the coal used. The hydrogen present is considered as combined in two different ways. In one, the hydrogen is “disposable” or “available” for combustion. In the other it is supposed to be joined with oxygen to form H_2O and when thus combined is not available for the production of heat. The available hydrogen may be derived as follows: If we let C represent the percentage of total carbon, then 14,544C will equal the heat value for that constituent. To this add the heat value of the sulphur present, 5,000S. The remainder of the heat is due to the combustion of hydrogen. Hence, with a value for hydrogen of 62,100 the percentage of available hydrogen H, will be represented by the expression:

$$H = \frac{\text{B.t.u.} - (14,544C + 5,000S)}{62,100}$$

The hydrogen not available or considered to be in combination with oxygen is estimated as one-eighth of the oxygen or $\frac{O}{8}$ as in Dulong's formula. There is required, therefore, the percentage of oxygen and this is determined by difference. That is, if we subtract from 100 the values for ash, sulphur, total carbon, available hydrogen, and nitrogen, the difference will be the non-available hydrogen and oxygen present in the ratio of $H_2 : O$. Hence one-ninth of this difference is H_2 and eight-ninths is the oxygen percentage. That is, the percentage of chemically combined water is represented by the formula:

$$H_2O = 100 - (A + S + C + \text{available } H + N)$$

The only undetermined factor in the above expression is that for nitrogen. It may be determined directly by the Kjeldahl method, or, for purposes of calculating a heat balance it is quite sufficiently accurate to assume a value of 1 per cent for nitrogen, since the amount present in bituminous coals varies only within relatively narrow limits, say from 0.75 to 1.50 per cent. These calculations can also be made to good advantage by basing the factors upon the pure combustible or "Unit Coal" described in Chapter V. The final results however are not essentially different. It is especially to be noted that in this treatise, all reference to oxygen and hydrogen in coal is on the assumption that the free moisture is separately determined by drying at 105°C . and reported as moisture. The hydrogen and oxygen of the free moisture therefore do not appear as constituents of the coal.

CHAPTER VIII

CLASSIFICATION OF COALS

Frazer's Classification.¹—The classification of coal in common use was outlined by Frazer in 1877 and was based on his study of the coals of Pennsylvania. A wider knowledge of the character of western and mid-continental deposits calls for the addition of a few subdivisions. In tabular form the following classification based on that of Frazer most nearly approaches everyday usage:

COALS	{	Anthracites,	Volatile matter, below 5 per cent				
		Semi-anthracites,	Vol., 5-10 per cent				
		Semi-bituminous, (Pocahontas)	Vol., 15-22 per cent				
		Bituminous	<table style="border-collapse: collapse; margin-left: 20px;"> <tr> <td style="padding: 5px;">Eastern,</td> <td style="padding: 5px;">{ Vol., 25-35 per cent Vein Moist., 2-4 per cent</td> </tr> <tr> <td style="padding: 5px;">Mid-Con- tinental,</td> <td style="padding: 5px;">{ Vol., 35-45 per cent Vein Moist., 6-17 per cent</td> </tr> </table>	Eastern,	{ Vol., 25-35 per cent Vein Moist., 2-4 per cent	Mid-Con- tinental,	{ Vol., 35-45 per cent Vein Moist., 6-17 per cent
		Eastern,	{ Vol., 25-35 per cent Vein Moist., 2-4 per cent				
		Mid-Con- tinental,	{ Vol., 35-45 per cent Vein Moist., 6-17 per cent				
		Black Lignites, or Sub-bituminous	<table style="border-collapse: collapse; margin-left: 20px;"> <tr> <td style="padding: 5px;">{ Vol., 35-45 per cent Vein Moist., 17-20 per cent</td> </tr> <tr> <td style="padding: 5px;">{ Vol., 25-45 per cent Vein Moist., 20-25 per cent</td> </tr> </table>	{ Vol., 35-45 per cent Vein Moist., 17-20 per cent	{ Vol., 25-45 per cent Vein Moist., 20-25 per cent		
{ Vol., 35-45 per cent Vein Moist., 17-20 per cent							
{ Vol., 25-45 per cent Vein Moist., 20-25 per cent							
Brown Lignites,	<table style="border-collapse: collapse; margin-left: 20px;"> <tr> <td style="padding: 5px;">{ Vol., 35-45 per cent Vein Moist., 17-20 per cent</td> </tr> <tr> <td style="padding: 5px;">{ Vol., 25-45 per cent Vein Moist., 20-25 per cent</td> </tr> </table>	{ Vol., 35-45 per cent Vein Moist., 17-20 per cent	{ Vol., 25-45 per cent Vein Moist., 20-25 per cent				
{ Vol., 35-45 per cent Vein Moist., 17-20 per cent							
{ Vol., 25-45 per cent Vein Moist., 20-25 per cent							
.	<table style="border-collapse: collapse; margin-left: 20px;"> <tr> <td style="padding: 5px;">{ Vol., 25-45 per cent Vein Moist., 20-25 per cent</td> </tr> </table>	{ Vol., 25-45 per cent Vein Moist., 20-25 per cent					
{ Vol., 25-45 per cent Vein Moist., 20-25 per cent							

Numerous systems of classification have been proposed, but none has been received with sufficient unanimity to warrant its general adoption. In the main, they are based on certain ratios which have come to be designated by technical terms as follows:

Fuel Ratio.—A term originally proposed by Johnston, and modified by Frazer is represented by the fixed carbon divided by the volatile matter, $\frac{\text{Fixed C.}}{\text{Vol. M.}}$. Since this ratio is highest in the

¹ FRAZER, PERSIFOR, JR., *Trans. Min. Eng.*, vol. 6, p. 430, 1878.

anthracites and semi-anthracites, and lowest in the lignites, it serves in a general way as an indication of the type of coal as well as its behavior under conditions of combustion.

Carbon-hydrogen Ratio.—This term was proposed by Campbell and represents the percentage of total carbon, divided by the percentage of total hydrogen, $\frac{T.C}{H}$. These factors are obtained by ultimate analysis and are not usually available. Unfortunately also the hydrogen factor* used by Campbell was the total hydrogen of the coal and also of the free moisture which may have happened to be present at the time of analysis. As this constituent is variable and does not govern either the geological or chemical characteristics of the coal it should not be a contributing element in the carbon-hydrogen ratio.

The free moisture as it occurs in the coal vein does have however with comparatively few exceptions a real significance as an accompaniment of the various types of coal. This factor however begins to vary as soon as the coal is broken out of the seam. The topic is mainly one of geological interest and is well set forth in Campbell's later discussion on classification, which also defines the main coal types in terms which will doubtless be universally adopted.¹

The Carbon Ratio.—This represents the volatile carbon (that is, the carbon joined with hydrogen or other elements to admit of its assuming a volatile form) divided by the total carbon content of the coal and this multiplied by 100 gives directly the per cent the volatile carbon is of the total carbon.

The advantage of any ratio, making use of the actual fuel constituents, is the fact that it remains the same whether the moisture and ash are present or absent, thus eliminating some of the most serious variables inherent in many of the proposed schemes of classification.

Classification by Heat Values.—By eliminating the variables, such as moisture, ash and all adventitious material, it is evident that the heat value for the residual substance would be modified by the inherent variations of the pure coal constituents, that is, the carbon, hydrogen and oxygen present. Obviously therefore,

¹ *Professional Paper 100-A*, by M. R. CAMPBELL, 1917.

this leads us to a consideration of the heat values for unit coal as a basis of classification. Such values will be found to give very consistent indications of the type variations.

Derivation of Heat Values for Unit Coal.—It is obvious that if the heat value of the unit coal is constant within narrow limits for a given mine or region we may if such unit values are known, reverse the calculation, making use of any known or assigned values for moisture, ash and sulphur, and so determine by calculation the heat value of the commercial product for that particular mine or region for which the unit coal value is a constant. We shall need to discuss in the first place, therefore, the method of calculating unit coal values.

From our previous discussion of the formula which has been developed to represent the percentage of unit coal, it is readily seen that the expression for deriving the heat value for that substance would be as follows: Using W for water, A for ash, and S for sulphur. For coals with values given on the "as-received" or "wet" basis:

$$\text{B.t.u. of Unit Coal} = \frac{\text{Indicated (Wet) B.t.u.} - 5,000\text{S}}{1.00 - (W + 1.08A + 22/40\text{S})}$$

For coals with values given on the "dry" or moisture-free basis:

$$\text{B.t.u. of Unit Coal} = \frac{\text{Indicated (dry) B.t.u.} - 5,000\text{S}}{1.00 - (1.08A + 22/40\text{S})}$$

The expression 5,000S has been used as indicating the heat due to the combustion of sulphur, for the reason that the value 4,500S as used in Dulong's formula represents the heat of combustion for pure sulphur, while the heat of combustion of sulphur in the form of pyrites, FeS_2 , combines also the heat of formation of iron oxide, Fe_2O_3 . It is the resultant value, therefore, of the several reactions involved that is desired.

According to the direct tests by Somermeier,¹ in the combustion of coal with known weights of iron pyrites, the indicated heat per gram of sulphur so combined is 4,957 cal. In calculating heat values, the correction introduced for the combinations resulting from calorimeter reactions as compared with open-air combustion is 2,042 cal. per gram of pyritic sulphur; hence 4,957 - 2,042 or 2,915 cal. (5,247 B.t.u.) represents the heat due to

¹ *Jour. Am. Chem. Soc.*, vol. 26, p. 566.

burning one gram of sulphur in pyritic form instead of 2,250 cal. (4,050 B.t.u.), the amount which would be credited to sulphur in the free condition. A strict application of these values, therefore, would call for a correction of 5,247S, as representing the heat to be subtracted for the sulphur. This, however, would imply that all of the sulphur is in the pyritic form. Since a certain portion of the sulphur is always present in organic or other form of less heat-producing capacity, it is deemed more nearly correct to use an even factor of 5,000 as representing the heat to be credited to unit amounts of the total sulphur present.

The adaptability of this formula for determining the percentage of the pure coal substance has been fully set forth in Chapter V. The data there given, using the calorific values as evidence of constancy of composition for given areas, may naturally be interpreted in terms of classification or demarcation of types. This point may be graphically represented by reference to Fig. 15.

In this illustration three types of coal are shown with the relative amounts of each constituent indicated by appropriate areas. In that part of the pure coal substance designated as volatile matter the oxygen compounds are shown by the cross-hatched portions. Evidently the extent of these areas, being calculated to the fully oxygenated or "inert" basis, furnish a very pronounced influence upon the calorific value of the pure coal or "Unit" material. This basis of classification is made use of in the discussion and references which follow.

By computing the heat values as derived by this formula for solid fuels throughout the United States, as published by the United States Geological Survey, the Ohio State Survey, and the Illinois Geological Survey, we have in tabular form, giving the extremes for each general fuel type, the following:

TABLE VI.—CLASSIFICATION OF FUEL TYPES BY HEAT VALUES FOR UNIT COAL OR ACTUAL ORGANIC SUBSTANCE

	B. T. U.
Cellulose and wood.....	7,500 to 8,500
Peat.....	7,800 to 11,500
Lignite, brown.....	11,500 to 13,000
Lignite, black, or subbituminous coal.....	13,000 to 14,000
Bituminous coal (mid-continental field).....	14,000 to 15,000
Bituminous coal (eastern field).....	15,000 to 16,000
Semi-anthracite and semi-bituminous.....	15,500 to 16,000
Anthracite.....	15,000 to 15,500

ANALYSIS OF EASTERN COALS

ANALYSIS OF ILLINOIS COALS

ANALYSIS OF LIGNITIC OR BROWN COALS

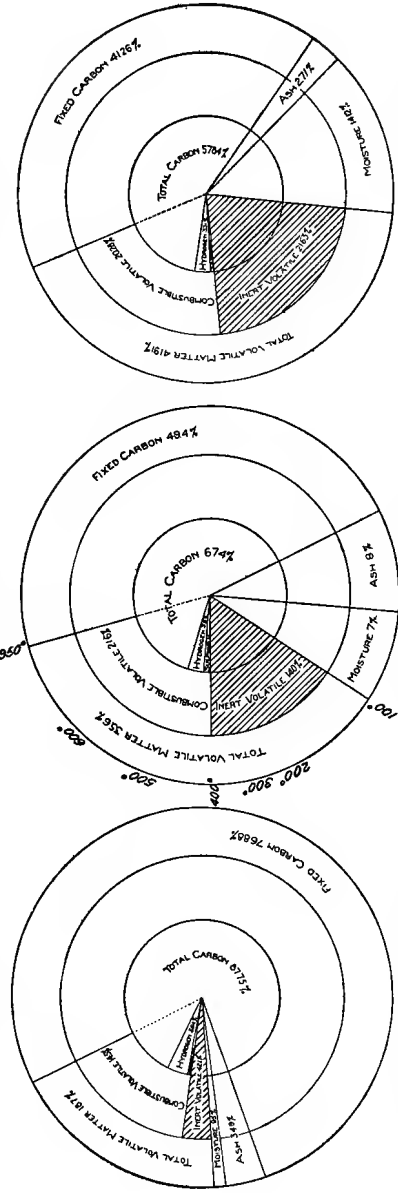

ANALYSIS OF A SEMI-BITUMINOUS COAL (POCAHONTAS) SHOWING CONSTITUENTS IN RELATIVE PROPORTIONS

AVERAGE OF TEN ILLINOIS COALS SHOWING CONSTITUENTS IN RELATIVE PROPORTIONS

ANALYSIS OF A LIGNITIC OR BROWN COAL SHOWING CONSTITUENTS IN RELATIVE PROPORTIONS

Fig. 15.—Graphic representation of the composition of coal.

This study has been carried still further by the Illinois State Geological Survey, and the extremes have been derived for the various seams as worked throughout the coal area of the state.

It is to be recalled that the geologists recognize 16 coal seams for Illinois, counting from the bottom of the coal measures upward. Only seven of these seams are of workable thickness. The numbering 1 to 7 follows the geological order, and not that used in some localities, as at La Salle, Bloomington, etc., where the number of the seam is that which resulted from the order of their development from the surface downward.

Composition of Illinois Coals.—A recent survey carried on by the Illinois State Geological Survey in cooperation with the U. S. Bureau of Mines covered all of the coal producing counties of Illinois and included something over 100 mines. The analytical values for the coals from these mines have been averaged for the various counties and are assembled in Table VII. Where mining operations are carried on from different seams in the same county, the average for the single seam indicated is given separately and not for the county as a whole. Also, for the reason that some of the seams vary widely in character from north to south, the letters N, C, or S are occasionally used to designate the general region from which the samples are taken, namely the north, central, or southern zones. Similarly, since in some rather restricted localities a marked alteration in the seam occurs from east to west, the letters E and W are used as in Perry County, the letter E signifies, for seam No. 6, east and W west of the DuQuoin anticline.

A brief bibliography of discussions upon coal classification is given as follows:

JOHNSON, W. R., *Report to United States Government* on "American Coals," 1844.

URE's "Dictionary," 1845.

FRÄZER, PERSIFOR, JR., *Trans. Min. Eng.*, vol. 6, p. 430, 1878.

WATT'S "Dictionary of Chemistry," vol. 1, p. 1032.

ROGERS, H. D., *The Geology of Pennsylvania*, vol. 2, pp. 988-1006, 1858, U. S. Geol. Surv. *Professional Paper*, No. 48.

TABLE VII.—AVERAGE ANALYTICAL AND HEAT VALUES FOR PRODUCING
COUNTIES IN ILLINOIS
(Compiled from *Bull. No. 29 Ill. State Geol. Survey*)

Table no.	County	Geo-logical seam	Total mois-ture	Vola-tile matter	Fixed carbon	Ash	Sul-phur	Carbon diox-ide	B.t.u.	"Unit coal"
1	Bureau	2N	16.27	38.35	38.00	7.38	2.93	0.89	10,883	
			Dry	45.80	45.39	8.81	3.50	1.40	12,997	14,477
2	Christian	1C	11.31	38.89	40.94	8.86	2.35	0.43	11,602	
			Dry	43.85	46.16	9.99	2.65	0.48	13,081	14,717
3	Clinton	6S	12.62	37.08	40.10	10.20	3.90	0.66	10,796	
			Dry	42.45	45.90	11.67	4.46	0.75	12,355	14,290
4	Franklin	6S	9.04	34.62	47.78	8.56	1.45	0.44	11,837	
			Dry	38.06	52.53	9.41	1.59	0.48	13,013	14,538
5	Fulton	5N	16.16	36.27	37.09	10.48	3.14	1.33	10,363	
			Dry	43.26	44.24	12.50	3.74	1.59	12,361	14,416
6	Gallatin	5S	4.30	35.93	49.08	10.69	3.79	0.24	12,616	
			Dry	37.54	51.29	11.17	3.96	0.25	13,183	15,109
7	Gallatin	6S	7.54	34.96	45.68	11.82	4.34	0.23	11,916	
			Dry	37.81	49.41	12.78	4.70	0.25	12,888	15,136
8	Grundy	2N	17.28	38.48	39.02	5.27	2.33	0.83	11,113	
			Dry	46.49	47.14	6.37	2.82	1.00	13,426	14,496
9	Jackson	2S	9.28	33.98	51.02	5.72	1.29	0.29	12,488	
			Dry	37.46	56.24	6.30	1.42	0.32	13,765	14,818
10	Jackson	6S	8.96	34.44	46.40	10.20	2.65	0.40	11,609	
			Dry	37.83	50.97	11.20	2.91	0.44	12,751	14,608
11	La Salle	2C	15.70	39.54	36.17	8.59	3.48	0.96	10,731	
			Dry	46.91	42.89	10.20	4.12	1.15	12,728	14,444
12	La Salle	5C	14.76	41.33	34.26	9.65	3.38	0.61	10,692	
			Dry	48.49	40.19	11.32	3.97	0.71	12,543	14,397
13	La Salle	7C	13.56	40.87	37.80	7.77	3.68	0.17	11,347	
			Dry	47.28	43.73	8.99	4.26	0.20	13,127	14,685
14	Logan	5C	14.20	37.19	37.44	11.37	3.34	1.42	10,490	
			Dry	43.35	43.40	13.25	3.89	1.66	12,226	14,400
15	McLean	5C	13.32	38.00	36.21	12.27	3.73	1.20	10,580	
			Dry	43.84	41.78	14.38	4.30	1.39	12,206	14,604
16	McLean	2C	11.26	42.21	37.73	8.80	3.03	0.98	11,566	
			Dry	47.57	42.52	9.91	3.41	1.10	13,034	14,714
17	Macon	5C	14.15	36.68	38.83	10.34	3.57	0.52	10,661	
			Dry	42.73	45.23	12.04	4.16	0.60	12,418	14,419
18	Macoupin	6C	13.88	38.20	37.75	10.17	4.31	0.34	10,657	
			Dry	44.36	43.83	11.81	5.00	0.39	12,375	14,349
19	Madison	6S	13.47	38.59	38.03	9.91	4.22	0.42	10,760	
			Dry	44.60	43.95	11.45	4.88	0.49	12,435	14,370
20	Marshall	2N	15.10	39.06	38.68	7.16	2.79	0.48	11,315	
			Dry	46.01	45.56	8.43	3.28	0.56	13,327	14,796
21	Marion	6S	10.79	37.53	40.46	11.22	3.96	0.45	11,069	
			Dry	42.07	45.35	12.58	4.44	0.51	12,408	14,511
22	Menard	5C	17.33	35.88	38.62	8.17	3.44	0.50	10,499	
			Dry	43.40	46.72	9.88	4.16	0.60	12,700	14,478
23	Mercer	1W	15.58	39.17	35.80	9.45	4.69	0.53	10,673	
			Dry	46.40	42.41	11.19	5.55	0.63	12,643	14,546
24	Montgomery	6C	14.15	36.88	39.14	9.83	3.84	0.70	10,642	
			Dry	42.96	45.59	11.45	4.47	0.83	12,396	14,290
25	Moultrie	6C	6.83	39.15	42.32	11.70	4.02	0.57	11,877	
			Dry	42.02	45.42	12.56	4.31	0.61	12,748	14,882
26	Peoria	5C	14.96	36.65	36.99	11.40	3.26	1.50	10,506	
			Dry	43.10	43.49	13.40	3.83	1.77	12,354	14,614
27	Perry	6C	9.92	32.72	46.97	10.39	0.92	0.25	11,335	
			Dry	36.81	52.15	11.53	1.02	0.28	12,583	14,407
28	Perry	6W	11.00	36.75	41.97	10.28	3.36	0.56	11,087	
			Dry	41.29	47.16	11.55	3.78	0.63	12,457	14,359
29	Randolph	6S	11.13	37.28	40.14	11.45	4.24	0.58	10,855	
			Dry	41.95	45.17	12.89	4.77	0.65	12,214	14,351
30	Saline	5S	6.92	35.44	49.06	8.58	3.76	0.39	12,314	
			Dry	38.08	52.70	9.22	4.04	0.42	13,229	14,794
31	Sangamon	5C	14.35	37.30	37.57	10.78	4.16	0.59	10,555	
			Dry	43.55	43.86	12.59	4.86	0.69	12,323	14,415
32	St. Clair	6S	11.25	39.57	38.39	10.79	3.99	0.63	11,028	
			Dry	44.59	43.26	12.15	4.50	0.71	12,426	14,457
33	Tazewell	5C	14.38	37.74	38.23	9.66	3.10	1.20	10,809	
			Dry	44.08	44.65	11.28	3.62	1.40	12,624	14,496
34	Vermilion	6C	14.45	35.88	40.33	9.34	2.55	0.75	10,920	
			Dry	41.94	47.14	10.92	2.98	0.88	12,764	14,575
35	Vermilion	7C	12.99	38.28	38.75	9.98	2.93	0.56	11,143	
			Dry	44.00	44.53	11.47	3.37	0.64	12,807	14,740
36	Williamson	6S	9.31	33.38	48.90	8.41	1.54	0.36	11,913	
			Dry	36.81	53.92	9.27	1.70	0.40	13,136	14,655

PARR, S. W., *Jour. Am. Chem. Soc.*, vol. 28, p. 1425.

CAMPBELL, M. R., *A. I. M. E.*, vol. 36, p. 324.

GROUT, F. F., "Economic Geology," p. 226, 1907.

WHITE, DAVID, *U. S. Geol. Surv. Bull.* No. 382.

CAMPBELL, U. S. Geol. Surv., *Professional Paper* 100-A.

THIESSEN, R., *U. S. Bureau of Mines, Bull.* No. 117.

CHAPTER IX

COAL CONTRACTS¹

Introduction.—Present-day tendencies relating to the purchase of coal under specification are reflected in the following quotations:

When a proper sample of the coal is secured, the chemical analyses and calorimeter determinations for B.t.u. are a better guide to the value of the coal than are one or two boiler tests for the same purpose.²

The purchase of coal under specification is as advantageous as a definite understanding regarding the quality and other features of any other product, or of a building operation or engineering project. The man who buys under specification gets what he pays for and pays for what he gets.³

The heating power expressed in British thermal units per pound is the most direct measure of the value of coal. Contracts made on what is termed the "heat-unit basis" provide therefore that the amount of money paid shall be in direct proportion to the number of heat units delivered. It is evident that the number of heat units varies inversely with the quantity of ash and moisture. That the bidder should be thoroughly familiar with these factors in their application to the coal which he proposes to furnish is self-evident. A thorough understanding of the methods of awarding contracts is essential to the dealer who proposes to enter bids on a competitive basis. Similarly the purchaser must not only be able to formulate his own contracts but also to check up the various bids in a way that will enable him to determine their reasonableness and likelihood of proper fulfillment. Specifications for the purchase of coal have passed through an extended process of development. It may be that

¹ PARR, S. W., Adapted from Ill. State Geol. Surv., *Bull.* 29, 1914.

² "The Purchase of Coal," The Arthur D. Little, Inc., Laboratory of Engineering Chemistry, pp. 10-11, 1909.

³ POPE, G. S., Purchase of coal by the government under specifications: U. S. Geol. Surv., *Bull.* 428, p. 10, 1910.

no one method is even now applicable in all regions or under all conditions. The discussion here presented is based mainly on the practice of the Board of Administration for Illinois in the purchase of coal for the State Institutions. It is closely related also to the procedure employed by the United States under the immediate direction of the Bureau of Mines in the purchase of coal for government use.

Calculation of Commercial Heat Values for Contracting Purposes.—From what has already preceded in the discussion of unit coal values and the reliability of the constants thus developed, it will at once suggest the use of such factors on the part of the coal operator or dealer in formulating a proposal for coal deliveries. A brief resumé and application of this feature will be helpful.

In Table VIII a few illustrative examples are given of unit coal values. Complete tables covering all of the producing counties of the state have recently been published¹ from which these figures have been taken:

TABLE VIII.—AVERAGE HEAT VALUE FOR UNIT COAL IN BRITISH THERMAL UNITS PER POUND

No.	County	Coal bed	Number of samples averaged	Average—B.t.u. "unit coal"
1	Sangamon.....	5	15	14,424
2	Sangamon.....	6	5	14,340
3	Macoupin.....	6	6	14,310
4	Madison.....	6	18	14,350
5	Vermilion.....	6	19	14,597
6	Vermilion.....	7	9	14,730
7	Williamson.....	6	5	14,750

The use which can be made of these "unit" values such as are shown in this table may be readily understood when it is remembered that each number represents material which is 100 per cent pure and that for each per cent of inert matter present, such as water and ash, there is a corresponding decrease in the number of heat units present. That is to say, if a coal has 20 per cent water and ash, then 80 per cent of the "unit" value will

¹ PARR, S. W., Purchase and sale of Illinois coals on specification: Ill. State Geol. Surv., *Bull.* 29, 1914.

represent the heat units present per pound of coal as delivered. Indeed, it is possible by taking account of certain refinements already referred to such as correction factors for sulphur and hydration of the shaly constituents, to make a calculation which will be of quite sufficient accuracy for basing bids and entering into contracts involving a guarantee as to heat values. The method of calculation is exceedingly simple and is based on the following expression:

Let A = weight of ash per pound of coal.

Let S = weight of sulphur per pound of coal.

Then

“Dry” B.t.u. = “Unit” B.t.u. $\times [1.00 - (1.08A + 0.55S)] + 5,000S$.

To illustrate, take the “unit” value for coal from Vermilion County, Sample No. 6 in Table VIII. Suppose we wish to know what heat value can be guaranteed on deliveries from a mine of this group on the basis that we can furnish material averaging as the “dry coal,” 12 per cent ash, and 3 per cent sulphur, we will have our total non-combustible material corrected by the above formula as follows:

1.08A .	12.96
0.55S .	<u>1.65</u>
Total	14.61

$$100\% - 14.61\% = 85.39\%$$

$$14,730 \times 85.39\% = 12,578$$

In this calculation the sulphur has been neglected. It has a small heat value equal to 5,000 times the weight of sulphur present or 50 times the percentage number, thus:

$50 \times 3 = 150$ units to be added to the above value, or

$$\begin{array}{r} 12,578 \\ 150 \\ \hline 12,728 \text{ B.t.u.} \end{array}$$

Deliveries from this mine, therefore, having ash, and sulphur as indicated above can be depended upon as carrying 12,728 heat units per pound of “dry” coal, and this factor should be accurate within 100 units in 12,000 or less than a variation of 1 per cent from values as they would be determined by direct reading from

an instrument.¹ Any other set of values for ash and sulphur would similarly admit of ready calculation and should be used as a basis for calculations involving guarantees of deliveries on a heat-unit basis. If the heat units on the "wet" coal basis are desired assuming, for example, a moisture factor of 15 per cent, the above value as derived for "dry" coal should be multiplied by 0.85, that is, $12,728 \text{ B.t.u.} \times 0.85 = 10,818 \text{ B.t.u.}$ per pound of the "wet" coal, assuming a moisture factor of 15 per cent as indicated.

Significance of Heat Values.—The cost of a given lot of coal must be based upon the weight of the material. The sample taken should represent the coal "as delivered," and, as already emphasized, moisture changes in the sample are to be carefully guarded against. Variations in quality are taken into account by varying the price per ton directly in proportion to the number of heat units delivered. In the award of contracts and in computations for payment, therefore, the calculations are based upon the heat units per pound in the coal "as delivered."

Concerning the Ash.—If there were no other effect produced by ash variations than a corresponding variation in the heat units then no further account would be taken of that constituent since it would be taken care of in the calculations involving the heat units. However, on account of the expense in handling, and because of a lowering of efficiency resulting from excessive ash, an additional modification in price is made for this constituent. For greater convenience where comparisons are involved and to eliminate the moisture variable, it is found preferable to refer the ash values to the "dry-coal" basis. This involves the use of a double standard of reference; the heat units are referred to the "wet" or "as-received" basis and the ash is referred to the "dry" or "moisture-free" basis.

The usual methods of applying the various conditions involved are given as follows:

Bids and Awards.—1. Bidders are required to specify their coal offered in terms of British thermal units "as-received," but ash is specified on the "dry-coal" basis. These values become the standards for the coal of the successful bidder.

2. In order to compare bids, all proposals are adjusted to a common basis. The method used is to merge all three variables

¹ Compare with values found for Sample No. 35, Table VII.

—ash, calorific value, and the price bid per ton—into one figure. This figure will be the cost in cents of 1,000,000 B.t.u. and is derived as follows:

(a) All bids are adjusted to the same ash percentage by selecting as the standard for comparison the proposal that offers coal containing the highest percentage of ash. Each 1 per cent of ash content below that of this standard will be assumed to have a positive value of 2 cents per ton, and accordingly the price will be decreased 2 cents, which is approximately the amount of premium allowed under the contract for 1 per cent less ash than the standard established in the contract. Fractions of a per cent will be given proportional values.¹ The adjusted bids will be figured to the nearest tenth of a cent.

(b) On the basis of the adjusted price, allowance will then be made for the varying heat values by computing the cost of 1,000,000 B.t.u. for each coal offered. This determination will be made by multiplying the guaranteed B.t.u. per pound by 2,000 and dividing the product by 1,000,000. This factor gives the guaranteed number of million units per ton of delivered coal. Dividing the adjusted price as found under (a) by this factor gives the cost per million heat units.

A convenient form for tabulating bids to indicate the various factors entering into the final computation of cost is shown below.

TABLE IX.—CONVENIENT FORM FOR TABULATING BIDS

No.	Coal offered	Guarantees		Price per ton 2,000 lb.		Computed cost in cents per 1,000,000 B.t.u. (b)
		Ash in "dry coal," per cent	B.t.u. "as received"	As bid	As ad- justed for ash (a)	
A	Vermilion county screen- ings.....	17	10,300	1.50	1.50	7.3
B	Sangamon county screen- ings.....	16	10,400	1.35	1.33	6.4
C	Williamson county screenings.....	14	12,500	2.00	1.94	7.8

¹ The actual amount of premium or penalty will vary slightly with the price as will be seen under the paragraph on "Price and Payment." However the use of a common factor applied to all bids will place the various estimates in their proper relative positions.

Price and Payment.—Payment for coal specified in the proposal will be made upon the basis of the price therein named, which has been corrected for variations in heating value and ash from the standard specified in the contract, as follows:

(a) Considering the guaranteed heat units on the "as-received" basis, no adjustment in price is made for variations of 2 per cent or less in the guaranteed standard. When the variation in heat units exceeds 2 per cent of the guaranteed standard, the adjustment in price will be a proportional one and is determined by the following formula:

$$\frac{\text{B.t.u., delivered}}{\text{B.t.u., guaranteed}} \times \text{bid price} = \text{price corrected for B.t.u.}$$

The correction is figured to the nearest tenth of a cent.

(b) Considering the guaranteed ash percentage, a tolerance of 2 per cent above or below the guaranteed percentage of ash on the "dry-coal" basis is recognized. For variations greater than 2 per cent above or below the standard guaranteed, the adjustment in price shall be determined as follows:

One-half of the discrepancy in ash percentages is multiplied by the bid price and the result is added to or subtracted from the price as adjusted for B.t.u. The ash adjustment is figured to the nearest tenth of a cent.

As an example of the method of determining the deduction in cents per ton of coal containing ash exceeding the standard by more than 2 per cent, suppose coal delivered on a contract guaranteeing 10 per cent has on the "dry-coal" basis shows by analysis to have 14.50 per cent, the deduction according to this method would be $\frac{1}{2} (4.50) \times \text{price corrected for B.t.u.}$ ¹

The Formulation of Proposals.—The coal operator should know what guarantee he can maintain in making up his bid. The purchaser should be able to determine the likelihood of the operator being able to fulfill his guarantee without excessive penalties. Where unit coal values are known for a particular mine or district this information is a simple matter of calculation and has already been explained on page 60. Table VII of average unit values for the producing counties will furnish the initial data.

¹ Methods of sampling and specifications for the government: U. S. Bureau of Mines, *Bull.* 116, p. 51, 1916.

CHAPTER X

COMBUSTION OF COAL

General Principles.—The difficulties attending the complete combustion of bituminous coal are directly related to the volatile matter present. The showing of large volumes of smoke, therefore, is a sure sign of serious loss of the fuel constituents. The underlying principles furnish a sufficient explanation for the losses which accompany heavy smoke. A brief enumeration, therefore, is here given:

(a) At temperatures below 400°C. about one-half of the total volatile matter of bituminous coal is discharged.

(b) The first distillates at these lower temperatures are composed of water vapor, oxides of carbon, some hydrogen and methane, but chiefly the so-called heavy hydrocarbons, ethylene, propylene, benzene, etc., including also some compounds which are light oils and tars at ordinary temperature.

(c) Under the most favorable conditions it is difficult to burn these heavier compounds without producing a smoky flame, a prerequisite being a much larger mixture of air than that required for the distillates which come off at the higher temperatures, mainly methane (CH_4) and hydrogen.

(d) A high percentage of moisture, which is also discharged simultaneously with the heavy hydrocarbons, accentuates the difficulty by sudden expansion into steam and consequent displacement of air, as well as by lowering the temperature of the combustion chamber while the process of vaporization is proceeding.

From this enumeration, it is evident that to discharge these first distillates into a relatively cooler zone emphasizes the unfavorable conditions for combustion and results also in a condensation of some of the compounds, all of which is made evident by the appearance of dense volumes of smoke. This is always the result

with house-heating appliances and is more or less evident with all steam-generating devices which are fired intermittently.

The mechanical or physical features essential to smokeless combustion are now well understood as the result of the elaborate experiments carried on by various investigators.¹ The two fundamental elements involved are: First, a continuous accession of fuel by some system of automatic stoking; and, second, the discharge of the volatile products into a highly heated combustion zone for accomplishing both the necessary admixture of air and the completion of the oxidation processes before coming in contact with the relatively cool surfaces of the boiler tubes.

Oxygen Supply.—One pound of pure carbon requires theoretically $\frac{8}{12}$ or $2\frac{2}{3}$ lb. of oxygen for complete combustion. Since 23 per cent of the air by weight is oxygen, 1 lb. of carbon requires 11.58 lb. of air. For any reasonable degree of efficiency under the conditions prevailing in the average combustion device, this amount of air must be increased by at least 50 per cent. Very much depends, however, upon the distribution of air allowance. The volatile hydrocarbons which are discharged from the fuel bed are at a double disadvantage. Not only are they particular in the matter of temperature at which they will maintain combustion and the ready accessibility of their oxygen supply, but they are further handicapped by the fact that this oxygen supply is haphazard in amount and not easily adjusted to meet the varying requirements of the volatile matter. This is the more readily appreciated when it is remembered that any combustion processes taking place in the combustion chamber above the fuel bed must come from openings above the grates, since practically no air with free or unused oxygen can come through the fuel bed.² This involves numerous considerations, perhaps more mechanical than chemical, such as distribution of openings, size of combustion space, completeness of mixing and pressure of gases within the furnace or "drafts." These considerations have a vital bearing, especially upon a number of topics relating to good efficiencies in combustion, only a few of which can be referred to here.

¹ BEMENT, A., *Jour. Western Soc. Eng.*, vol. 13, 2, pp. 209-282, April, 1908.

BRECKENRIDGE, L. P., Univ. of Ill. Eng. Exp. Sta. *Bull.* No. 15, 1907.

² U. S. Bureau of Mines, *Bull.* 135, 1917.

Smoke.—It is evident from the preceding discussion that smoke reduction depends upon (a) admission of air above the fuel bed, (b) thorough mixing, and (c) the maintenance of a temperature above the ignition point of the gases and vapors involved. Failure on the part of any one of these three conditions will result in smoke where bituminous coal is being burned. In house-heating appliances only the first condition, (a), can be employed to any practical degree and this especially under the conditions of intermittent firing is for all practical purposes, substantially lacking. Hence, as a general statement, it may be said that all house-heating appliances produce smoke. In the

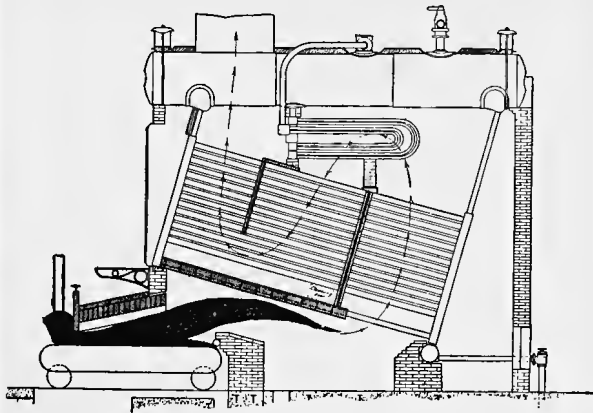

FIG. 16.—Stoker boiler, showing tile baffling.

aggregate this is more than that produced by factories and small establishments combined.

In the case of large installations the conditions under (a) and (b) are the most readily provided through the use of stokers which avoid the intermittent conditions which accompany hand firing. A steady accession of fuel results in a uniform discharge of volatile combustible, which can be met with reasonable accuracy by a definite admission of air above the fuel. Varying loads and varying draft pressures however complicate the problem.

The most difficult condition of all to meet is that under (c) or (b) and (c) combined. The ignition temperature of the more common gases discharged into the combustion chamber such as

methane, for example, is from 650 to 750°C. or a mean of 700°C. (1,300°F.) and for hydrogen it has an average ignition temperature of 585°C. or 1,085°F.¹

The temperature of the flues in a water tube boiler doubtless

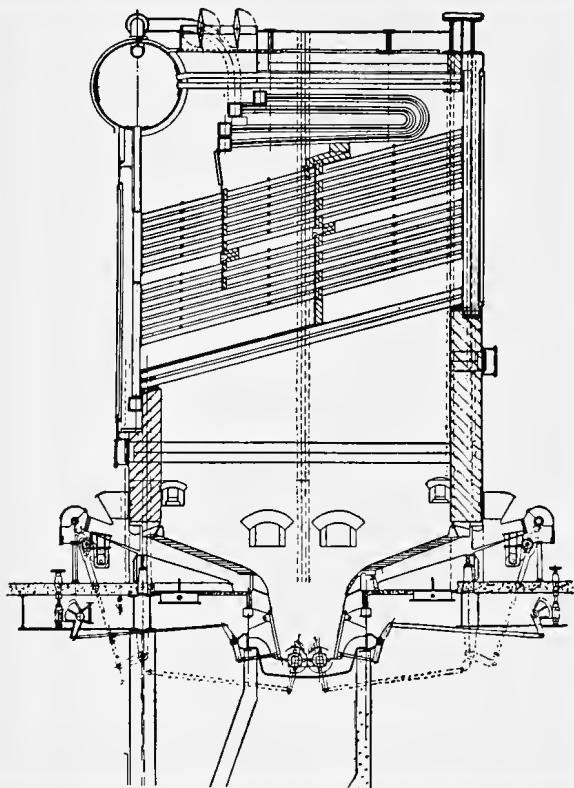

FIG. 17.—Sectional view of stoker and boiler.

never exceeds 200°C., (425°F.) at 300-lb. gage pressure.² Among the more common methods for securing the necessary temperatures are those which provide a longer combustion chamber. This may be secured horizontally, as in the tile baffling of the

¹ DIXON and COWARD, *Jour. Chem. Soc.*, vol. 95, p. 519, 1909.

² See MARKS and DAVIS, "Steam Tables," Longmans, Green Co.

lower flues, Fig. 16, or by elevating the boiler above the fuel bed as shown in Fig. 17, where the extreme height between the fire and flues may average as much as 15 ft. A good illustration is shown in Fig. 18 of the effect of cooling the gases discharged from the fuel bed below the temperature of ignition before combustion is complete.

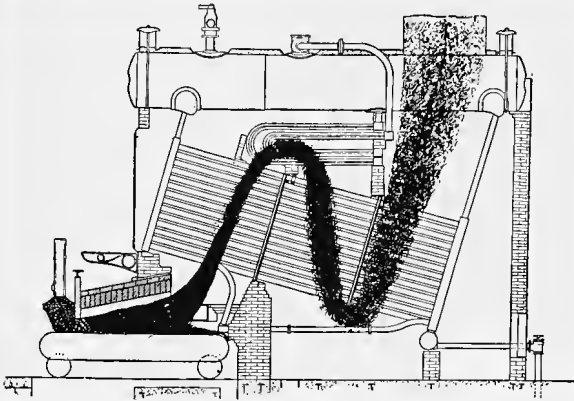

FIG. 18.—Stoker and boiler, showing effect of cooling the gases below their ignition temperatures.

Clinker Formation.—The worst enemy of efficiency in the burning of bituminous coal is any condition of fusion or cementation of the constituents of the fuel bed in such a manner as to impede or block off the passage of air and products of combustion through the mass. The organic matter of some coals has a tendency to fuse readily or “cake,” but this property, to the extent of interfering with the free burning of coals of the Illinois type, is not of a serious nature. A much more difficult problem resides in the tendency of these coals to clinker. Clinker, in the ordinary sense, is the fusion of the inorganic or ash constituents of the coal into masses that interfere with the free access of air. Under normal conditions, from 10 to 25 per cent of the total combustible is discharged into the combustion chamber for burning above the fuel bed. The formation of clinker tends to greatly increase this ratio. The shortage of oxygen also promotes the formation of carbon monoxide and

increases the amount of unburned material passing out with the ash. Moreover, the formation of clinker tends to produce more clinker, for reasons that will readily appear. Coals with a high percentage of pyritic iron FeS_2 have a readily melting constituent in that material. The melting point of FeS_2 is only $1,171^\circ\text{C}$., and even though it decomposes with heat, the resulting compound, FeS melts at about the same temperature $1,197^\circ\text{C}$. The latter compound is quite stable so far as dissociation is concerned, and if nothing occurs to change its composition, it may, if present in considerable quantity, flow down upon or through the grates, having a consistency something like molasses. If the grates become covered with such material, the cooling effect of the air is lost and the grates quickly burn out.

If, on the other hand, the conditions of combustion are kept active so that all of the sulphur is burnt and the iron oxidized to Fe_2O_3 , the fusing point of the latter is $1,548^\circ\text{C}$. and that condition of complete oxidation, if accomplished, practically eliminates the possibility of clinker formation. The accomplishing of this state of complete oxidation involves perhaps more physical conditions than otherwise. Lump coal or sized egg or nut will retain open passage-ways and thus promote oxidation. Slack or screenings or mixed smaller sizes will impede the free access of air. Such coals in house heaters will be very prolific of clinkers, Most mechanical stokers, especially of the under-feed type, tend to keep the fuel mass broken up so that the air has access. In locomotives and fuel beds of unusual width or depth where excessive draft is essential, the carrying of smaller particles of the low fusing constituents by means of the strong draft currents results in "honey-combing" of flue sheets or the spaces between water tubes to such an extent that the passage-ways are seriously reduced or cut off altogether. The most obvious remedy is to increase the air supply to the fuel bed or maintain conditions which will result in more positive oxidizing conditions whereby the resulting ash shall not have an admixture of iron in the form of FeS .¹

Fusibility of Ash.—Much importance is being placed at the present time on the fusibility of ash and specifications covering

¹ PARR, S. W., Honeycomb and clinker formation in locomotives: *Proc. International Ry. Fuel Assn.*, 1914.

the methods for that determination have been adopted.¹ There may be very little relation between the fusibility of the ash as made ready for such a test and the same ash under adverse conditions of combustion where insufficient air and a strongly reducing environment is maintained with a coal of high pyritic content.

The Wetting of Coal.—From the previous discussion as to the cause of clinker formation a sufficient reason is afforded for the practice of wetting down the coals before firing the same under the boiler. The larger use of screenings with the mechanical stokers now in vogue and the higher percentage of iron pyrites in such fuel of the smaller sizes² makes a brief reference to this practice of coal wetting desirable.

The FeS_2 of coal when it reaches the combustion zone of the fuel bed readily changes to FeS . In this condition it may be decomposed by steam. Some of the reactions involved are shown by the equation:

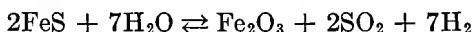

Verification of some of these conditions is afforded when a stream of water is turned on a red hot clinker, the odor of SO_2 being very marked. Similarly, without being able to assign any reason for it, a fireman will maintain that a pool of water retained under the grates and from which the steam rises into the fuel bed will promote a better combustion of the coal. The natural argument would seem to be against the wetting of coal. The latent heat of vaporization of the added water is lost, and the dissociation of the water into hydrogen and oxygen requires as much heat as is produced by their recombination in the combustion chamber. However, the practical result of an open fire bed and a reduction of the clinkering effect decidedly outweighs the theoretical considerations against the wetting down of the coal.

Another consideration from the chemical standpoint would be

¹ FIELDNER, A. C., Tentative method for determining the fusibility of ash: Am. Soc. for Testing Mat., 1920.

² POWELL and PARR, Forms of sulphur in coal: Univ. of Ill. Eng. Exp. Sta., Bull. 111.

YANCEY and FRASER, Distribution of the forms of sulphur in the coal bed: Jour. Ind. and Eng. Chem., pp. 13-35, 1921.

as follows: Water vapor passing through or coming in contact with an incandescent fuel bed would form water gas to a very considerable extent. The gases, H_2 and CO , upon recombining would regenerate only the heat lost in their formation, but their ignition temperatures would permit of a continuation of the combustion process within the relatively cooler zones of the system, as for example in the flue spaces. The heat thus developed would promote the further burning of those hydrocarbons which require a high temperature for their complete combustion, such as marsh gas, etc. Under certain circumstances, therefore, where the conditions approximate those above outlined, it is entirely possible that the wetting of coal may result in an actual increase of efficiency.

Other considerations might be referred to of a more physical type. In the case of finely divided material the water bonding effect may tend to hold the particles in place until the heat reaches the coking or caking stage with the result that less solid fuel is drawn through the combustion chamber into the stack without burning.

Whether these explanations adequately cover the case or not, the fact remains that with the finer sizes of Illinois coals the every-day experience in the boiler room is decidedly in favor of the wetting-down process.

CHAPTER XI

STORAGE, WEATHERING, AND SPONTANEOUS COMBUSTION

Deterioration.—Coal is subject to deterioration from the time of breaking out at the mine until used. These losses, however, are relatively small. A sudden drop occurs in the first week or two, due no doubt to the liberation of certain of the hydrocarbons. Subsequent losses are more largely due to the adsorption of oxygen and the formation of humic compounds which are part of the subsequent coal texture. The cut herewith shown, Fig. 19, is typical and illustrates the kind and amount of losses over the space of one year's storage.¹

Perhaps even more serious than the loss by weathering is the disintegration or slaking which takes place, whereby the coal is reduced in size. It is thus rendered more difficult to maintain a proper circulation of air through the fuel bed. The matter of weathering is discussed in detail in *Bulletin* 38 of the Illinois Engineering Experiment Station.

Spontaneous Combustion.—All coals of the bituminous type are subject to spontaneous combustion. A detailed study of the causes has been made in *Bulletin* 46 of the Illinois Engineering Experiment Station.² Briefly summarized, they are as follows:

1. The oxidation of coal is continuous over a wide range of time and conditions, and begins with the freshly mined coal at ordinary temperatures. A number of oxidation processes are involved which are more or less distinct in character, some being relatively slow and moderate in form, while others are rapid and vigorous in their action.

¹ PARR and WHEELER, The weathering of coal: Univ. of Ill. Eng. Exp. Sta., *Bull.* 38.

PARR, S. W., Effect of storage upon the properties of coal: Univ. of Ill. Eng. Exp. Sta., *Bull.* 97.

² PARR, S. W. and KRESSMANN, F. W., The spontaneous combustion of coal: Univ. of Ill. Eng. Exp. Sta., *Bull.* 46.

2. In general, we may say that for a given coal a point exists as indicated by the temperature, below which oxidation is not ultimately destructive and its continuance is dependent upon certain accessory conditions which, if withdrawn, the oxidation

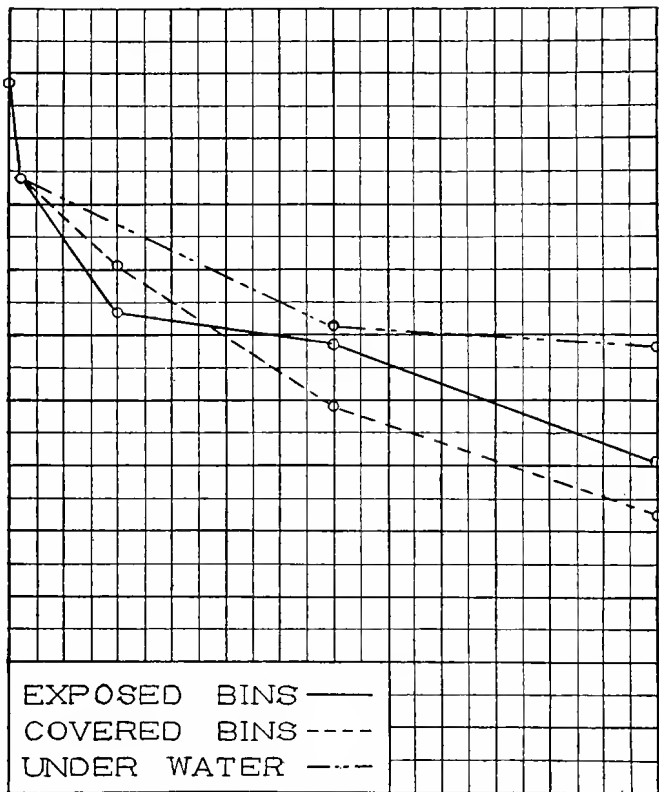

FIG. 19.—Vermilion County, Illinois, screenings showing the loss in heat value for the first two weeks, and for each month following throughout the year.

ceases. On the other hand, above this critical point, which is best indicated by temperatures, oxidation is ultimately destructive and is characterized by the fact that it does not depend for its continuance upon external conditions, but is self-propelling or autogenous.

3. The point of autogenous oxidation, while varying for different conditions, may be indicated by temperatures of the mass ranging from 200 to 275°C., depending to a great extent upon the fineness of division. The phenomenon of fire or actual kindling does not occur until a much higher temperature is reached, usually beyond 350°C.

4. The temperature at which autogenous oxidation begins is the sum of numerous temperature components, each one of which, either because of its own contribution to the total heat quantity or because of its function as a booster for chemical activities, must be looked upon as a dangerous factor tending directly to the ultimate result of active combustion throughout the mass. An enumeration of the more important elements which contribute towards this end are the following:

(a) *External Sources of Heat.*—Oxidation, especially of the lower or moderate form, is greatly accelerated and in certain phases directly dependent upon an increase of temperature. What may be termed external or physical sources of heat, and thus presumably avoidable, are suggested by the following:

1. Contact of the mass with steam pipes, hot walls or floors under which are placed heat conduits of any sort.
2. The heat of impact or pressure due to the method of unloading or to the depth of piling.
3. Climatic or seasonal temperature at the time of storage.
4. The direct absorption of heat from the sun or from reflecting surfaces.

(b) *Fineness of Division.*—Coal in a fine state of division presents a very much larger surface and brings a much larger quantity of reacting substances in contact with oxygen than when in solid masses. Under these conditions, with a condensation or accumulation of relatively large amounts of oxygen immediately surrounding or in contact with the particles of carbonaceous matter, the circumstances are exceedingly favorable for rapid oxidation upon the arrival of the mass to a suitable temperature. But, more especially does this fineness of division facilitate the initial form of oxidation described under (c) below.

(c) *Easily Oxidizable Compounds.*—An initial stage of oxidation exists in bituminous coals which does not result in the formation of carbon oxide. There are present in coals of this type

unsaturated compounds which have a marked avidity for oxygen at ordinary temperatures, the products being humic acid or other fixed constituents of the coal texture. Coals vary widely in this matter and it has been proposed by some to regard this property as an index of the liability to spontaneous combustion. It is, however, very largely dependent upon the freshness of the coal and upon the fineness of division (see, under (b) above). The colloidal character of coal gives it peculiar properties as an adsorptive medium, especially for oxygen. The adsorptive process itself generates a small increment of heat and the greater the adsorption, as in case of fine coal, the greater the amount of such heat. Moreover the adsorption of oxygen is greatly accelerated as the temperature rises, so that the difficulty is cumulative. One peculiarity of the process is that the oxygen thus adsorbed is so tenaciously held by the coal that with the rise in temperature it is not discharged as oxygen, but in the main is retained until actual chemical union is brought about resulting in the formation of H_2O and CO_2 with the natural accompaniment of heat (see also discussion under (f)).

(d) *Iron Pyrites*.—The presence of sulphur in the form of iron pyrites is a positive source of heat due to the reaction between sulphur and oxygen. Here again rapidity of oxidation is directly dependent upon fineness of division. Since coals of the Mid-Continental field especially have a much higher earthy or ash content in the fine material, and since iron pyrites is a large component of this substance, it follows that the presence of dust or duff in all coals of the Illinois type is a positive source of danger. Since coals of the Illinois or Mid-Continental field have in the larger number of cases iron pyrites averaging over 5 per cent or as sulphur above 2.5 per cent, the heat increment from the oxidation of only one-fifth of this material is sufficient to raise the temperature of the mass approximately 70° , assuming that there is no loss by radiation. Under usual conditions, and especially considering the greatly accelerated rate of chemical activity accompanying a rise of temperature, this oxidation may proceed with such rapidity that the heating up of the mass will be but little affected by the loss of heat due to radiation, except in relatively shallow piles. Coals of low sulphur content or such as do not have sulphur greatly in excess of, say 1.5 per cent are

popularly supposed to be immune from heating, but no method of selection or hand-picking at the mine can eliminate all of the iron pyrites. Lumps of coal, to all outward appearance of good texture, may have nodules or detached bands of iron pyrites. These become centers of activity and with the addition of moisture such coal will have many scattered spots where heating begins. If fine coal is mixed in with the coarse, the difficulty is accentuated. Doubtless a complete separation of fine and lump material in such cases would lessen the danger.

(e) *Moisture*.—Moisture, while essential to pyritic oxidation, is given separate mention because its importance is apt to be underestimated. Any coal with pyritic conditions as above mentioned will be facilitated in that action by moisture. It is to be noted in this connection that the normal water content or vein moisture of coals in this central region is rarely below 10 per cent and ranges usually from 12 per cent to 15 per cent. The presence of such water must be borne in mind in considering the likelihood of chemical activity on the part of the pyrites present.

(f) *The Oxidation of Carbon and Hydrogen*.—A third stage of oxidation of the carbonaceous material exists by reason of the property of certain of the hydrocarbon compounds of coal to oxidize with the formation of CO_2 and H_2O at temperatures in excess of 120 to 140°C. Though this type of oxidation does not take place appreciably at ordinary temperatures, it must be looked upon as an exceedingly dangerous stage in the process of oxidation, owing to the very much higher quantity of heat which is discharged by the oxidation of carbon and hydrogen; so that the temperature of autogenous action, though ordinarily occurring at a higher point by 100° or more, may be quickly attained as a result of this form of oxidation. Any initial heat increments, therefore, which threaten to bring the chemical activities along to the point where the oxidation processes invade the carbonaceous material in this manner must be looked upon as dangerous. For example, any of the initial or contributory processes which result in raising the temperature of the mass 50° above the ordinary temperature would, in all probability, have enough material of the sort involved in such action to continue the activity until another 50° had been added, which would

thereby attain to the condition wherein this third stage of oxidation would begin.

(g) *Autogenous Oxidation*.—The fourth stage of oxidation may be indicated as occurring at temperatures above 200 to 275°C. and differs from the previous stages in that the action is autogenous and not dependent upon other sources of heat to keep up the reacting temperature. Activity in this stage is further accelerated by the fact that above 300° the decomposition of the coal begins which is exothermic in character, thereby contributing somewhat to a further increase in temperature. The ignition temperature is reached at a point still further along, usually in excess of 300 to 400°C.

Storage Methods.—The above formulation of various stages and types of oxidation clearly indicates the principles which must be observed in any attempt at the prevention of spontaneous combustion. The following enumeration, therefore, of preventive or precautionary measures is to be considered as suggestive rather than complete in character:

First.—The avoidance of external sources of heat which may in any way contribute toward increasing the temperature of the mass is a first and prime essential.

Second.—There must be an elimination of coal dust or finely divided material. This will reduce to a minimum the initial oxidation processes of both the carbonaceous matter and the iron pyrites. These lower forms of oxidation are to be looked upon as boosters, without which it would be impossible for the more lively and destructive activities to become operative.

Third.—Dryness in storage and a continuation of the dry state, together with an absence of finely divided material, would practically eliminate the oxidation of the iron pyrites. The drenching down with water of heating piles, where the sulphur content is high and uniformly distributed, accentuates the difficulty. Where pyritic activity is localized in spots or is so small in amount as to reach a possible exhaustion, the drenching with water may check the heating or prolong the action so that oxidation of the carbonaceous matter does not get under way to a serious extent. In such cases, however, there is no ultimate safety except in the removal of the heated zones.

Fourth.—The submerging of coal, it is very evident, will elimi-

nate all of the elements which contribute towards the initial temperatures. As to its industrial practicability it can best be determined by actual experience.

Fifth.—The storing of coal should be made in sized lumps only. The air spaces are greater of course in any given size than in a mixture of sizes. Such masses provide a relatively free circulation of air whereby the small initial increments of heat are carried off. However, if spots occur in the mass where fine material has been dumped or formed, this same free circulation of air makes such spots especially dangerous.

Sixth.—Coal may be stored in the finely divided condition, provided it is all fine material with no lumps to open up air passages, and provided further that the material as stored is packed uniformly so as to exclude the admission of air.

It is as dangerous to store fine coal with accessory conditions admitting free access of air, such as lumps or passage-ways held open by posts, supports or structural features of retaining walls, as it is to store lump coal with occasional zones where fine material is allowed to form or where an occasional load of mixed fine and coarse stuff is dropped, or where coarse material, properly sized, is stored against or in contact with fine material in storage. The line of contact will be a certain source of fire.¹

¹ See the Storage of bituminous coal, by H. H. STOEK, Univ. of Ill. Eng. Exp. Sta., *Circular* 6, 1918. Also, the Effect of storage upon the properties of coal, by S. W. PARR, Univ. of Ill. Eng. Exp. Sta., *Bull.* 97.

CHAPTER XII

COKE

General Statement.—Under the second division of solid fuels is included coke and other forms of artificially prepared material, such as charcoal, briquettes, etc. Coke occupies by far the largest place in the list of manufactured fuels. The yearly production approximates 52,000,000 tons. Of this a small portion is used in domestic appliances. For such purposes the low content of volatile matter, not over 2 per cent, requires some care in the matter of draft regulation, low fires are not as easily managed as where more active conditions are maintained. As one element in the attempt to overcome this difficulty “low temperature” carbonization is now receiving much attention. The coke product of such treatment should have an average of 10 or 12 per cent volatile, though this constituent can probably be varied between 5 and 15 per cent. This would greatly simplify the matter of combustion control in household use.

It is not intended here to go into a detailed discussion of the low-temperature process. The topic should not be passed, however, without brief reference. If ever such a process becomes practicable, it will doubtless profoundly affect the entire coke, gas, and tar industries. At the present time no such process has been developed to the point of a commercial success in this country. The experimental work being carried on for many years at the University of Illinois has had as a fundamental object the development of a theory of carbonization applicable to high-oxygen coals of the Illinois type. The present status of this and some of the more advanced developments are best referred to in current technical literature.¹

Metallurgical Coke.—By far the chief use of coke is in the blast furnace for the reduction of iron ore. From 1,600 to 1,800 lb. or slightly less than 1 ton of coke is required for the production

¹ Symposium on fuels, *Jour. Ind. and Eng. Chem.*, January, 1921.

of 1 ton of pig iron. Approximately 40,000,000 tons of coke are used annually in the United States in the manufacture of pig iron. Incidentally, it should be noted that after doing the work of reduction on the iron ore, the discharged gases have a positive value as a fuel, hence the blast furnace may be looked upon as an appliance for the manufacture of producer gas on an enormous scale. Approximately 5 tons of gas pass out of the blast furnace for each ton of pig iron produced, and from 25 to 30 per cent of this is carbon monoxide. It has been estimated¹ that a net potential value of approximately 850 hp. might be available for every ton of iron produced per hour. At the moderate estimate of 2,000 tons of iron per hour in this country there would be represented over 1,500,000 hp. available per hour as a by-product of the blast furnaces alone. The largest power plant in the world operating on blast-furnace gas led directly after scrubbing to high-compression engines, is located at Gary, Ind., where the gas from eight blast furnaces supplies 39 gas engines developing 142,875 hp. per hour. In 1913 the total installations of blast furnaces in the United States represented a potential generation of 339,280 hp. per hour, or over 11,000,000,000 hp. per year.

Sampling and Analysis.—Methods for the sampling and analysis of coke are substantially the same as for coal. See the reports of the special committee of the American Society for Testing Materials.² One or two peculiarities of the material should be especially noted by the chemist.

Pulverizing of Coke.—In the preparation of coke for analysis fine grinding is not so easily accomplished as in the case of raw coal. Grinding apparatus using iron surfaces may give up appreciable amounts of metallic iron to the sample. The final reduction is best made in an agate mortar.

Volatile Matter.—When coke, especially in the finely divided state, is cooled down from a red heat, it has marked absorption properties, especially for oxygen. Upon re-heating, this oxygen combines with the carbon or absorbed hydrogen to an appreciable extent and is given off as H₂O and CO₂, thus augmenting the apparent amount of volatile matter. For this reason repeated

¹ STILLMAN'S "Chemical Engineering," 4th ed., p. 267.

² Committee Reports, Tentative Standards: *Proc.*, 19th Annual Meeting, Am. Soc. for Testing Mat., part I, p. 551, 1916.

volatile matter determinations on the same sample seem to give an indefinite amount of volatile matter.

Sulphur.—Sulphur in coke, like oxygen and hydrogen and doubtless also nitrogen, is held in a surface condensation condition, and not as a sulphide of carbon, in the ordinary sense. The original organic sulphur compounds have been decomposed, also the inorganic sulphur in the form of iron pyrites has discharged practically all of its sulphur. A small amount only may remain as pyrrhotite or magnetic sulphide of iron. The sulphur thus discharged, mainly in the form of H_2S readily undergoes surface absorption or adsorption by the coke at low-red heat, and in this form is stable even at $1,000^\circ C$. From this form, however it is easily discharged under oxidizing and alkaline conditions either by fusion in sodium peroxide or by the usual Eschka method, for determination as SO_3 .

CHAPTER XIII

Wood

Introduction.—Under certain conditions and in certain regions wood and wood waste have a fuel value which may attain to technical importance. One or two points of interest should be discussed in this connection.

No attempt has been made to apply the same descriptive terms to wood as are applied to coal. For example, "dry" wood has no specific meaning, such as "moisture-free" or "oven-dry" material. It probably would be understood to mean simply well seasoned wood as opposed to that which was green or unseasoned.

Heat Values.—Another uncertainty concerns the heat value which should be assigned to wood. The values found in technical literature are either totally misleading or of uncertain value. The earliest values were derived by Berthier¹ and were based on the so-called Welter law which held that the union of one and the same quantity of oxygen with any of the elements gave the same amount of heat.²

Winkler followed the same method, but made some reference to the moisture content of the material, which was supposed to be about 9 per cent. The values obtained by both of these investigators are occasionally repeated in the literature.³ They are entirely at fault, and should be credited with only historical value.

Rumford in 1813 was the first to transmit the heat of wood as it burned to a measured quantity of water. The wood was dried in a chafing dish and, when seemingly dry, a piece of the weighed material was held by tongs under the open end of a tube through which the products of combustion were made to pass. The tube was surrounded by water and when the temperature had reached a certain point the fire was put out and the weight of the unburned

¹ JUPTNER, "Lehrbuch der Chem. Tech. der Energien," vol. 1, part I, p. 115, 1905.

² POOLE, "The Calorific Power of Fuels," p. 10, 1898.

³ GROVES and THORPE, "Chemical Technology" vol. 1, p. 360.

wood determined.¹ Schödler and Peterson in 1836² dried their samples to constant weight, but based their heat values on the weight of oxygen used in burning 1 kg. of material, thus reverting to the same principle as that used by Berthier.

Gottlieb in 1883³ used wood which had been dried to constant weight at 115°C. His apparatus was of the constant pressure type wherein the wood was burned in a current of oxygen and the heat imparted to a known quantity of water. His results therefore were the most trustworthy up to that time and do not seem to have been superseded by other values since.

A series of tests at the University of Illinois carried out in 1916⁴ made use of American woods and had two objects in view (a) to determine the practicability of drying wood to the moisture-free state without alteration or loss of combustible, and (b) to make careful heat determinations by use of modern apparatus. A calorimeter of constant volume with platinum lined bomb of the Mahler type and adiabatic insulation was employed. A table of values is given showing the actual moisture content for well seasoned wood of several varieties, and the heat values calculated to both the "as-received" and the "dry" or "moisture-free" basis.

For comparison, the best values in the literature at the present time, those of Gottlieb, are given in so far as there are corresponding varieties of woods in the two series of results.

TABLE X.—HEAT VALUES FOR AMERICAN WOODS

Wood	Moisture 1 hr. at 105°C.	B.t.u. "as- received"	B.t.u. "dry basis"	Gottlieb "oven dry"	Differ- ence
Pine.....	8.88	8,050	8,836	9,153	+317
Oak.....	8.35	7,841	8,556	8,316	-240
Hickory.....	10.30	7,578	8,448		
Cherry.....	8.85	7,860	8,623		
Birch.....	10.18	7,597	8,458	8,586	+128
Poplar..	10.69	7,716	8,640		

¹ *Nicholson's Journal*, pp. 105, 319, 1813.

² *Annalen der Chemie*, vol. 17, p. 139.

³ *Jour. Pract. Chemie*, vol. 28, p. 412, 1883.

⁴ "Calorific Value of American Woods." *Jour. Ind. Eng. Chem.*, vol. 14, p. 935, 1922.

CHAPTER XIV

PETROLEUM, DISTILLATES AND ALCOHOL

Use.—The use of petroleum as a fuel has greatly increased in recent years. A number of factors enter into the case. The development of the great oil fields of Texas, California and Mexico brought in oils of the heavier type with a low percentage of the lighter distillates. In a region where other fuels were lacking these heavier oils went largely into service for direct burning as fuel. With the practice of “topping” and the extension of cracking processes to these and the lighter oils a residual by-product known as “fuel oil” came into extensive use.

Output.—Out of a total annual output of 355,000,000 bbl. in the United States in 1918 about 180,000,000 bbl. were used as fuel and gas oil. Of this approximately 40,000,000 bbl. were used for direct burning in locomotives, thereby replacing substantially 10,000,000 tons of coal. The Navy used about 5,000,000 bbl. One hundred million barrels of gasoline were made and 20,000,000 bbl. of lubricants were produced.

The chief factors to be considered by the chemist are the amount of water present, the sulphur content, the heat value per pound, and a fractional distillation showing the amount of distillate over at least three ranges of temperature.

Water may vary in amount from a trace up to 60 per cent. It is determined by means of the centrifugal, diluting the sample 1:1 with gasoline, or by the usual fractional distillation methods.

Heat Values.—For heat determination an oxygen-bomb calorimeter has the advantage that a larger amount, approximately 1 gram, may be taken for the test. Thirty to forty atmospheres should be used and the bomb washings are especially adapted for deriving the factor for sulphur.

With the peroxide bomb the amount of oil is practically limited to 0.2 or 0.3 gram, and the sulphur in the solution resulting from the fusion is not easily determined by photometric methods if less than 0.1 per cent.

A method of calculation is in vogue based upon specific gravities, as follows:¹

$$\text{B.t.u.} = 18,650 + 40 (\text{Baumé degrees} - 10)$$

The depletion of the petroleum supplies of the world and the great expansion in the use of internal combustion engines puts up to the chemist many vital problems in the matter of developing substitutes for petroleum and gasoline. The internal combustion engine whether of the gas, gasoline, or Diesel type has developed a demand for fuels of the mobile type and new and augmented supplies of such fuel must be continually forthcoming. Heavy-oil residues of such a consistency as to be semi-solids at reduced temperatures are, by suitable mechanical appliances, brought into the field of liquid fuels. Even tar, at one time considered impossible of such application, is now a very practical source of heat both in connection with steel furnaces and for steam generation.

Distillates.—As already noted the gasoline output of the United States at the present time is approximately 100,000,000 bbl. Consumption is increasing more rapidly than production. In consequence new material of low vaporization temperature is being sought to augment the fuel supply of this type. For this purpose benzene and alcohol are the most promising. Casing-head gasoline obtained by stripping natural gas of its condensable products is also a very considerable source of supply. By mixing with heavier oils of the kerosene type and also some of the regular gasoline fractions, a blended gasoline is made which enters very largely into the motor-fuel supply of the present day. The method of compounding suggests the method for analysis which has been developed by the U. S. Bureau of Mines.² Compounded or synthetic gasolines are variable in composition. Benzene recovered from coke oven gas has the disadvantage that it freezes at 5.4°C. It mixes however in all proportions with either gasoline or alcohol, which suggest the natural and commonly employed methods of compounding.

The range of material involved in volatile liquid fuel supplies is thus seen to be a very wide one, with consequent variation in

¹ SHERMAN and KROFF, *Jour. Am. Chem. Soc.*, vol. 30, p. 1626.

² DEAN, E. W., U. S. Bureau of Mines, *Tech. Paper* 166, 1917.

heat value. It is evident that the determination of calorific values becomes an important feature. About the only difficulty to be encountered results from the volatility of some of the material to be worked with.

In determining the calorific values of highly volatile substances some special procedure must be observed for avoiding loss in weighing out the sample or in preparing the charge.

A container for the volatile liquid may be made in the form of a very thin-walled glass bulb of about 1 cm. diameter and having a short capillary stem of 2 or 3 cm. These are readily prepared by the analyst from soft-glass tubing which has been drawn out into a capillary 1 or 2 mm. in diameter. By softening the end of such a capillary in the flame, it may be blown into a small bulb of suitable size. Such a bulb may be filled by warming the weighed bulb and immersing the capillary in the liquid to be analyzed. By contraction of the air a small amount of the liquid is drawn into the bulb, and by repeating the process the bulb may be filled to any desired extent. It is then sealed and weighed. Bulbs of this sort should be used with either the oxygen bomb or sodium peroxide calorimeter. With heavier or slightly volatile oils they are not necessary. When used in the oxygen bomb the bulb with the volatile liquid should be placed in the bottom of a 10 cc. platinum or Irium crucible and the fuse wire wrapped two or three times around the capillary stem. The heat of the current will be sufficient to rupture the bulb and, being discharged at the bottom of the crucible, the vapors must rise and flow over the edge in the process of combustion. In the case of the sodium peroxide bomb, the glass bulb is placed so that it rests on the bottom of the fusion cup and is covered completely by the chemical. Just before closing the cup, the bulb is broken by means of a glass rod pressed downward in such a manner as to rupture the bulb. The cover is then at once fastened in position and the contents shaken thoroughly for uniform mixing. In this manner highly volatile liquids may be handled in either type of instrument.

Alcohol.—Volatile fuels of the hydrocarbon type may increase in cost to a point where alcohol may enter the field as a competitor. It is even now receiving* considerable attention because of certain inherent properties when used in internal combustion

engines. In mixtures with hydrocarbons it promotes a more efficient combustion and has the added advantage that it carries into the combustion chamber a certain ratio of water vapor which serves as a protective medium for the hydrocarbons, reducing their tendency toward decomposition or cracking and the consequent deposition of carbon. While alcohol has no ash it has a large percentage (34.8) of combined oxygen which approximately represents the inert material. It was formerly denatured by adding 0.5 per cent of benzine and 10 per cent of methyl (wood) alcohol to make it poisonous and not easily purified by re-distilling. This is known as formula No. 1 (now suspended). Methyl alcohol is at the present time practically all absorbed in the manufacture of formaldehyde, extensively used as an anti-smut reagent in the treatment of grain.

The U. S. Bureau of Internal Revenue has published¹ four complete and 33 special formulas. The former are allowable for any use desired, while the latter are usable only under special regulations for specific purposes. The completely denaturing formulas use a small amount of methyl alcohol, not exceeding 2 per cent, and pyridine bases 1 per cent. Other variations prescribe benzol, $\frac{1}{2}$ per cent, benzine (kerosene), 0.5 per cent, etc.

From the fuel standpoint, formula No. 3 is the most interesting, as follows:

Ethyl alcohol.....	100 parts by volume
Ethyl ether.....	5 parts by volume
Benzine.....	2 parts by volume
Pyridine.....	1 part by volume

¹ Regulation 61, p. 97.

CHAPTER XV

FUEL GAS

Types.—The gas industry was originally developed as a lighting proposition. With the advent of electricity it began to take second place in that field. Today the industry is in a transition stage with the logic of events clearly pointing to the ultimate utilization of gas substantially as a fuel. The advent of natural gas has doubtless been a factor also in the change, at least by way of illustration as to the advantages of fuel in the gaseous form. The use of natural gas has increased in the last 35 years from an annual production of less than 50,000,000,000 to over 900,000,000,000 cu. ft. The total yield of gas from all sources in 1917 was approximately, 1,450,000,000,000 cu. ft. and of this 222,000,000,000 or 15 per cent were supplied to domestic users. Of this probably not over 20 per cent or 3 per cent of the total was used for lighting purposes. Other factors also enter into the case. Over 75 per cent of the gas supplied to cities at the present time is so called water-gas which, because of candlepower requirements, must be carbureted with gas oil. With an average of 3 gal. of such oil used for 1,000 cu. ft. of gas made, the manufacturing cost per thousand feet with oil at 10 cents a gallon approaches very nearly to the selling price. For these and attending reasons the public is gradually realizing that candlepower and expensive oil for carbureting go together, and that a gas with less luminosity can be made at a much lower price. The uncertain and diminishing supply of gas oil adds to the argument for abandoning the candle power standard so that a decided trend is evident toward the heat unit basis and a lowering of the requirement in that particular from 600 B.t.u. per cubic foot, which was formerly a very nearly universal standard. The ultimate standard when settled upon will doubtless bear some relation to the number of heat units carried by the uncarbureted gas.

TABLE XI.—TYPICAL COMPOSITION OF THE MORE COMMON FUEL GASES
Assembled from various sources

Types of gas	CO ₂	O ₂	Illuminants		H ₂	CO	Paraffins		N ₂	Gross B.t.u.
			C ₂ H ₄	C ₂ H ₆			CH ₄	C ₂ H ₆		
Natural.....	0.2	0.4	0.3	...	1.6	0.4	94.1	...	3.0	970
Coal gas (horizontal retorts)...	0.5	0.5	4.0	...	46.0	6.0	40.0	...	3.0	670
Coal gas (vertical retorts)...	2.5	0.3	3.4	...	52.3	10.7	26.9	...	3.9	552
Water gas (from coke).....	4.0	0.5	45.7	45.8	2.0	...	2.0	322
Water gas (from bituminous coal).....	5.4	1.1	0.9	...	41.9	34.0	7.5	...	9.2	335
Carbureted water gas.....	2.9	0.5	10.0	4.5	27.9	25.3	25.9	...	3.0	765
Pintsch.....	35.00	...	4.5	0.5	60.00	1,500
By-product oven (Koppers)...	1.7	1.4	4.6	...	46.6	7.1	33.20	...	5.4	660
Low-temperature carboniza- tion below 800°C.....	3.9	0.8	1.5	1.6	47.3	4.3	33.2	4.5	2.9	670
Producer.....	2.5	...	0.4	...	12.0	27.0	2.5	...	55.6	157
Blast furnace.....	12.7	0.3	25.5	61.5	87

With the exhaustion of our natural gas supplies and the modifications in the standard requirements for house use now taking place, it is evident that the production of the future will come in the main from installations of the by-product oven type and from generators of the water gas type, using either coke or raw coal. Problems of manufacture and purification, standards of quality, and methods of analysis can not be elaborated in this connection. Brief reference should be made however to methods for determining heating values.

Heating Value of Gas.—Calorimeters for determining the heating value of gases are of the intermittent and of the continuous flow type.

Hempel¹ makes use of an apparatus which burns a volume of gas in an atmosphere of oxygen, the heat being imparted to a known amount of water. By repeating the process using hydrogen under the same conditions as to volume and the amount of water heated, and reducing the temperature readings to the same temperature and pressure, the value of the unknown gas is found by a direct ratio, using an accepted value for hydrogen at standard conditions of temperature and pressure.

¹ HEMPEL'S "Gas Analysis," 3d ed., p. 437.

The author¹ made use of two calorimeters, Fig. 20, in parallel burning equivalent volumes simultaneously of hydrogen and the unknown gas under identical conditions as to temperature

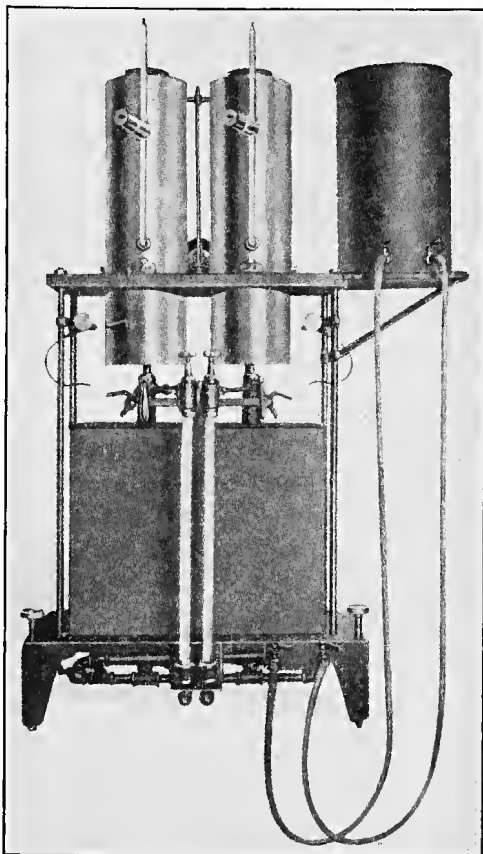

FIG. 20.—Parr non-continuous gas calorimeter.

and pressure. Compensations for humidity of the air and barometric pressure were therefore self-adjusting, and since equivalent volumes were burned the amount was not essential, hence a meter was unnecessary.

¹ *Jour. Ind. and Eng. Chem.* vol. 2, p. 337, 1910.

In the original testing out of this instrument in comparison with one of the Junker type a constant difference was observed wherein the latter gave lower results of from 3 to 8 B.t.u. per cubic foot. The suggestion was made at the time¹ that the discrepancy was due to variations in the humidity of the air and the fact that the Junker instrument did not make note of it. This possibility was verified by the Committee on Calorimetry of the American Gas Institute.²

Following the recommendations in that report, it has become the practice to correct for humidity as well as barometric pressure and temperature.

Although instruments of the non-continuous type have certain advantages, such as the ability to operate on relatively small samples, they lack the advantage of continuous flow and the opportunity of taking readings at any time. Indeed the trend of development in the matter of determining the heating value of combustible gases must inevitably be toward an instrument which will make continuous record of the quality of the output.

Flow Calorimeters.—The continuous flow calorimeter most commonly in use is of the Junker type.³

The instrument is shown in Fig. 21.

The gas is conducted through a wet meter, then preferably through a pressure equalizer, after which it goes to a Bunsen burner. The products of combustion give up their heat to water under exact control as to temperature and mass. There are specific modifications to be made including temperature corrections for both the barometer and the meter readings, also for variations in temperature between the inlet water and that of the room, as well as for the humidity of the air.

From prepared tables (see Appendix, Table IV) are found the correction factors to be applied to the meter readings to give equivalent volumes at 60°F. and 30 in. of mercury. After applying calibration corrections for inlet and outlet water temperature readings the true rise in temperature of the water

¹ *Jour. Ind. Eng. Chem.*, vol. 2, p. 337, 1910.

² *Report of the Committee on Calorimetry for the Seventh Annual Meeting*, 1912.

³ JUNKER, HUGO, *Jour. fur Gasbel.*, vol. 36, p. 81, 1898.

is obtained which, with the reduction of gas volume and weight of the water, gives the essential factors for substituting in the formula:

$$\text{Heat value} = \frac{\text{Mass } (t' - t)}{\text{Volume in cubic feet}}$$

If the mass is expressed in pounds, t in degrees Fahrenheit, and V in cubic feet, the result will be B.t.u.'s per cubic foot.

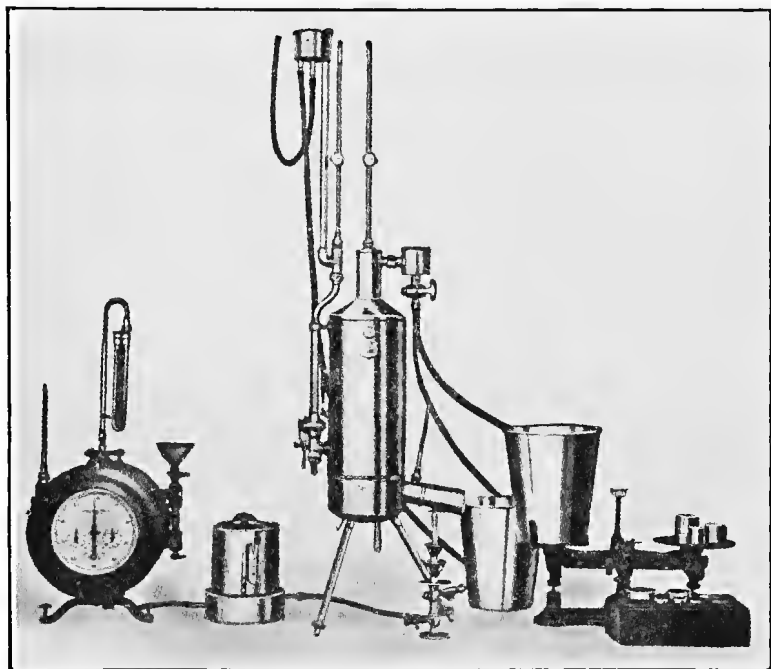

FIG. 21.—Junker continuous flow calorimeter.

A factor for radiation changes is also applied where there is a difference between the inlet water and that of the room. This factor may be found in Table XII. The correction is added if the inlet water is warmer than the air of the room and subtracted, if colder.

TABLE XII.¹—CORRECTIONS FOR DIFFERENCE BETWEEN INLET-WATER TEMPERATURE AND ROOM TEMPERATURE

Used with the Junker calorimeter

Room temperature, degrees Fahrenheit	Corrections in B.t.u. per 1°F.	
	For calculating total heating value	For calculating net heating value
50	0.5	0.4
60	0.6	0.4
70	0.7	0.4
80	0.8	0.4
90	0.9	0.5
100	1.0	0.5

High and Low Heat Values for Combustible Gases.—For purposes of standardization of output and control, it is generally conceded that the high or total heating value is the more logical standard of reference. However, for many technical applications, especially in the use of gas for internal combustion engines where all of the products of combustion are delivered above 100°C., the net or low heat values are the most significant.

In the Junker type of instrument the water of condensation from the combustion of the gas is measured. The number of cubic centimeters per cubic foot multiplied by 0.600 will give the heat in calories which would be required to vaporize the water condensed. The amount of condensed water therefore in cubic centimeters, multiplied by 3.968×0.600 will give the amount of heat in B.t.u. to be subtracted from the total heat to give the net heat value.

Ammonia and Sulphur.—Ordinarily a limit of 5 grains of ammonia per 100 cu. ft. of gas is prescribed. The need for any special attention to this impurity does not often occur, however, since the ammonia is easily removed and has a value which makes its recovery profitable. Its presence, moreover, is injurious to gas meters. Sulphur occurs in manufactured gas mainly as hydrogen sulphide, H_2S . Carbon and hydrocarbon compounds of sulphur are usually present, but in much smaller amount. In coal gas, ordinarily about $\frac{5}{8}$ of these compounds are carbon bisulphide and the remainder are thiophens and mer-

¹ From U. S. Bureau of Standards *Circular* 48.

captans. It is not easy to prescribe a limit for sulphur, owing to the wide variations both in operating conditions and in the type of materials which must be used in gas manufacture. The Bureau of Standards¹ recommends a limit of 30 grains of total sulphur per cu. ft. of gas. Whatever the form in which sulphur occurs, in the process of combustion it burns to SO_2 and SO_3 . The presence of more than a trace of H_2S shows carelessness in the manufacturing process.

Apparatus for the Analysis of Fuel Gases.—To meet the conditions of analysis for the constituents found in fuel gases, it is of great advantage to have assembled as permanent equipment in the laboratory a unit outfit capable of determining all the constituents usually found in a fuel gas. Investigational studies, especially, have been materially advanced as a result of greatly improved apparatus for carrying out the analysis of combustible gases, especially those of the type devised by Col. G. A. Burrell.² For laboratory use where portability is not an essential feature, such an installation combining all of the features for carrying out the processes will be found exceedingly convenient and satisfactory. The development of this type of instrument has greatly simplified the processes involved. For control work and the usual technical analysis of gases, the apparatus as used in the author's laboratory is shown in Fig. 22 and Fig. 44. It does not differ in any essential feature from the Burrell apparatus except that a saturated salt solution is used in the leveling tube, and for greater convenience, a companion tube for leveling is connected to the gravity tube by a Y with a stop cock in the main connection below the Y, and another at the top of the equalizing tube.

Analysis of Fuel Gas.—The analysis of fuel gas makes use of methods of absorption and combustion.

1. Carbon dioxide is absorbed in a solution of 100 grams KOH in 150 cc. of water. The reagent may be used until it approaches the point of saturation, indicated by the slowing up of the reaction.

2. Oxygen is absorbed by an alkaline solution of pyrogallol.

¹ Standards for Gas Service, *Circular* 32, p. 101, 1915.

² JONES and NEUMEISTER, An improved Orsat apparatus for gas analysis: U. S. Bureau of Mines, *Bull.* 92; *Chem. and Met.*, vol. 21, p. 734, 1919.

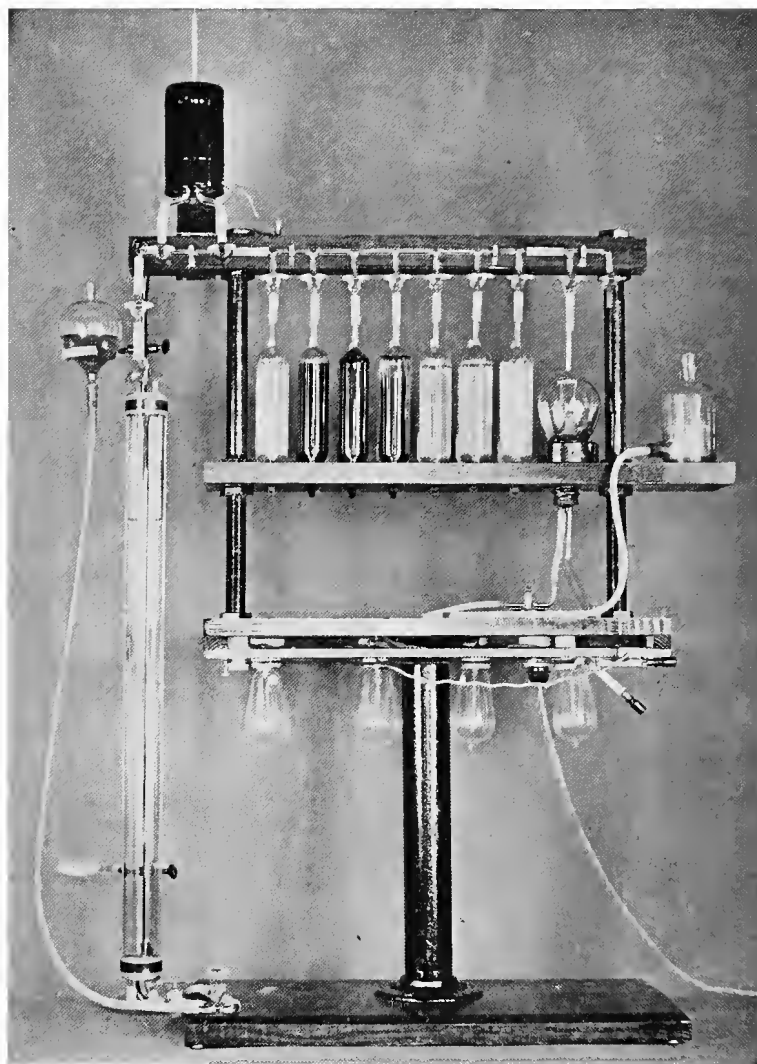

FIG. 22.—Modified Orsat apparatus for analyzing gases.

The usual mixture is 1 part of KOH with 2 parts of water, and this solution mixed in equal volumes of pyrogallol solution, made by dissolving 1 part of pyrogallol in 3 of water. According to Professor White,¹ the solution may not be used with safety beyond an absorption of about 8 volumes of oxygen to 1 volume of solution on account of the formation of carbon monoxide in the reaction.

3. Ethylene is absorbed in a solution of bromine in water. If a few drops of bromine are kept in the pipette all the time, this reagent may be used indefinitely. After the absorption of the ethylene has been completed, it is necessary to pass the gas into the KOH pipette to remove the bromine that has vaporized.

4. Benzene is absorbed in a solution of 15 to 20 per cent fuming sulphuric acid. This reagent need not be renewed as long as it fumes readily, indicating the presence of free SO₃. As with the bromine, so must the SO₃ be removed by passing the gas back into the KOH pipette.

5. Hydrogen and Carbon Monoxide are determined by the method of fractional combustion as suggested by the work of Campbell.² He found the combustion point for gases in contact with pure copper oxide to be as follows:

TABLE XIII.—COMBUSTION TEMPERATURES FOR GASES IN CONTACT WITH COPPER OXIDE

Gas	Reacting temperatures with pure CuO, degrees Centigrade (CAMPBELL)
CO.....	100 to 105
H ₂	175 to 180
C ₃ H ₆	270 to 280
C ₂ H ₄	315 to 325
C ₄ H ₈ (iso).....	320 to 330
CH ₄	650 to 750 in air ³

The low range of temperatures for carbon monoxide and hydrogen compared with marsh gas has been made the basis for a method of fractional combustion, whereby the two low-burning

¹ WHITE, A. H., "Technical Gas and Fuel Analysis," p. 34, 1920.

² *Am. Chem. Jour.*, vol. 17, p. 688, 1895. See also JAGER, *Jour. Gasbeleucht.*, vol. 41, p. 764, 1898.

³ DIXON and COWARD, *Jour. Chem. Soc.*, vol. 95, p. 519, 1909.

gases are removed without affecting the paraffins. Since the hydrogen in burning to water disappears, the contraction represents the H_2 , and since the CO burns to CO_2 , each volume of CO_2 indicated from absorption in the KOH solution represents one volume of CO.

The combustion takes place most satisfactorily by maintaining the copper oxide at about $300^\circ C$. After the combustion has been completed, it is necessary to sweep out the tube containing the CuO with pure nitrogen to remove the gas being analyzed and any CO_2 formed.

6. Methane and any remaining hydrocarbons of the paraffin series are determined by the method of slow combustion over mercury. The method of Coquillon (1876), who first made use of the platinum spiral, has received its best development from Professor L. M. Dennis.¹ One of the main objections to the method has been the tendency toward the formation of oxides of nitrogen, resulting from the incandescent spiral. Dennis and Hopkins² propose to obviate this difficulty by use of pure oxygen instead of air.

The methods thus indicated under (5) and (6) for determining the various combustibles are especially provided for in the apparatus as shown, Fig. 22. It will be noted that there are no complications involved in developing the volumes for hydrogen and carbon monoxide as discussed under (5). To deduce the volumes for the mixed hydrocarbons of the paraffin type as under (6) is somewhat more involved. However, the matter is simplified in that all of the constituents have been removed at this stage excepting the paraffins and nitrogen. Then while a mixture of combustible gases remains, it consists of a homologous series, which is of material aid in devising a method of computation—for arriving at the original volume.

Computation of Volume of Paraffins from Analytical Data.—After the process of burning the paraffin gases, four values are available upon which to base the calculations. (1) The volume of the sample employed. (2) The volume of the oxygen used. (3) The volume of the resultant gas after combustion. (4) The volume of carbon dioxide in the resultant gas.

¹ DENNIS, L. M., "Gas Analysis," p. 147, 1913.

² *Jour. Am. Chem. Soc.*, vol. 21, p. 398, 1899.

By subtracting (3) from the sum of (1) and (2), the contraction due to the condensation of water formed from the combustion of the combined hydrogen is obtained, and from this contraction, and the volume of carbon dioxide formed, can be calculated the volume of the paraffin hydrocarbons in the original sample of gas. Also the index of the average composition of the paraffins can be determined.

The formula for determining the volume is: $V = \frac{2C - CO_2}{3}$

and for the index of the average composition is: $n = \frac{CO_2}{V}$. The derivation is as follows:

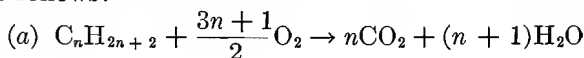

From (a) the contraction is

determined as

$$(b) \quad C = V + \frac{(3n+1)V}{2} - nV$$

$$C = \frac{2V + 3nV + V - 2nV}{2}$$

$$C = \frac{nV + 3V}{2}$$

From (b) (c) $nV = 2C - 3V$

also from (a) . . (d) $nV = CO_2$

By solving the two equations

(c) and (d) (e) $V = \frac{2C - CO_2}{3}$

Then from (d) . . (f) $n = \frac{CO_2}{V}$

The value V is the correct volume of the hydrocarbon gas no matter how many of the homologues are present and in like manner the value, n , is the average composition of the mixture. If methane was the only homologue present, the value for n would be unity. Also if ethane was the only constituent the value of n would be 2. This may be proven by solving for n from the equations

$$CH_4 + 2O_2 \rightarrow CO_2 + 2H_2O \qquad n = \frac{1 \text{ vol. } CO_2}{1 \text{ vol. } CH_4} = 1.00$$

and $2C_2H_6 + 7O_2 \rightarrow 4CO_2 + 6H_2O \qquad n = \frac{4 \text{ vol. } CO_2}{2 \text{ vol. } C_2H_6} = 2.00$

It is very seldom that a value for n of more than 2 is obtained and though this does not mean that there are none of the homologues higher than ethane present in the gas, it does show that methane and ethane predominate. The volume of hydrocarbons is usually considered as being only methane and ethane and is differentiated into these two by applying the portion of n greater than unity as a factor which when taken times the volume V will give the volume of ethane. Methane will then be V minus ethane and the volumes of these two constituents as determined will be reported in per cent on the basis of the original sample of gas.

The difference between the sum of all the constituents so far determined and the original 100 cc. of sample is considered as nitrogen. Then of necessity the nitrogen value must contain the total error of the several determinations.

An analysis of a sample of gas from a low-temperature carbonization test on Illinois coal follows:

GAS SAMPLE NO. 175-2
Illustrating the calculations for the paraffins

Constituents	Volume, 100 cc.	Per cent	Calculations
CO ₂	95.4	4.6	
O ₂	94.5	0.9	
C ₂ H ₄	90.1	4.4	
C ₆ H ₆	89.2	0.9	
H ₂	43.9	45.3	
New volume.....	70.1	-	
CO.....	61.3	8.8	$V = \frac{2C - CO_2}{3}$ and $n = \frac{CO_2}{V}$
O ₂ added.....	156.0	
Total.....	217.3	$V = \frac{131.6 - 33.4}{3}$
After combustion.....	151.5	
Contraction.....	65.8	$V = \frac{98.2}{3} = 32.7$
CO ₂ formed.....	33.4	Then $n = \frac{33.4}{32.7} = 1.021$
CH ₄	32.0	And $32.7 \times 0.021 = 0.7$ cc. C ₂ H ₆
C ₂ H ₆	0.7	
N ₂	2.4	
Total.....	100.0	

Heat Values by Calculation.—It will be seen from the foregoing that with an apparatus which compares favorably with a calorimeter in the matter of facility and speed of operation, the method of obtaining heat values for combustible gases by analysis and calculation is given a very much more favorable status. This development will appeal especially to those interested in gas engine work where exact determinations for the low or net heat values are desired and which require for their satisfactory derivation an analysis of the gas.

The gross and net heat values in B.t.u. for a number of different gases are given in Table XIV and since the values for all the combustible gases found in the foregoing analysis are included, it is possible to calculate with a good degree of accuracy the heat value of the original gas sample. The heat values given are for standard conditions, 60°F. and 30 in. of mercury, and since the per cents, as determined, hold for the gas under any temperature and pressure condition, all that is necessary in calculating the total heat value of the sample is to obtain a summation of the per cents of the combustible constituents times their respective heat values. Thus we may calculate the gross B.t.u., from the values in the table, in the following manner:

TABLE XIV.—HEAT OF COMBUSTION FOR THE MORE COMMON GASES

Gas	Formula	Gross values ¹ calories per gram molecule	Gross values B.t.u. per cubic foot at 60°, 30 in. mercury	Net values ² B.t.u. per cubic foot	Gross values ³ B.t.u. per cubic foot at 60°, 30 in. calculated from net value
Hydrogen.....	H ₂	68,360	326.2	271.8	320.9
Carbon monoxide..	CO	67,960	323.5	320.9	321.0
Methane.....	CH ₄	211,930	1,009.0	908.5	997.9
Ethane.....	C ₂ H ₆	370,440	1,764.4	1,604.0	1,688.7
Propane.....	C ₃ H ₈	529,210	2,521.0		
Butane.....	C ₄ H ₁₀	687,190	3,274.0		
Ethylene.....	C ₂ H ₄	333,350	1,588.0	1,511.4	1,590.6
Propylene.....	C ₃ H ₆	492,740	2,347.2		
Butylene.....	C ₄ H ₈	650,620	3,099.12		
Acetylene.....	C ₂ H ₂	310,050	1,476.7	1,424.4	1,486.4
Benzene (vapor)....	C ₆ H ₆	799,350	3,807.5	3,571.5	3,634.0

¹ WHITE, A. H., "Technical Gas and Fuel Analysis," p. 301, 1920. Gross values; temperature of products of combustion being reduced to 64.4°F.

² FELBECK, GEORGE T., Thesis: "A Mathematical Determination of the Maximum Pressure and the Extent of Combustion in the Gas Engine." Univ. of Ill., 1921.

³ Gross values calculated from "Felbeck's Net Values," using formula as proposed by Goodenough, G. A., Professor of Thermodynamica, University of Illinois.

GAS SAMPLE No. 175-2

Calculation of total heat value

COMBUSTIBLE CONSTITUENT	PER CENT BY ANALYSIS		ACCEPTED B.T.U.	=	RESULTING HEAT VALUE
C ₂ H ₄	4.4	×	1,588.0	=	69.9
C ₆ H ₆	0.9	×	3,807.5	=	34.3
H ₂	45.3	×	326.2	=	147.8
CO.....	8.8	×	323.5	=	28.5
CH ₄	31.4	×	1,009.0	=	316.8
C ₂ H ₆	1.0	×	1,764.5	=	17.6
Total B.t.u. of gas.....					614.9

The values above are the usually accepted heating values for the several constituents, and may be found in most texts and handbooks on this subject. They represent the high or gross values since the determinations were carried out at room temperature. As previously mentioned, the net or low-heating value of a gas is often desired and Table XIV includes these values for the various constituents. There is also given a second set of gross values which have been calculated from these net values. There are some arguments in favor of proceeding from the net values as a basis and from such values, derive the high or gross factors. Calculations thus made on the particular sample above referred to show results as follows: comparison being made with the indicated results from a Junker calorimeter.

		NET OR LOW	GROSS OR HIGH	
Gas sample No. 175-2	{	Determined by Junker calorimeter.....	554.4	620.0
				614.9 ²
		Calculated.....	551.3 ¹	606.5 ³

In case the question is raised as to the presence of higher homologues of the paraffins which might influence the heating value, it is well to note that the value $V(n(757) + 251)$,⁴ derived from the heat of combustion of C and H in C_nH_{2n+2}, will give the gross value in B.t.u.'s for the total paraffins in the sample. In this case $32.4(1.031(757) + 251) = 334.2$ B.t.u., while the sum

¹ Calculated from analytical data using net values, from Table XIV.

² Calculated from analytical data using gross values as found in handbooks.

³ Calculated from analytical data using gross values from Table XIV, derived from net values.

⁴ EARNSHAW, E. W., Water gas: *Jour. Franklin Inst.*, vol. 146, pp. 161-176.

of the heat values for methane and ethane as calculated from their per cents is 334.4. This shows the possibility of calculating the gross values for the paraffins without differentiating into the homologues, and in cases where it is impossible to differentiate, as where n is greater than 2, it is still quite possible to obtain the correct heating value of the gas by applying the above formula.

NOTE.—One rather remotely possible source of error in calculating the B.t.u. from the analytical results as obtained might be mentioned and that is, in the case of higher homologues of the olefin series or other unsaturated hydrocarbons, and as there is no way of determining or differentiating these, this possible error is beyond control. However, it is not probable that unsaturated compounds other than ethylene often occur in the gases analyzed, and errors from this source would doubtless be less than the experimental errors incident to the processes involved.

CHAPTER XVI

FLUE GAS

Gas Volumes.—Air has essentially the composition by volume of 21 per cent of oxygen and 79 per cent of nitrogen. In passing through the fuel bed the nitrogen is unchanged, being chemically inactive, and proceeds into the flue spaces in the same form in which it entered the furnace. The oxygen, on the contrary, enters into chemical reaction, combining with the carbon to form CO_2 and CO and with the hydrogen to form H_2O . As in all chemical processes, an excess of the reagent must be present in order to accomplish a rapid and complete reaction. There will always be found, therefore, in the flue gases a very considerable amount of excess or unused oxygen. The essential constituents, therefore, to be determined in the analysis of flue gases are:

1. CO_2
2. O_2
3. CO
4. N_2 (by difference)

In the combustion of carbon, the reaction which occurs may be represented by the formula $\text{C} + \text{O}_2 = \text{CO}_2$. This means that for each volume of oxygen one volume of CO_2 results. If, therefore, pure carbon were burned and the exact amount of air were supplied to completely represent the volumes indicated in the above equation, the resulting flue gas would be composed of 20.78 per cent of CO_2 and 79.22 per cent of nitrogen. This, therefore, would represent the extreme limit of theoretical possibility as to the percentage of the volume of CO_2 in such a flue gas. However, from the principle already stated as to the necessity of an excess of reagent, the rapid and complete oxidation of the carbon can only be effected by having an excess of oxygen, at least 50 per cent more than that utilized in the combustion, and even at this ratio the oxygen would begin to be sufficiently

low in amount to result in the formation of a very considerable quantity of CO. From actual experience it would seem that a content of CO₂ in the flue gases of, say, 12 per cent approaches the limit of practicability, while doubtless from 8 to 10 per cent of CO₂ would represent conditions which are above the average in practice.

It should be borne in mind also that while carbon constitutes the larger part of the fuel content, the combustion of hydrogen (which on the average represents from 3 to 4 per cent of the coal), would be represented by the formula

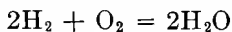

That is, one volume of oxygen results in two volumes of water vapor. Now, since in the process of analysis the water vapor condenses and does not appear in the results, it must follow that the nitrogen which accompanied the original oxygen into the furnace in this case is left alone without an accompaniment of gaseous product corresponding to the CO₂ as in the case of the combustion of carbon. To this extent, therefore, the ratio of theoretical CO₂ in the flue gases is diminished. From these considerations it will appear that the uses which may be made of the constituents are: First, a very fair estimate of efficiency of the firing may be obtained from the percentage content of CO₂ in the flue gases. If, for example, it is known that for the boiler setting and equipment of a given furnace, it is capable of carrying on combustion to an extent which will be represented by 10 per cent of CO₂ in the flue gases, then when the flue gases show only 5 per cent of this constituent, there is evidence of carelessness in firing which is capable of correction. Second, from the factors involved relating as they do to the constituents of the air, nitrogen and oxygen, and also to one constituent of the coal, carbon, and all in the gaseous form, it is easy to calculate, by means of the common gas laws, the weight of air used per pound of fuel burned. This furnishes a ready method for calculating other necessary data as, third, the ratio of air entering the combustion zone to the air actually entering into the combustion, and, fourth, the loss of heat passing up the chimney. This factor is most conveniently derived after having transferred the gas volumes to weight as under No. 2 above,

Sampling and Analysis.—According to Professor White¹ “the problem of obtaining a representative sample of a gas for analysis presents in many cases more difficulties than the analysis itself.” These difficulties relate chiefly to leakage in the boiler setting, irregularity of flow in the cross-section of the chimney or gas conduit, chemical reaction with the tube used for sampling, faulty or leaky connections, solubility of the sample in water, etc. The avoidance or minimizing of these difficulties is a problem for each plant. In general the leakage in the boiler setting should be remedied or minimized by a liberal use of some sort of luting material on all cracks or openings not intentionally provided for draft purposes. The point for taking the sample should also be as near the combustion zone as possible. In cases where it is desired to take samples within the zone of combustion, a special collecting device with a water-cooled conduit to avoid chemical change in the sample is necessary.

The difficulty of variations in the flow across the area of the conduit is best met by use of a multiple collecting device made by assembling a bundle of varying lengths of heavy pyrex glass or refractory tubing in a convenient holder, and held in place by portland, or still better “hytempite” cement. Rubber tubing should be confined to short connections only and use made of glass or metal tubing. None of the water used in aspirating or by gravity displacement in collecting the sample should remain in the holder in which the gas is collected for transmission to the laboratory. The analysis of the gas is not essentially different from that already discussed under fuel gases, except that a smaller number of processes are employed. The determinations ordinarily required in a flue-gas analysis are for CO_2 , O_2 , CO and N_2 by difference. The instrument most conveniently arranged for this work is the Orsat apparatus. It should be assembled in the simplest form and rugged in construction to meet the conditions of portability. The prescriptions for use have already been given in connection with the larger instrument, page 95. Indeed that apparatus is simply an enlarged or extended Orsat. It is adapted to all the uses intended for the smaller or Orsat apparatus proper except ready transportation. In the regular or small Orsat, carbon monoxide is determined by solubility in ammoni-

¹ WHITE, A. H., “Gas and Fuel Analysis,” pp. 1-13.

If, therefore, C represents the number of grams of carbon which deliver a flue gas with W^1 grams of nitrogen, then the weight of nitrogen per gram of carbon burned is $\frac{W^1}{C}$ or in terms of the assigned values,

$$W^1 = \frac{28N_2}{12(\text{CO}_2 + \text{CO})} \text{ or } \frac{7N_2}{3(\text{CO}_2 + \text{CO})} \quad (2)$$

Assuming for illustration a chimney gas of the following composition:

	PER CENT
CO ₂	10.0
O ₂	8.0
CO.	0.5
N ₂	81.5

resulting from the combustion of a coal having 70 per cent of carbon exclusive of the carbon lost in the ash. Then by substituting these values in equation (2) we have:

$$W^1 = \frac{7 \times 81.5}{3(10 + 0.5)} = 18.11 \text{ grams } N_2$$

That is, 18.11 grams nitrogen in the flue gases accompany the combustion of 1 gram of carbon. Similarly there would be 18.11 lb. of nitrogen in the flue gases from 1 lb. of carbon, and for a coal of 70 per cent carbon the weight would be $0.70 \times 18.11 = 12.68$ lb. N₂. Since nitrogen passes through the furnace unchanged the calculation to the equivalent weight of air entering is:

$$\begin{aligned} 77 : 100 &:: 12.68 : x \\ x &= 16.47 \end{aligned}$$

Hence the weight of air entering per pound of coal is 16.47 lb.

(b) *Ratio of Air Entering to Air Used.*—From the discussion under (a) the weight of oxygen per pound of carbon would be represented by the expression,

$$W^1 = \frac{32O_2}{12(\text{CO}_2 + \text{CO})} \text{ or } \frac{8O_2}{3(\text{CO}_2 + \text{CO})} \quad (3)$$

Substituting the values indicated under (a) we have

$$W^1 = \frac{8 \times 8}{3(10 + 0.5)} = 2.03$$

and for a coal having 70 per cent of carbon the weight would

be 1.42 lb. per pound of coal. Calculating the oxygen to the equivalent of air,

$$23 : 100 :: 1.42 : x$$

$$x = 6.17$$

Hence, the weight of air passing through unused is 6.17 lb. per pound of coal.

From (a) and (b) therefore

	POUNDS
Total air entering.....	16.47
Air unused.....	6.17
Air used.....	10.30

$$\frac{16.47}{10.30} = 1.60 \quad \text{Ratio of air entering to air used.}$$

(c) *The Loss of Heat Passing Up the Chimney.*—The factors which enter into the calculation of heat losses in chimney gases are (1) the weight of the flue gas per pound of fuel, (2) the specific heat in B.t.u. per pound, and (3) the rise in temperature or difference in temperatures ($t - t^1$) between the entering air and the gases as they leave the furnace.

1. The weight of the gas per pound of fuel may be readily derived from the formula for W as developed under (a) and (b) above. Letting W_v represent the weight of the mixed gases per pound of pure carbon, then by a similar procedure to that shown in equation (2) under (a) and equation (3) under (b) we would have for the total weight of all of the components per pound of carbon:

$$W_v = \frac{11\text{CO}_2 + 8\text{O}_2 + 7\text{CO} + 7\text{N}_2}{3(\text{CO}_2 + \text{CO})} \quad (4)$$

Or, since $\text{CO} + \text{N}_2 = 100 - \text{CO}_2 - \text{O}_2$ this expression may be still further simplified to read:

$$W_v = \frac{4\text{CO}_2 + \text{O}_2 + 700}{3(\text{CO}_2 + \text{CO})} \quad (5)$$

Assuming the coal used as in (a) and (b) to have 70 per cent of carbon (the carbon of the ash having been subtracted), then by substituting the percentage values for the chimney gas as

already indicated and multiplying by 0.70 we would have the weight of gases per pound of fuel:

$$W = \frac{4 \times 10 + 8 + 700}{3(10 + 0.5)} \times 0.70 = 16.62$$

Therefore for (1)

$$W = 16.62 \text{ lb. dry gases per pound of fuel.}$$

2. The specific heats of the various components, at constant pressure in B.t.u. per pound, calculated for the interval 60°F.-600°F.,

$$\text{CO}_2 = 0.222$$

$$\text{O}_2 = 0.217$$

$$\text{CO} = 0.245$$

$$\text{N}_2 = 0.2407$$

$$\text{H}_2\text{O} = 0.4673$$

From which it appears that an average specific heat of 0.24 for all the constituents exclusive of water vapor may properly be applied. Assuming, therefore, the $(t - t^1)$ values of 60° entering and 600° leaving, we have a total loss L for the dry gases thus:

$$L = 16.62 \times 0.24 \times 540$$

$$L = 2,154 \text{ B.t.u.}$$

Assuming a heat value of 12,000 B.t.u. for the coal per pound as fired, then the percentage loss, L^1 , would be,

$$L^1 = \frac{2,154}{12,000} \times 100$$

$$L^1 = 17.95 \text{ per cent.}$$

Other Losses.—In obtaining a heat balance as in boiler tests, other heat losses are taken account of. They include:

(A) The latent heat of vaporization of moisture.

(B) The heat of the water vapor passing off at the temperature of the chimney.

(C) The heat combustion of carbon to CO, instead of to CO₂.

(D) The unburned carbon in the ash.

(A) The water from which the loss of heat is calculated is made up of:

(a) The total hydrogen of the coal burning to H₂O, that is $H \times 9$.

(b) The free moisture of the coal.

(c) The moisture of the air as indicated by the relative humidity.

The sum of the three amounts of water referred to the unit of 1 lb. of coal multiplied by the factor for the latent heat of vaporization represents the heat loss in B.t.u. per pound of coal thus:

$$\left. \begin{array}{l} \text{B.t.u. loss} \\ \text{per pound} \\ \text{of coal} \end{array} \right\} = \text{Weight of H}_2\text{O} \times 966$$

(B) Having found the weight of water as under (A) the heat loss due to rise in temperature from room temperature, t , to 212° , and from 212° to temperature of flue gases, T , is found, using the specific heat factor for the water vapor, of 0.467, thus:

$$\left. \begin{array}{l} \text{B.t.u. loss} \\ \text{per pound} \\ \text{of coal} \end{array} \right\} = \text{H}_2\text{O} \times (212 - t) + \text{H}_2\text{O} \times 0.467 \times (T - 212)$$

(C) The heat loss due to the burning of carbon to CO instead of CO₂ is found by multiplying the weight of carbon thus entering into the reaction per pound of coal, by the difference between the calorific value of carbon burned to CO₂ and carbon burned to CO, thus:

$$\left. \begin{array}{l} \text{B.t.u. loss from CO} \\ \text{per pound} \\ \text{of coal} \end{array} \right\} = \text{Weight C in CO} \times 10,150$$

(D) The loss of heat due to combustible matter passing through with the ash unburned is found by determining the combustible in the ash as carbon, c , and referring it to the total refuse, r , in its proper proportion, x , to the ash, a , of the original fuel thus:

$$c : r :: x : a$$

Having the value, x , in percentage of the original coal as fired, then:

$$\left. \begin{array}{l} \text{Heat loss per pound} \\ \text{of coal from unburned carbon} \end{array} \right\} = x \times 14,550$$

In the use of the factor 14,550, it is assumed that the residual combustible in the ash is carbon only, with a heat value as indicated.

CHAPTER XVII

BOILER WATERS

THEIR EXAMINATION, CHARACTER AND TREATMENT

Water Analysis.—Waters are examined for two very different purposes. First, the object may be to determine the potability or sanitary character of the water; and, second, it may be desired to learn the behavior or value of the water for industrial uses. The requirements under each division are very different. In order to be sanitary, a water must be free from certain forms of organic matter which might indicate possible contamination with sewage or furnish a suitable breeding medium for disease germs. Within reasonable limits, the amount of mineral constituent is of little importance. On the contrary, however, the value of a water for industrial purposes depends very largely on the kind and amount of the dissolved mineral substance, while, as a rule, little importance is attached to the organic material present. This is especially true in the case of those waters which are to be used for boiler purposes, and it is this phase of the subject which is of immediate interest.

Source of the Mineral Constituents.—Natural waters in passing through the soil come in contact with certain products of decomposition and decay. Some of these substances, notably carbon dioxide, humic acid, etc., are taken up by the waters, in which condition their power to dissolve mineral matter is greatly increased. In this way the decomposition of feldspar, limestone, etc., is constantly going on, the result to the percolated water being that there is taken into solution varying quantities of silica, salts of iron, aluminum, magnesium, sodium, potassium, etc. As a rule, therefore, the less contact natural waters have had with the soil, or the more insoluble the earthy matter with which they have come in contact, the smaller will be the amount of mineral constituents dissolved; and, conversely, the deeper the

source of supply, the greater the opportunity for dissolving such material, and consequently the greater will be the amount of such substances in solution. For this reason it has been sometimes customary to divide waters into three classes:

1. *Surface water,*
2. *Shallow wells and spring waters,*
3. *Deep wells and artesian waters.*

Surface waters are such as are found in lakes, streams, and artificial ponds, and with these might also be considered cistern or rain waters; *shallow well waters* may be considered as those obtained from wells or borings which extend into the drift not to exceed 30 or 40 ft.; while *deep-well waters* may be considered those that are obtained from a depth of over 100 ft. These divisions are not sharply drawn, and, indeed, the classes merge into each other. This is more readily seen from the fact that many streams, for a large part of the year at least, are fed by waters which have their source in tile drains and springs. The system of underground drainage so largely carried on in these days, therefore, gives to the waters of smaller streams at least many of the characteristics of the water from the shallow wells. This feature is more pronounced during the dry months of the year, as, for example, in the late summer and fall. The amount of mineral matter, therefore, varies inversely as the volume of water in these minor streams. On the other hand, large bodies of water and larger streams, especially those in districts where they come in contact with the more insoluble formations, are remarkably free from mineral matter. This is especially noticeable in the waters of Lake Superior, and in many of the rivers of the north-central region of the United States. In certain regions, also, as in the delta of the Mississippi, water-bearing sands are sometimes found at very considerable depths, but with extremely small amounts of mineral matter present.

It will be seen from the above discussion that any classification based merely upon the source of a water will have little practical value. Before attempting any classification, however, based upon the character of the dissolved mineral constituents it will be necessary to review the processes by which these substances become a part of the water, and to note their properties and behavior under the conditions of actual use in steam boilers.

Chemical Characteristics of the Mineral Constituents.—Calcium carbonate, CaCO_3 , and magnesium carbonate, MgCO_3 , are the chief constituents of lime rock. Finely divided particles of these substances exist throughout all the clayey deposits of the drift region. The percolating water holding carbon dioxide, CO_2 , in solution has the property of a weak acid, $\text{H}_2\text{O} + \text{CO}_2 = \text{H}_2\text{CO}_3$, and in this form is a solvent for the above substances, forming *bicarbonates*, thus:

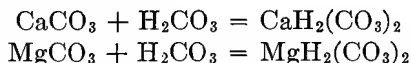

These dissolved bicarbonates are readily broken down by heat, thus:



The water alone with the carbon dioxide gas driven out of it is not a solvent for calcium carbonate, and the latter is precipitated.

Feldspars of various sorts are usually distributed throughout the drift deposits. These also are slowly decomposed by carbonated waters thereby adding to the water, compounds of sodium, potassium, iron and aluminum, as well as hydrated silica, which is also soluble. The general type of this reaction may be shown, thus:

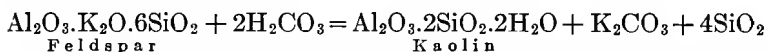

In this way complex or impure rocks may, upon their decomposition, yield small quantities not only of lime and magnesium in solution as bicarbonates, but also iron in a bicarbonate form, as well as salts of sodium, potassium, and silicic acid. This result would be more readily understood if we were to enter into a study of the composition of the drift, especially of a region like the Mississippi Valley where the glacial clay has a very considerable admixture of ground rock such as feldspar, hornblende, mica, dolomite, etc. Moreover, since all drift formation has been deposited in contact with or by means of sea water, we expect a greater or less amount of mineral substances to be present due to such water; namely, sodium chloride, calcium sulphate, etc.

Solubility of Gypsum.—We are familiar with the solubility of sodium chloride, but calcium sulphate or gypsum is also soluble,

although to a less degree, and this without the aid of carbon dioxide. Its solubility, for example, may be illustrated by the following table:

TABLE XV.—SOLUBILITY OF GYPSUM
($\text{CaSO}_4 + 2\text{H}_2\text{O}$)

1 part dissolves in about	500 parts of water at ordinary temperature
1 part dissolves in about	1,200 parts of water at 250°F.
1 part dissolves in about	1,800 parts of water at 300°F.
1 part dissolves in about	3,800 parts of water at 325°F.

From the above facts it may be readily understood how the mineral constituents come to be dissolved in all underground waters. The kind, amount, and properties of these substances indicate directly the behavior of a water when used for boiler purposes. Almost without exception their presence is objectionable for reasons which will be evident from the following discussion.

Effects of Impurities.—The difficulties which attend the use of water in the generation of steam are three in number:

First, *mineral scale* is formed upon the shell, flues, and sheets; second, *foaming* or *priming* may occur; and, third, the water may have *corrosive action* and weaken the metal of which the boiler is composed.

The constituents of a water, therefore, naturally group themselves under these three heads:

1. Scaling ingredients.
2. Foaming ingredients.
3. Corrosive ingredients.

Scaling Ingredients.—Scaling ingredients are always considered as including silica and any combination of iron, aluminum, calcium, and magnesium. Since the formation of scale is the most common and perhaps the most evident difficulty which accompanies the use of a boiler, it has sometimes been made the basis of a classification for waters. At a meeting of the American Association of Railway Chemists at Buffalo, N. Y., May 24, 1887, a schedule of classification was adopted. Waters containing varying quantities of scaling material per U. S. gallon were graded as in the table below:

TABLE XVI.—CLASSIFICATION OF WATERS BY THE ASSOCIATION OF RAILWAY CHEMISTS

Below 8 grains.....	Very good
8 to 15 grains.....	Good
15 to 20 grains.....	Fair
20 to 30 grains.....	Poor
30 to 40 grains.....	Bad
Over 40 grains.....	Very bad

In this table the first line was added by the Chicago, Burlington & Quincy Railway to fit the case of Lake Michigan water, which has approximately 8 grains or less per gallon.

This classification is relative only, since a wider study of the subject has indicated the necessity of taking into account the kind of scale which would form and the other ingredients in addition to those which produce scale. The scale when formed, may be dense and flint-like or open and porous. These characteristics result from the various types of mineral content involved. In general, a hard, flinty scale is due to the presence of calcium or magnesium sulfates; while, in waters in which only the carbonates of these substances are present, the scale will be more open and friable. Indeed, a very large number of waters are met with where only carbonate hardness is present. In these cases the major part of the incrusting solids appears as mud or sludge. For these and other reasons the above classification has not met the needs of the case and has, indeed, not been adopted to any considerable extent. A much more practical classification would take account of all of the various constituents and the characteristics for which they are responsible. The method of classification devised by the Chicago, Burlington & Quincy Railroad is based on the amount of these various constituents. Since the full meaning of the same can be better understood later, it is reproduced at the end of this chapter.

Effect of Scale.—Boiler scale is a disadvantage for the reason that: First, it retards the transmission of heat; second, it promotes the formation of a high temperature in the plates, with a possibility of softening the same; third, the sudden rupture or opening up of the scale may admit water to the highly heated metal, forming hydrogen and oxygen; fourth, the higher temperature of the steel thus maintained, even though not reaching

the danger point, promotes the absorption of sulphur and oxygen and thus causes a deterioration of the metal. Doubtless the chief item in this list, by reason of its continuous and total aggregate effect, is the decrease of heat conductivity, requiring a larger amount of fuel. Authorities differ as to the extent of loss. A conservative estimate would place the loss of fuel at 10 per cent for each $\frac{1}{16}$ in. in thickness of the scale. The difficulties attending the estimation of the fuel loss are great, and it is to be expected that a rather wide range of results is found in the published data.¹

A test of the steaming efficiency, made upon an Illinois Central locomotive by the University of Illinois in 1898 and described in the *Railway Gazette* for the following year, indicated a loss of heat, with a scale averaging $\frac{3}{8}$ in. in thickness, amounting to 9.6 per cent. The same engine was tested before overhauling at the shops and was returned after cleaning for the comparative test. An interesting computation was made on the same road at a much earlier date, in which the performance sheets for 120 locomotives were taken with reference to the consumption of coal before overhauling, and these results were compared with the coal consumed for the 3 months immediately following such a cleaning, with an average for the 120 engines of almost exactly 10 per cent in favor of the scale-free condition. Many other tests have subsequently been made more or less confirmatory of these results.

Foaming Ingredients.—The non-scaling or foaming ingredients are considered to be the salts of the alkalis, such as sodium chloride, sodium sulphate, sodium carbonate, potassium chloride, potassium sulphate, potassium carbonate, etc. Other conditions contribute to the tendency of water to foam, such as the presence of organic matter, especially such substances as may form soap. The presence of finely divided solids in suspension is also a contributing cause.

¹ BRECKENRIDGE, L. P., The effect of scale on the evaporation of a locomotive boiler: *R. R. Gazette*, vol. 31, new series, p. 60, 1899.

Am. Ry. Eng. Assn., 1914, p. 692: “. it is concluded that the saving of \$977 per locomotive represents 7 cents per pound of excess scaling matter entering the boiler.”

Univ. of Ill., Eng. Exp. Sta., *Bull.* 11.

Am. Ry. Eng. and Maint. of Way Assn., p. 41, etc., Jan. 1907.

The objections against foaming may be stated as follows: First, the rising of the water in the gage glass or blowoff cocks makes it difficult, if not impossible, to know the height of the water in the boiler; second, the discharge of wet steam or of steam carrying a considerable quantity of water is exceedingly wasteful of heat and makes it difficult to keep up the steam pressure; third, there is danger of large quantities of water getting into the cylinders where, by reason of its incompressibility and inability to pass quickly out of the ports, a cylinder head may thereby be blown off; and, fourth, the grit carried along with the water promotes the cutting of the walls of the cylinders and valve seats, thus making a re-boring of the cylinders necessary.

Concerning the causes which promote foaming, they are not so easy to define or classify as in the case of scaling, and they do not always relate directly to the character of the dissolved mineral substance. The tendency to foam varies greatly, for example, with the two general types of boilers employed, those used for stationary purposes, and the locomotive type. It might be said, indeed, that to the above mentioned conditions of the water might be added the nature of the spaces in which the generation of steam takes place. A network of staybolts and braces in a steaming space of small volume at best will be more conducive to foaming than the opposite conditions. The structure and steaming capacity of the locomotive, therefore, greatly increase the tendency of this type of boiler to foam. Tests on numerous railroads pretty generally agree upon the following facts concerning the foaming in locomotives. When a density of the water due to the presence of alkali sulphate or chloride reaches approximately 100 grains to the gallon, foaming is apt to occur, especially when the engine is put under heavy work. This means that in the raw water, before condensation has been carried on, a content of 25 grains per gallon would reach the foaming stage when three or four tankfuls had been taken into the boiler. However, a wide variation is due to the type of foaming ingredients, since a less amount of alkali salt will cause foaming where part of the substance is alkali carbonate, Na_2CO_3 , or soda ash. Where much organic matter also is present, a still less amount of free alkali will cause foaming. Indeed, cases have been met with where 15 to 25 grains per gallon of alkali salts have produced

foaming, when one-half, for example, of such salts were in the form of alkali carbonates, accompanied by a very considerable amount of organic matter. Foaming in stationary boilers would scarcely be caused by double the amount mentioned above.

Corrosive Ingredients.—Much disagreement exists regarding the causes of corrosion. Certain conditions will produce galvanic action between different metals used in construction, or even between different parts though made of the same metal, and this action eats away the metallic surfaces. Flaws, cinder scales, oxide nodules, etc., will, probably for a similar reason, produce pitting. Along sharp angles of construction, where the metal has been put under strain, corrosion will frequently occur. Carbonic acid gas or oxygen, when dissolved in water, are solvents for iron. Of course, the heat soon drives these gases out of the water, but corrosion in the vicinity of the feed inlet may be due to this cause. Some waters percolate through culm heaps or coal mine refuse or drainage and have produced in them free sulphuric acid from the oxidation of iron pyrites, or they may take up sulphate of iron or aluminium, all of which chemicals render a water positively and vigorously corroding.

Nitrates are seldom encountered, but, when present in any considerable amount, are strongly corroding. Calcium and magnesium chlorides are also strongly corroding. But, after all, it may be noted that many conditions can exist to neutralize the corrosiveness of a water. For instance, there may be formed a hard, dense scale which will effectually protect the iron. In this case, however, we would expect to see some tendency toward corrosion and pitting under the scale.

If, now, we attempt to classify waters according to the mineral constituents above outlined, we would have:

Classification. Class I.—This class includes such waters as have present free sodium carbonate or more than enough sodium to unite with the sulphate, chloride, and nitrate radicals or ions. There would be left, therefore, only carbon dioxide, CO_2 , to unite with the remaining sodium and also the calcium, magnesium, and iron. Such waters have only *temporary hardness*, there being no sulphates of calcium or magnesium. Upon boiling or using in the steam boiler, only a sludge forms instead of scale. The car-

bonates are all in the bicarbonate form and, hence, are stable in the cold, but decompose upon heating. Waters of this class are very widely distributed throughout the drift region, and the source is usually from deep wells.

Class II.—The waters of this class contain calcium or magnesium sulphate as well as bicarbonates, but not the chlorides of these elements. They have, therefore, permanent hardness and form a hard, flinty scale. Such waters are usual in surface supplies and in most shallow wells.

Class III.—This includes such waters as contain corroding salts or free acid in solution, such as the chlorides or nitrates of magnesium or calcium, the sulphate of iron or free sulphuric acid. Such waters are infrequent but, because of their corroding character, should be recognized when met with.

The Chemical Treatment of Boiler Waters.—From what has preceded it will be readily understood that the treatment of boiler waters must follow closely along the line of the chemical character of dissolved ingredients, with a view also to the properties which various ingredients impart to the water. In the first instance, it must be remembered that all natural water is strongly impregnated with carbon dioxide. We should recall again the fact that the presence of this gas in the water has furnished a solvent condition which has resulted in the formation of bicarbonates, especially of lime, magnesium, and iron.

In 1766, Cavendish announced the discovery that lime water added to certain hard waters would soften them, but the practical application of the principle was not made until 1841 when Dr. Thomas Clark, of Aberdeen, Scotland, obtained patents covering both the process and the apparatus employed. Clark's process has now mainly historic interest. It was ineffective on waters with sulphate or permanent hardness. While his methods seem crude in comparison with present-day processes, certain features have attained a permanent place in boiler-water literature. One is the use of lime and another is the use of a standard soap solution for measuring the total hardness in degrees, each degree representing one grain per Imperial gallon of soap-destroying material. This is known as Clark's scale of hardness. Numerous other methods are in vogue for indicating hardness of water. The table under "Standards for indicating degrees of

hardness," page 132, will be helpful in showing their relative values.

It is at once evident that there are two general types—Class I and Class II as referred to above under "Classification" which have material in solution of two different characteristics requiring two different processes when softening methods are involved.

Because of the fact that the compounds of the first group of substances are easily decomposed by heat and thus discharged from solution, we have a subdivision of scaling ingredients into:

I. Those which are designated as constituting temporary hardness, and

II. Those which constitute permanent hardness of water.

The first division is present in all waters and includes the larger part of the scaling matter; the latter is variable in amount and frequently absent, so far as the scaling constituents are concerned. These two general divisions or types of scaling material must be borne in mind, because they form the basis of all practical methods for water treatment, indeed, each division represents a process or a method which must be followed for the removal of these substances. This may be more clearly illustrated by the following outline:

TABLE XVII.—SCALING MATTER AND TREATMENT

Scaling matter is principally composed of	{	Division I. Bicarbonates as:	{	"Excess" CO ₂	{	For this division use	{	CaCO ₃ + 2H ₂ O
		as:		CaH ₂ (CO ₃) ₂ MgH ₂ (CO ₃) ₂ FeH ₂ (CO ₃) ₂		Ca(OH) ₂		CaCO ₃ + CaCO ₃ + 2H ₂ O Mg(OH) ₂ + CaCO ₃ + 2H ₂ O FeCO ₃ ¹ + CaCO ₃ + 2H ₂ O
		Division II. Sulphates as:		MgSO ₄ CaSO ₄ FeSO ₄		For this division use Na ₂ CO ₃ .		MgCO ₃ + Na ₂ SO ₄ CaCO ₃ + Na ₂ SO ₄ FeCO ₃ ¹ + Na ₂ SO ₄
						The results are		

It will be readily seen from this outline that the first division, carrying the bicarbonates, may be removed from the water either by heat or by the addition of some chemical which will absorb the "excess" and "bicarbonate" carbon dioxide. If we were to depend upon heat for this work, it would be a long process for the reason that ordinarily these bicarbonates are not completely

¹This substance quickly breaks down into Fe(OH)₃ thus:

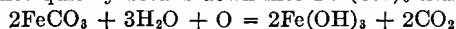

broken down except upon rather prolonged boiling, say for 15 or 20 min. or even $\frac{1}{2}$ hr., and this again would indicate the impracticability of such a method, because of the expense involved.

Treatment with Lime, $\text{Ca}(\text{OH})_2$.—Since hydrated lime reacts at ordinary temperatures and, moreover, is the least expensive of the possible reagents, it is made use of to react with the CO_2 of Division I of Table XVIII.

In measuring the amount of $\text{Ca}(\text{OH})_2$ needed for treating a water, it must be borne in mind that the CO_2 dissolved as H_2CO_3 will react with the $\text{Ca}(\text{OH})_2$ the same as the bicarbonates. Hence, we have a series of reaction thus:

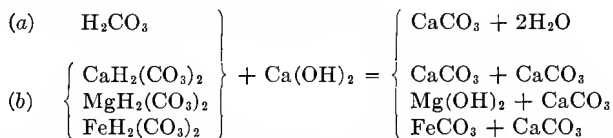

The total CO_2 to be thus taken care of is designated as (a) "excess" or "free" carbon dioxide, and (b) "half-bound" or one-half of the "bicarbonate" carbon dioxide. It is necessary to measure the amount of free carbon dioxide by titrating, say 200 cc. of the water with $\frac{N}{50} \text{Na}_2\text{CO}_3$, using phenolphthalein as indicator. Each cubic centimeter of this reagent, therefore, represents an equivalent of 0.001 gram in terms of CaCO_3 .¹

Therefore, five times the number required for 200 cc. of water would represent the equivalent in 1,000 cc. or 1 liter of water. This would represent milligrams per liter which is the same as parts per million. Parts per million multiplied by 0.0583 = grains per gallon.²

The "bicarbonate" carbon dioxide is determined by titrating a measured volume of the water with $\frac{N}{10}$ sulphuric acid, using

¹ The molecular weight of CaCO_3 is 100. This is a bivalent molecule, hence, the univalent or hydrogen equivalent would be 50 and the $\frac{N}{50}$ value would be 1 gram per 1000 cc. Hence, 1 cc. would have a CaCO_3 equivalent of 0.001 gram.

² One gallon weighs 58,330 grains hence $\frac{1}{1,000,000}$ of a gallon or 1 part per million weighs 0.0583 grains.

methyl orange as indicator (see p. 206, Part II). Each cubic centimeter of $\frac{N}{10}$ sulphuric acid is equivalent to 0.005 gram CaCO_3 . Therefore, if 200 cc. of water be titrated, each cubic centimeter of acid used corresponds to 0.025 grams, that is 25 mg. per liter or 25 parts per million bicarbonate carbon dioxide, *measured in terms of CaCO_3* .

The above estimation of the "free" and bicarbonate carbon dioxide would represent all of the conditions to be taken into consideration in connection with the lime treatment except for the slight irregularity in the behavior of one element. The magnesium carbonate, especially in the presence of other salts, is soluble to an extent which makes it advisable to carry the reaction one step further and provide for the formation of magnesium hydroxide which compares favorably as to insolubility with the calcium carbonate. This is effected by adding enough extra Ca(OH)_2 to correspond to the magnesium present. By direct determination, therefore, of the magnesium and the calculation of the same to the calcium carbonate equivalent, we have the necessary correction indicated for this element. By adding the calcium carbonate equivalent thus found to the factor as derived above by titration with $\frac{N}{10}$ sulphuric acid, we have a corrected calcium carbonate equivalent for the bicarbonate carbon dioxide plus the magnesium present.

Having thus determined the amount of "excess" and bicarbonate carbon dioxide plus the magnesium, in terms of CaCO_3 , the amount of reagent as CaO for the total CaCO_3 equivalent would be in the ratio of 56:100. To transfer to a unit of 1,000 gal., multiply values for 1 gal. by 1,000; and to transfer grains to pounds avoirdupois, divide by 7,000. Hence, $\frac{1}{7}$ of $\frac{56}{100}$ or 0.08 times the grains per gallon of total calcium carbonate equivalent represents the pounds of CaO reagent needed for each 1,000 gal. of water in removing or correcting for these ingredients.

In the case of common or commercial reagents used in water treatment, the impurities, of course, must be allowed for.

Where the lime is added in the form of a clear solution of Ca-

(OH)₂, the latter is dissolved to the point of saturation and this concentrated solution becomes the reagent.

The solubility of CaO is about 78 grains per gallon cold, (60°F.). Hence $\frac{1}{78}$ gal. of *lime water* contains 1 grain of CaO, and $\frac{7,000}{78}$ would represent the number of gallons necessary to hold 1 lb. of CaO in solution. Therefore,

$$\frac{7,000}{78} \times \frac{8}{100} \quad \text{or} \quad 7.18 \times \begin{array}{l} \text{The grains} \\ \text{per gallon} \\ \text{of CaCO}_3 = \\ \text{equivalent} \end{array} = \begin{array}{l} \text{Number of gallons satu-} \\ \text{rated lime water required} \\ \text{to remove the total calcium} \\ \text{carbonate equivalent in} \\ \text{1,000 gal. of water.} \end{array}$$

The solubility of CaO decreases as the temperature of the water increases. It should be remembered, also, that CaO slakes to Ca(OH)₂ and it is really the solubility of the latter compound which is involved. Usually, however, the reference is made to the solubility of CaO as the basis. Thus, by calculating from Lamy's tables (C. R., vol. 86, p. 333),

78 grains CaO will saturate 1 U. S. gallon at 60°F.
70 grains CaO will saturate 1 U. S. gallon at 86°F.
58 grains CaO will saturate 1 U. S. gallon at 112°F.
51 grains CaO will saturate 1 U. S. gallon at 140°F.
33 grains CaO will saturate 1 U. S. gallon at 212°F.

Recently the market has come to be supplied with pulverized dry lime in the hydrated form. To find the solubility by weight of this material, calculate the above amounts to the equivalent of Ca(OH)₂. Thus,

$$\begin{array}{ccccccc} 56 & : & 74 & :: & 78 & . & x \\ \text{CaO} & & \text{Ca(OH)}_2 & \text{gr. CaO} & & & \text{gr. Ca(OH)}_2 \end{array}$$

Whence, 78 grains CaO = 103 grains Ca(OH)₂, which would represent the solubility per gallon at 60°F. of pure material.

Treatment with Soda Ash, Na₂CO₃.—Of the substances sufficiently cheap to be available, sodium carbonate or "soda ash" is by far the best adapted for Division II of Table XVIII, or those ingredients causing the permanent hardness of the water. No reaction or change in solubility by heating can be effective, though many attempts to remove the sulphate by reason of the less solubility of calcium sulphate in hot water (as indicated in Table XV), have been attempted. With this class of substances, it is more effective to remove them as carbonates, but this must be

brought about by the addition of a soluble carbonate salt, the cheapest of which is sodium carbonate or "soda ash," Na_2CO_3 , as above indicated.

To measure the amount of "soda ash," Na_2CO_3 , necessary for the precipitation of the sulphates of magnesium, calcium, and iron or permanent hardness, read carefully Exercise IX on page 213 of Part II.

The reactions involved may be represented as follows:

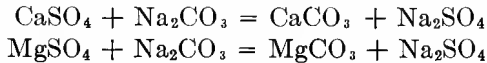

The amount of "soda ash" used up in this reaction is directly the measure of this substance to be used in treating the water. Thus, if 200 cc. of water were taken, then five times the number of cc. of $\frac{\text{N}}{10} \text{Na}_2\text{CO}_3 \times 0.0053$ would represent the weight in grams per liter of Na_2CO_3 required. This multiplied by 1,000 = milligrams per liter and this multiplied by 0.0583 would give the grains per gallon required directly in terms of "soda ash." Multiplying this by one-seventh would give the number of pounds needed per thousand gallons. Where magnesium salts are present as part of the permanent hardness, the MgCO_3 formed as indicated above is to be precipitated as $\text{Mg}(\text{OH})_2$, the same as under temporary hardness. Hence, all magnesium compounds call for an equivalent of $\text{Ca}(\text{OH})_2$ in addition to the primary reagent needed. This, however, is provided for in the method of analysis which determines all of the magnesium, whatever the form in which it is present; and the secondary reagent, $\text{Ca}(\text{OH})_2$, for its removal has been considered under the preceding topic; *viz.*, "Treatment with Lime." A double reaction is thus provided for magnesium, whether the combination be that of a bicarbonate, a sulphate, or a chloride.

Treatment with Coagulants.—Coagulants are more frequently employed for the removal of bacterial growths and the correcting of excessive turbidity. It is therefore a method of less frequent application in waters for boiler use. However, since there is a positive connection between suspended matter and foaming or priming in the generation of steam, the removal of such suspended matter may become important. Two methods may be employed.

First, the precipitated calcium carbonate and magnesium hydrate if considerable in amount, will act as a very effective medium for carrying down finely divided solids which otherwise would remain for a long time in suspension. For this reason it is of advantage where an intermittent process is employed to stir

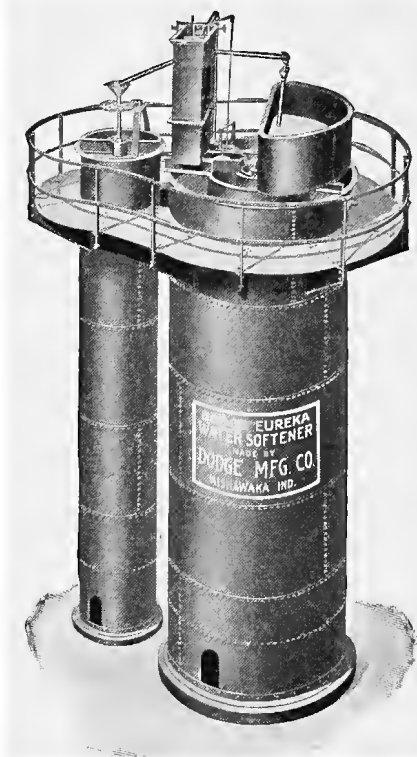

FIG. 23.—Eureka water softener, continuous system.¹ The description of the parts can be seen from the explanation accompanying Fig. 24.

throughout the mass of water the bottom sediment from previous reactions just before the addition of the fresh reagents. There will thus be accentuated the coagulating and settling effect of both the old and the new precipitates.

Second, if ferrous sulphate, FeSO_4 , or aluminum sulphate, $\text{Al}_2(\text{SO}_4)_3$, is added to the raw water in known amount and an

¹ Supplied by the Dodge Manufacturing Co., Mishawaka, Ind.

equivalent increase provided in making up the calcium hydroxide or soda ash, the result will be the formation of iron hydroxide $\text{Fe}(\text{OH})_2$, quickly changing to the red ferric hydroxide, $\text{Fe}(\text{OH})_3$, or the corresponding aluminum hydroxide, $\text{Al}(\text{OH})_3$. These

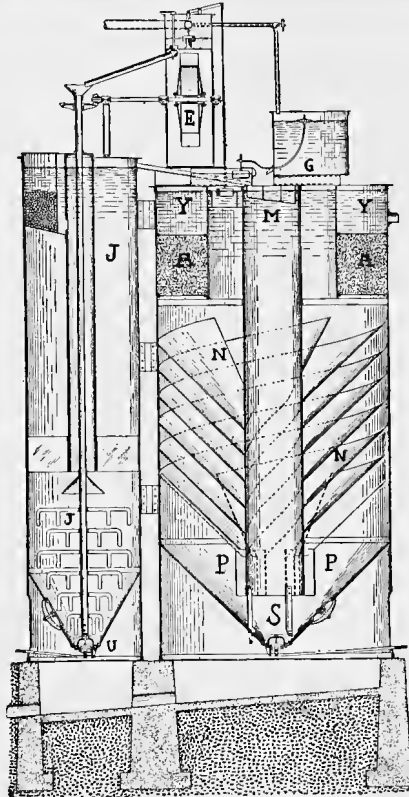

FIG. 24.—Continuous water purification apparatus.¹

- | | |
|--------------------------|-----------------------------|
| A—Wood fiber filter | M—Reaction chamber |
| E—Overshot water-wheel | N—Spiral accelerator plates |
| G—Soda ash solution tank | P—Sludge catchers |
| J—Lime saturating tank | Y—Treated water reservoir |
| S and U—Flushing valves | |

coagulants are exceedingly effective in carrying down suspended matter. The approximate amount usually employed is 1 grain per gallon or about 1 lb. per 5,000 gal. of water. The equivalent

¹ Supplied by the Dodge Manufacturing Co., Mishawaka, Ind.

quantity of reagent required over and above the calculated amount for the scaling matter present would be $\frac{5}{8}$ lb. of soda ash, Na_2CO_3 , or $\frac{1}{3}$ lb. of lime, CaO , or $\frac{2}{3}$ lb. of calcium hydroxide, $\text{Ca}(\text{OH})_2$, for each pound of ferrous sulphate employed.

Industrial Methods.—While in this discussion the reactions involved in the purification of water have been considered

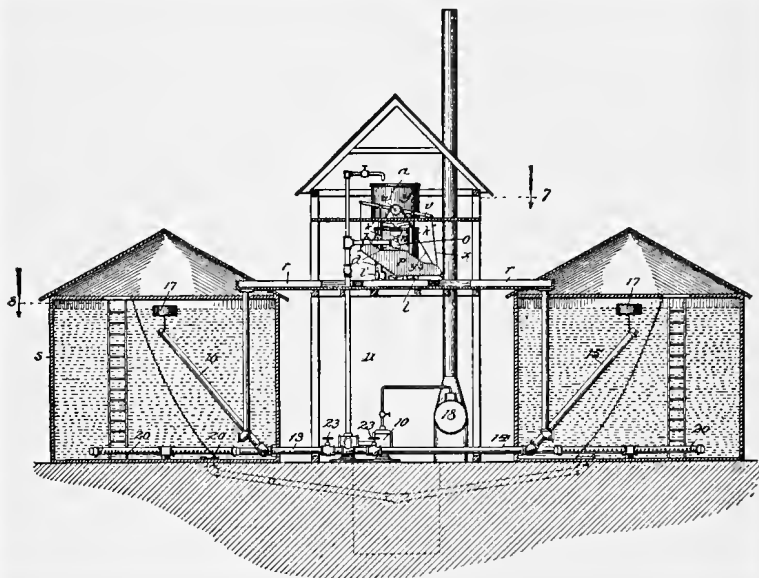

FIG. 25.—Intermittent purification system, as used by the Chicago and Northwestern Ry. Co.¹ The pump house is located between the two tanks. The raw water, together with the chemical mixture, is delivered into the tilting vessel, *p*, from which it is discharged to the right or left into the wooden box or trough, *r*, and, *r'*. These troughs are provided with shut-off gates, so that the treated water may be delivered entirely into one tank or the other.

separately and as two distinct processes, in practice they are combined into one operation; that is, the calculated amount of lime for treating, say, 1,000 gal. of raw water has incorporated with it the amount of soda ash as indicated by the sulphate or permanent hardness per 1,000 gal., and the two reagents thus combined are added directly to the water.

¹ Designed by G. M. Davidson, Chemist and Engineer of Tests, Chicago & Northwestern Ry. Co.

Very many mechanical devices for automatically measuring the correct amount of each reagent are in use, depending in the main upon the principle that a given weight or volume of the incoming raw water shall operate certain mechanical arrangements, whereby the proper amount of chemical is discharged into the water. The devices are of two general types—the continuous and the intermittent. In the continuous type the raw

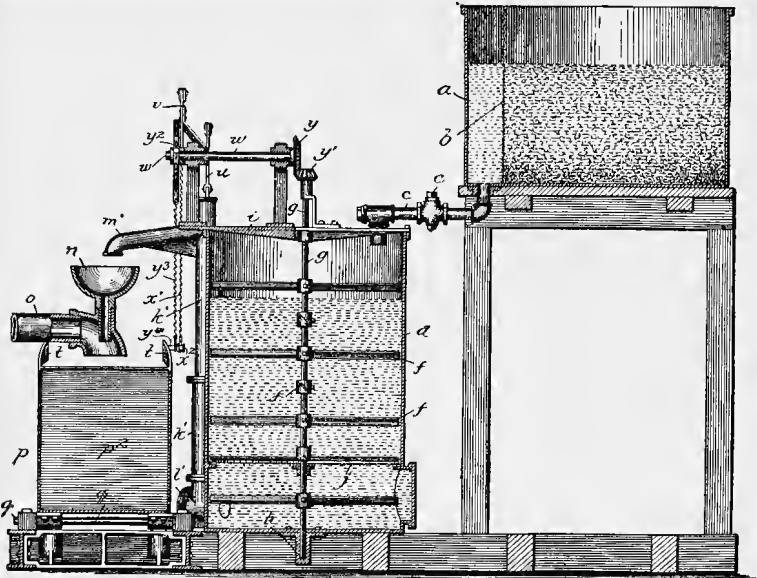

FIG. 26.—Chemical mixing and measuring device.¹ The chemical is delivered through the funnel, *n*, together with the raw water, passing through the pipe, *u*, into the tilting vessel, *p*.

water flows into the apparatus and is discharged in the purified form ready for use. In the intermittent type the raw water is made to flow through a mechanical measuring arrangement, whereby the chemicals in the proper proportion are added, after which the water is brought into a large settling tank for the time element to enter in for the accomplishing of the reaction involved and also the settling out of the precipitates. Both types are

¹ Designed by G. M. Davidson, Chemist and Engineer of Tests, Chicago & Northwestern Ry. Co.

effective, the essential point in any case being that the automatic devices for measuring the reagents be exact and unailing in their operation. Illustrations are given of representative devices for each type. They have been selected primarily with reference to their adaptability in the matter of illustrating the principles of water treatment as outlined in the text.

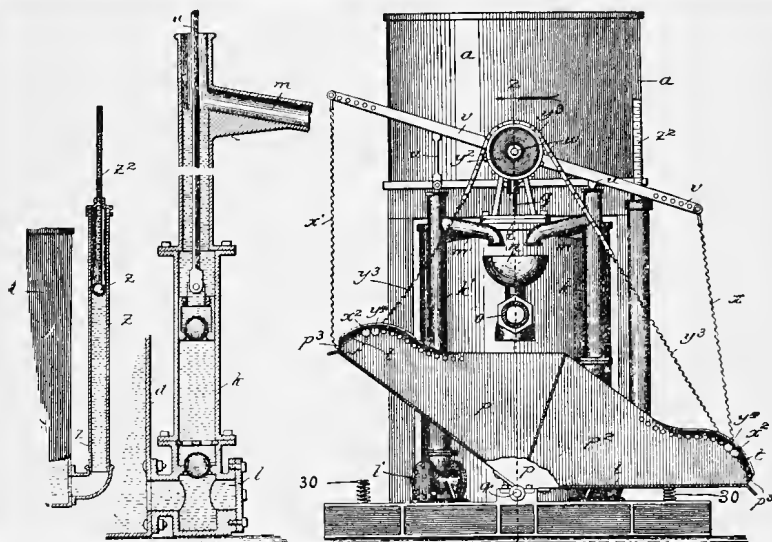

FIG. 27.—Chemical mixing and measuring device, front view.¹

Arguments are plentiful for the adoption of some form of water purification for practically every sort of industrial use. For domestic and laundry purposes the softening of the water supply by means of the soap employed is, theoretically at least, far more expensive than doing the same work with soda-ash and lime. The various railway systems for the most part make use of purification plants for their service waters. One company with 34 treating plants on its various lines shows a summary for 1915 as follows:²

¹ Designed by G. M. Davidson, Chemist and Engineer of Tests, Chicago & Northwestern Ry. Co.

² Communicated by R. C. BARDWELL, Chief Chemist, Missouri Pacific Ry., Kansas City.

Total consumption treated water, gallons.....	604,468,087
Total scaling material removed by treatment, pounds.....	1,816,837
Saving in fuel, repairs, etc., estimated at 7 cents per pound of incrustants removed.....	\$127,171.00
Cost of treatment, labor, chemicals, maintenance, plus 10 per cent. on investment.....	<u>26,017.00</u>
Total net saving.....	\$100,454.00
Cost of 34 treating plants.....	\$70,450.00

TABLE XVIII.—RATING OF BOILER WATERS

As made use of by the C. B. & Q. R. R., W. H. WICHORST, Engineer of Tests

Incrusting Rating

The figures represent parts per 100,000.

1. Very good—Water having sodium carbonate, and hardness less than 35.
2. Good —Water having sodium carbonate, and hardness greater than 35.
Water having sulphate hardness less than 5, or total hardness less than 20.
3. Fair —Water with sulphate hardness between 5 and 10, and total hardness less than 30, or total hardness between 20 and 30.
4. Bad —Water with sulphate hardness between 10 and 15, and total hardness less than 50, or total hardness between 30 and 50.
5. Very bad —Water with sulphate hardness greater than 15, or total hardness greater than 50.

Foaming Rating

- (A) Very good—Alkali salts less than 7.
- (B) Good —Alkali salts between 7 and 15.
- (C) Fair —Alkali salts between 15 and 25.
- (D) Bad —Alkali salts between 25 and 40.
- (E) Very bad —Alkali salts over 40.

Summary of Ratios.—In the preceding discussion the various scaling ingredients have all been reduced to the CaCO_3 equivalent, chiefly for convenience in making calculations for the amount of reagent needed in treatment. If, however, we have in hand the analysis of a water giving the hypothetical combination as the various ingredients are supposed to occur in the water, it will be found more convenient to make use of a table of factors, as given on p. 219. This, in the main, has been compiled from the *Report* of the Committee on Water Service of the American Railway Engineering and Maintenance of Way Association, embodied in their *Bulletin* No. 83, January, 1907. See also *The Hardness of Illinois Municipal Water Supplies*, by Dr. Bartow, *Proc. Illinois Society of Engineers and Surveyors*, 1909.

Standards for Indicating Degrees of Hardness.—The English degrees of hardness on Clark's scale as it is usually called, represent grains per Imperial gallon; that is, each degree is 1 part per 70,000. Hence, 1 degree of hardness by the Clark scale would be $\frac{70,000}{58,330}$ or 1.2 degrees per U. S. gallon.

It is usual in this country to refer hardness as well as the other values to parts per million, although the French unit is sometimes used, wherein the reference is to parts per 100,000.

TABLE XIX.—RELATIVE VALUES FOR DEGREES OF HARDNESS

	Grains per U. S. gallon	Grains per Imperial gallon	French unit or parts per 100,000	U. S. unit or parts per 1,000,000
1 part per 1,000,000	0.058	0.07	0.10	1.00
1 degree Clark's scale	1.20	1.00	1.43	14.30

Limits of Purification.—It should be borne in mind that at ordinary temperatures the precipitated material is soluble to the extent of 3 to 5 grains per gallon. Hence, this represents the approximate limit to which scaling matter can be removed. At higher temperatures the solubility, especially of the magnesium product, is greatly reduced. So that, if it were practicable to raise the temperature of the water for treatment 50°F., the residual scale forming material could be reduced to 1 or 1.5 grains per gallon.¹

Typical Waters and Their Treatment.—In the table below is given the composition of a number of typical waters from municipal supplies in Illinois, together with the calculated amounts of the reagents called for and the cost of the same calculated on the basis of lime at \$6.00 per ton and soda ash at \$6.00 per 100 lb.²

Zeolites.—Certain earthy compounds of the zeolitic type have the property of removing calcium and magnesium from water which is made to percolate through them. These compounds are hydrated double silicates of aluminium and a base which may be an alkali or an alkaline earth. These bases are readily inter-

¹ POWERS, W. A., "Water Softening," Chief Chemist, Santa Fe Railway.

² DR. BARTOW, From Hardness of municipal water supplies: *Proc. Ill. Soc. Eng. and Surv.*, 1909.

changeable, hence their adaptability to the water softening process. For example, a water carrying calcium bicarbonate in passing through such a compound with a sodium base will exchange one molecule of CaO for 2 molecules of NaHCO₃, thus,

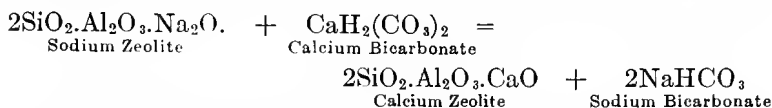

If the water contained calcium sulphate in solution, the reaction would take place in similar manner, yielding sodium sulphate, Na₂SO₄, to the water in place of the CaSO₄ originally present. When all of the sodium base has been removed, the activity of the zeolite ceases, but it may be regenerated by passing a salt brine through, which restores it to its original activity.

Artificial zeolites with the maximum capacity have been devised and are extensively used in water purification systems under the name of "Permutit."¹

This ability to interchange bases has been found to a greater or less degree in many natural deposits and doubtless is the most rational explanation for the very widely distributed waters of Class I, which are characterized by the presence of free sodium carbonate and temporary hardness only.

The first water of this type, doubtless, to be brought to the attention of chemists, resulted from an attempt in 1884 to sink a coal shaft at Urbana, Ill. At a depth of 160 ft., the shaft was abandoned on account of quicksand and excessive water. The water was made to serve as city supply for both Urbana and Champaign by putting down numerous driven wells with 8-in. casings. Two new wells have recently been put down with 24- and 30-in. casings respectively.

This initial example was made the subject of some interesting studies at the University of Illinois and the area supplying it was fairly well outlined.² Waters of this type are now known to exist and have been developed for use in many localities throughout the state. This is very well shown in Table XX, where 12

¹ BARRETT, J. F., and BARTOW, EDWARD, The use of Permutit in water softening: Ill. State Water Surv., *Bull.* 13, p. 307.

² PARR, S. W., The service waters of a railway system: *Jour. Am. Chem. Soc.*, vol. 28, p. 640, 1906.

TABLE XX.—TABLE SHOWING THE HARDNESS, AND THE AMOUNT OF TWENTY-EIGHT ILLI-

City, town and village	Class	Mineral content—parts per million							
		Iron	Res.	Na ₂ CO ₃	MgCl ₂	MgSO ₄	MgCO ₃	CaSO ₄	CaCO ₃
Amboy.....	II	1.4	450	25.8	118.4	211.7
Atlanta.....	I	8.4	464	68.6	146.8	210.4
Aurora.....	III	0.4	418	13.9	34.1	50.2	161.0
Beardstown.....	II	1.8	366	65.0	56.4	189.0
Belvidere.....	III	0.1	511	22.1	106.9	63.3	276.2
Bloomington.....	II	1.6	1,070	346.0	12.9	436.5
Byron.....	II	0.0	288	10.5	113.9	110.5
Cambridge.....	I	1.0	1,044	58.7	72.7	101.4
Canton.....	II	1,892	156.0	25.2	234.0
Carbondale.....	I	0.7	2,198	268.8	27.4	53.4
Carrollton.....	II	0.2	357	5.0	76.9	186.7
Chatsworth.....	I	0.5	617	168.9	69.6	195.4
Danville.....	II	0.1	485	44.5	108.9	210.8
Dwight.....	II	0.7	1,106	192.0	20.2	276.0
Elgin.....	I	0.5	342	17.0	91.0	196.0
Farmer City.....	I	1.0	730	225.7	89.0	168.4
Freeport.....	III	0.7	432	3.1	37.1	126.0	192.0
Galesburg.....	II	0.3	1,689	203.1	23.1	259.2
Harvey.....	II	tr.	1,448	251.1	352.6	171.7
Havana.....	III	0.0	202	1.2	27.3	28.0	100.9
Minonk.....	I	0.2	2,337	363.5	24.6	22.2
Normal.....	I	3.8	414	140.2	122.2	77.6
Ottawa.....	I	0.4	402	89.0	77.0	144.0
Polo.....	II	0.2	339	5.3	122.6	174.4
Rantoul.....	I	1.8	350	55.7	63.5	202.1
Springfield.....	II	1.1	370	53.4	66.1	182.4
Trlono.....	I	2.7	678	264.4	117.6	221.2
Urbana.....	I	1.8	392	46.2	118.4	180.7

of the 28 waters listed are seen to be of this type. Notice in each case the total absence of any of the constituents which form permanent hardness.

In his study of the Thanet sands and chalk deposits of the London basin, Thresh¹ concludes that the alkaline waters of that region result from the reactions occurring as a result of contact with that material which he shows to be zeolitic in character.

¹ THRESH, J. C., "The Examination of Waters and Water Supplies." 2d Ed., p. 368, 1913.

LIME AND SODA ASH REQUIRED TO SOFTEN THE WATER FURNISHED TO
NOIS MUNICIPALITIES

Soda ash			Lime			Chemicals	Remarks
Parts per million	Grains per gallon	Pounds per 1,000 gal.	Parts per million	Grains per gallon	Pounds per 1,000 gal.	Approximate cost per 1,000 gal.	
22.7	1.3	0.18	288.0	16.7	2.40	0.01560	160-ft. well
.....	349.3	20.2	2.90	0.01450	151-ft. well
45.4	2.6	0.37	181.0	10.5	1.50	0.01490	2,250-ft. well
57.2	3.3	0.47	211.2	12.3	1.75	0.01815	30- and 90-ft. wells
118.7	6.8	0.97	301.8	17.5	2.51	0.02195	1,800-ft. well
314.9	18.3	2.61	405.3	23.6	3.37	0.06905	Well No. 1, 60 ft.
9.2	0.5	0.07	218.2	12.7	1.81	0.02345	2,000-ft. well
.....	184.5	10.7	1.53	0.00765	1,380-ft. well
137.4	79.8	1.14	237.2	13.8	1.97	0.03265	1,646- and 2,042-ft.
.....	208.4	12.1	1.73	0.00865	410-ft. well
4.4	0.2	0.03	209.1	12.1	1.74	0.00930	Spring
.....	291.2	16.9	2.42	0.01210	1,285-ft. well
39.2	2.2	0.32	283.5	16.4	2.36	0.01820	
167.4	9.7	1.39	270.8	15.7	2.25	0.03905	136-ft. well
.....	230.7	13.4	1.91	0.00955	1,300-ft. well
.....	331.8	19.2	2.76	0.01380	176-ft. well
36.1	2.1	0.30	294.0	17.1	2.45	0.01825	Before filtration
178.9	10.3	1.48	270.4	15.7	2.25	0.04085	1,252-ft. well
495.9	28.8	4.12	213.1	12.4	1.77	0.09125	1,680-ft. well
25.3	1.4	0.21	107.1	6.2	0.89	0.00865	72-ft. well
.....	237.3	13.8	1.97	0.00985	1,850-ft. well
.....	280.0	16.3	2.33	0.01165	180-ft. well
.....	230.1	13.4	1.91	0.00955	1,200-ft. well
4.6	0.2	0.03	263.1	15.3	2.19	0.01155	1,200- and 2,100-ft. wells
.....	227.0	13.2	1.89	0.00945	120-ft. well
47.0	2.7	0.39	214.9	12.4	1.78	0.01670	
.....	420.0	24.4	3.50	0.01750	157-ft. well
.....	283.0	16.4	2.36	0.01180	160-ft. well

Numerous other regions in England are known to yield similar waters. This explanation is doubtless applicable also to the waters of the same type so frequently occurring in the drift deposits of the Mississippi Valley.

In the steam generator, the sodium carbonate of these natural waters hydrolysis to a very considerable extent, forming caustic soda, NaOH. After excessive concentration, leaks are likely to develop, where, due to further concentration, action between the caustic and the metal may result in an embrittlement and crack-

ing of the boiler plate in the immediate vicinity of these leaks.¹ A number of boiler explosions have been fairly well demonstrated to have resulted from such embrittling effect. However, in water treatment where a resulting excess alkalinity occurs there is formed also an equivalent of sodium sulphate which either because of its diluting or inhibiting effect, prevents the development of cracks. This also seems to be the status of waters artificially treated by zeolitic material.

¹ PARR, S. W., The embrittling action of sodium hydroxide on soft steel: Univ. of Ill. Eng. Exp. Sta., *Bull.* 94, 1917.

CHAPTER XVIII

LUBRICANTS

Introduction.—"Next to the conservation of the world's fuel supply there is probably no subject of greater importance in the manufacturing world than the control of waste power caused by imperfect lubrication and needless friction. . . . Archbutt has stated that of the 10,000,000 hp. in use in the United Kingdom of Great Britain considerably more than half this amount, 40 to 80 per cent of the fuel, is spent in overcoming friction, and that a considerable proportion of this power is wasted by imperfect or faulty lubrication."¹

Any substance made use of for the lessening of friction is called a lubricant. By its use the surfaces of sliding bodies are separated by a thin film which permits of easier movement than if the surfaces were in direct contact. Lubricants must, therefore, vary widely for the different kinds of work involved. For example, the "body" must be suited to the load. Working temperatures, both high and low, must be provided for. Oxidizing or gumming must not be a property of the material, and any tendency to corrode the metal surfaces must be absent.

Lubricants are derived from two main sources:

1. Oils of animal or vegetable origin.
2. Mineral oils.

Animal and Vegetable Oils.—All oils of this class are saponifiable. That is, they are compounds of fatty acids and glycerine. They decompose to a considerable extent on long standing, setting free the fatty acids. Many vegetable oils, as linseed oil, readily oxidize, forming a gumming substance. Only non-oxidizable oils are suitable for lubrication. Among vegetable oils the best-known illustrations are olive (sweet) oil and castor oil. Among animal oils, lard oil is perhaps the most common.

Mineral Oils.—These oils are derived from petroleum by distillation. They will not saponify, having no combination of

¹ MABERRY, C. F., *Jour. Ind. and Eng. Chem.*, vol. 2, p. 115, 1910.

fatty acids, and they will not oxidize to form "gumming" compounds.

Compounded Oils.—*The compounding of oils* is an attempt to render a certain oil more effective by mixing with another oil having slightly different properties. Thus, mineral oils may be said to be compounded with an animal oil to impart greater body or viscosity to the mixture; or, a vegetable oil with heavy body but too little fluidity, may be compounded with a mineral oil to improve its property in that direction. The peak of the viscosity effect produced by compounding a vegetable oil with a mineral oil is obtained with relatively low percentages of the vegetable oil, probably not over 2 or 3 per cent. Beyond this point the further addition of the vegetable oil may add an expense out of proportion to the benefit obtained. Mineral oils are often compounded with each other to produce certain desired properties. Greases are mixtures of heavy oil residues or vaseline-like substances with mineral soap, such as lime soap, to the extent of 30 to 40 per cent, thus giving a mixture of great body for heavy machinery, shafting, gears, etc. Finely pulverized mica or graphite is also similarly employed. Graphite especially lends itself to numerous combinations for the production of lubricants with specific properties. An interesting variation from the usual types is found in "Aquadag" and "Oildag" wherein the graphite is so minutely divided that it is possible by use of proper dispersoids to form permanent emulsions with both water and oil. This property suggested to Mr. Acheson, who developed the material, the designation of "Deflocculated Acheson Graphite;" hence the term, "Oildag," etc.

For high temperature service the problem becomes more difficult. An oil must be selected which will not volatilize at the high temperature employed. The principal tests in the examination of oils have for their purpose the development of these various properties, for example, the viscosity and body as shown by the viscosimeter and specific gravity, the flash point for high temperature use, acid or saponification number to show whether or not the oil is compounded with animal or vegetable material.

Because of their low cost and the ease with which they may be varied to meet the different conditions as to load, speed and temperature, petroleum and the products which may be derived

therefrom have come to predominate in the entire field of lubricants. Hydrocarbons of the general type, C_nH_{2n+2} or the paraffin series are probably best suited for lubrication purposes. However, because of the development of processes for distilling, cracking, and mixing it would be impossible to prescribe a chemical composition to conform to any specific type of carbon compounds. Doubtless some forms are more unstable than others and as a rule, in service at high temperatures as with automobiles, there is a tendency toward decomposition which is almost always accompanied by the formation of free, or perhaps more properly, colloidal carbon. Promoters of petroleum lubricants, however, who claim their special oils are without any carbon in their composition, have more zeal than chemical sense.

Testing.—The most common and the best established tests for indicating the suitability of an oil for lubricating purposes are the following:

- (a) Specific gravity.
- (b) Flash and fire test.
- (c) Viscosity.
- (d) Free acid.
- (e) Saponification number.
- (f) Maumené test.
- (g) Conradson test for carbonization.
- (h) Emulsification.

Specific gravity is directly an indication of the adaptability of the oil to the load. Light machinery requires a light oil. Heavy machinery should be supplied with an oil of not less than 0.885 sp. gr.

Flash and fire test are somewhat related to specific gravity but perhaps are of more value as indicating the care with which the lubricant was prepared. It is also an index of the adaptability of the oil to use where high temperatures are involved, as in the internal-combustion motor, the high-pressure steam engine and the steam turbine.

Viscosity is more directly related to specific gravity. It is due to the internal friction of the oil itself and must increase in amount with the load of the moving parts. No attempt is made to measure the viscosities of lubricants in terms of the viscosity of water as unity, that is, by factors which would repre-

sent specific viscosities. Special instruments have been designed which give arbitrary factors only. The end sought has been to devise a method which would give results which were consistent as to their relative values and which could be reproduced with a fair degree of accuracy. For this reason the viscosity number is meaningless unless accompanied with the name of the instrument by which it was determined.

Free acid results from carelessness in the refining process. It is therefore presumably sulphuric acid or sulphonic organic compounds formed from the unsaturated hydrocarbons. Either substance is strongly corroding.

Saponification serves as a means for indicating the amount of animal or vegetable oil used in compounding. This with the Maumené test may serve as a fairly reliable method for indicating the kind of fatty oil entering into the mixture.

The Conradson test is an attempt to measure the tendency of an oil to break down and deposit free carbon under ordinary lubricating conditions. It is based on the theory that upon evaporating a given oil to complete dryness, the residue of carbon remaining will furnish an index of the tendency of the oil to decompose or change its chemical composition in use.

Emulsification is a property especially to be considered in those systems of lubrication which circulate the oil under pressure and require that it be collected in a filtering and settling chamber for recirculating through the moving parts. It is a ready means for indicating a pure hydrocarbon oil as distinct from one carrying impurities, especially mixtures containing sulphonic residues or the saponified salts of organic acids such as calcium or magnesium soaps. After extended investigation into the significance of emulsification, the American Society for Testing Materials has included this test in its standards for indicating the purity or adaptability of lubricating oils for specific purposes. For some uses as with screw cutting machines, an emulsifying oil is desired. For forced feed systems a demulsifying oil is essential.

PART II

LABORATORY METHODS

CHAPTER XIX

THE PROXIMATE ANALYSIS OF COAL

Introduction.—The procedure as here outlined for the proximate analysis of coal follows substantially the final report on methods of analysis as adopted by the joint committee of the American Chemical Society and the American Society for Testing Materials.¹ The preliminary report of this committee² contains much detail of value relating to sources of error and general conditions to be observed in the procuring of accurate results. The final report is in a much more condensed form and is intended as a guide for every-day procedure in connection with coal contracts and inspection.

The Laboratory Sample.—The preparation of a working sample for the various analytical processes must be carried out with special reference to the chief considerations which govern the taking of the gross sample. For example, there must be maintained an even distribution of impurities throughout the sample. A certain ratio of size of particles to size of sample must be observed. If the gross sample as it comes to the laboratory is not over 5 lb. in amount the entire sample should be fine enough to pass a $\frac{1}{4}$ -in. screen. This means that the largest particle will have a dimension not greater than $\frac{2}{16}$ or $\frac{1}{8}$ in. Similarly the working sample of approximately 60 grams must be sufficiently fine to pass a 60-mesh sieve. With this reduction in size the tendency to segregate is increased and the opportunity for moisture changes is greatly augmented. This is an especially

¹ Report of Committee E-4, *Yearbook* Am. Soc. for Testing Mat., p. 596, June, 1915.

² *Jour. of Ind. and Eng. Chem.*, vol. 5, p. 517, 1913. Published also in *Proc. Am. Soc. for Testing Mat.*, vol. 14, p. 412, 1914.

important feature to keep in mind in working with Illinois coals which have an initial free moisture factor at the time of breaking out of the seam of from 5 to 15 per cent. These coals also absorb oxygen rapidly, especially when finely divided and at slightly elevated temperatures. This is the chief factor in deterioration and loss of heating value. The freshly prepared sample will be found to give higher values than an old one.

Moisture Loss on Air Drying.—Spread the “as-received” four-mesh sample to a depth of $\frac{1}{2}$ to $\frac{3}{4}$ in. on a weighed pan about 18 by 18 in. by $1\frac{1}{2}$ in. in depth. Weigh and air dry at room temperature or in a special drying oven through which a current of air is circulated and in which the temperature is maintained at 10 to 15°C. above that of the room. Weigh again after 12 to 24 hr. The moisture content should now be in approximate equilibrium with the moisture of the air. This will mean a moisture factor of from 3 to 5 per cent. It may be indicated by the fact that a continuation of the drying process will not show a loss of more than 0.1 per cent per hour. Note the loss of moisture on air-drying and calculate to per cent of the entire sample as received.

Working Sample.—Pass the air-dried sample entire at once after final weighing through a grinder of the coffee-mill type set to grind to about 20-mesh. Immediately after passing through the grinder, mix and riffle down to about 500 grams and transfer to a porcelain jar of an Abbé ball mill. The jar should be not over one-third full of pebbles and the coal sufficient in amount to have a partial cushioning effect so the pebbles will not strike too harshly upon the wall of the jar. A measurable increase in ash may result from abrasion of the jar. The coal should be pulverized to 60 mesh which will be complete for bituminous coals in about $\frac{1}{2}$ hr. The jar should turn at about 60 r.p.m. Separate the pebbles on a coarse sieve, mix and riffle the coal to a laboratory working sample of about 60 grams, all of which should pass a 60-mesh sieve. The sample is put in a 4-oz. bottle and closed with rubber stopper. The time occupied from the opening of the jar to the final enclosing of the sample should not be over 2 or 3 min.

Moisture in the Laboratory Sample.—Determine the moisture on the 60-mesh working sample, by weighing out 1 gram in a

glass capsule and drying with the cover off at 104 to 110°C. for 1 hr. Replace the cover, cool in the desiccator and weigh. The loss of weight is the amount of water in the sample. Save for ash determination. This sample is used for all of the analytical determinations. Calculate each value except the moisture factor to the dry basis.

Total Moisture (a).—The value for total moisture on the sample “as-received” is obtained by combining the loss on air drying with the moisture factor found on the air-dry sample as just described. These two factors cannot be added of course until brought to the same basis of reference. Calculate the moisture found in the air dry sample to the percentage it would be of the original coal “as received” and add to the loss on air drying. This will give the total moisture percentage. Special attention should be given to methods of calculation discussed under “Calculations” at the end of the chapter.

Total Moisture (b).—Another method whereby the total “as-received” moisture is obtained directly and which also has certain advantages and is probably in more general use is as follows: Immediately after passing the 5-lb. gross sample through the coffee-mill grinder for reduction to 10- to 20-mesh size, it is spread out in a shallow pan and by means of a spoon a 60-gram sample is taken from various parts. This is placed without sieving in a rubber-stoppered bottle and labeled “For Total Moisture.” Weigh 5 grams into a shallow aluminum dish with suitable glass cover and heat with the cover off for $1\frac{1}{2}$ hr. at 104 to 110°C. Cover and cool in a desiccator over concentrated sulfuric acid sp. gr. 1.84. The loss in weight calculated to per cent. represents the total moisture of the coal “as-received.”

The main portion of the sample is air-dried in a shallow pan as described under that paragraph but without regard to moisture loss. When the moisture content is reduced to 3 to 5 per cent, the sample is thoroughly mixed and reduced by riffing to about 120 grams. It is then pulverized by any suitable method to 60-mesh, and the moisture determined by oven drying at 104 to 110°C. as described under “Moisture in the Laboratory Sample.”

Ash (a).—Transfer the 1 gram of coal remaining in the glass capsule from the moisture determination to a shallow porcelain ashing dish. Place on a triangle 2 or 3 in. above a Bunsen flame.

It can be left in this condition without attention for 15 or 20 min., when most of the carbonaceous matter will have been burned off. Lower the ashing dish to within $\frac{1}{4}$ or $\frac{1}{2}$ in. of the flame and leave without attention for an equal length of time. Occasional stirring with a platinum or Irium wire will facilitate the oxidation. Finally place the capsule in a muffle maintained at a dull or cherry red temperature at 700 to 750°C. Ten minutes in the muffle should be ample for burning off the last traces of carbon. If special ashing dishes and a muffle are not available, a porcelain crucible and No. 5 Meker burner may be used but special care should be given to the temperature employed and sufficient time allowed with occasional stirring to insure complete burning out of all carbonaceous matter. Cool in the desiccator and weigh. Subtract the weight of the crucible and compute the weight of the ash to percentage of air dry coal.

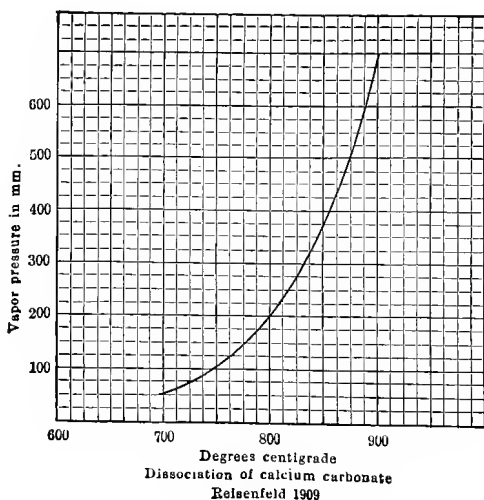

FIG. 28.

Ash (b).—It, occasionally occurs that Illinois coals are met with, having a percentage of CaCO_3 , which makes it advisable in careful work, especially where unit coal values are involved, to modify the usual method for the determination of ash. When the CO_2 value, for example, exceeds 1 per cent, or when the

calcite is in excess of about 2 per cent, these modifications should be observed. The reason is obvious. The combination of FeS_2 and CaCO_3 in the process of ashing produce Fe_2O_3 and CaS . The latter, however, slowly oxidizes to CaSO_4 . It is the uncertainty as to the completeness of this change which makes it advisable to proceed as follows:

After the preliminary burning off of the carbon and cooling, the ash is moistened with a few drops of sulfuric acid (diluted 1:1) and after careful application of heat to avoid spurting, is heated to 700 to 750°C. and retained at that temperature for

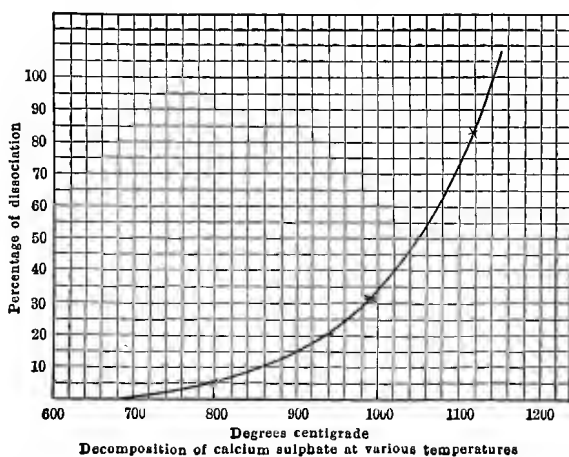

FIG. 29.

3 to 5 min. Cool in a desiccator and weigh. Three times the equivalent of carbon present as CaCO_3 is subtracted from the ash as weighed in order to restore the weight of the CaSO_4 formed to the equivalent of CaCO_3 . That is,

$$\begin{aligned} \text{SO}_3 &= 80 \\ 3\text{C} &= 36 \\ 80 - 36 &= 44, \text{CO}_2 \text{ equivalent} \end{aligned}$$

By reference to the dissociation temperatures at normal pressure, Fig. 28, for calcium carbonate it is evident that it would be futile to attempt to ash a high calcite coal at a temperature sufficiently low to avoid decomposition of the CaCO_3 . By

reference to Fig. 29, however, it is evident that a complete transformation of the CaCO_3 to CaSO_4 would permit the use of a temperature of 700° without loss.¹

Volatile Matter, Official Method.—The official method for determining the volatile matter in coal as indicated by the joint committee on coal analysis in the *Journal of Industrial and Engineering Chemistry*² prescribes the use of a platinum crucible with capsule cover fitting inside of the crucible, that is, telescoping $\frac{1}{8}$ to $\frac{1}{4}$ in., instead of an ordinary cover resting on the upper edge. The crucible with 1 gram of coal is placed in a muffle maintained at 950°C . ($\pm 20^\circ\text{C}$.) A vertical electrically heated muffle is easy of construction and very satisfactory for this work. On account of the variation in pressure and heating value of city gas it is difficult to obtain consistent results with the Bunsen or Meker burners. A muffle heated by gas and maintained at the proper temperature is much to be preferred to heating by the direct flame. On account of the expense of platinum, the use of an Illium crucible may be substituted in class work as indicated below.

It is to be noted that any method which retards the transmission of heat to the coal will result in a lower indicated amount for volatile matter, and a correspondingly higher percentage for fixed carbon. The Illium alloy should give the same values as when using platinum. In the absence of a suitable muffle it may be possible to make use of the flame of a large Meker burner. By means of a thermocouple it should be determined that the flame temperature of the gas used is well above 900°C . and a burner used of sufficient size to completely envelop the Illium crucible and capsule cover. This is fairly well accomplished by use of the No. 5 Meker burner. Where porcelain crucibles are the only ones available the discrepancies from the official values are apt to be large. Fairly satisfactory results may be obtained, however, by use of a No. 5 Meker burner and accumulating an advance heat supply as indicated in the next paragraph.

Volatile Matter, Porcelain Crucible Method.—Select a porcelain crucible with well-fitting cover, ignite, with cover, in the flame of a No 5 Meker burner to a dull-red heat, cool in the

¹ Ill. State Geol. Surv. Coop., *Bull.* 3, pp. 30–36.

² Vol. 5, p. 522, 1913.

desiccator and weigh. Place a nichrome triangle over the burner and over the triangle place an inverted 20-gram assay crucible with the bottom ground off, exposing a hole approximately 1 in. in diameter. When this apparatus is heated to as high a temperature as possible, remove the inverted crucible, put in place the porcelain crucible, with cover on, containing the 1 gram of air-dry coal, and restore at once the prepared assay crucible. Continue the heating for 7 min. and at the end of the period turn off the flame and remove the assay crucible but do not disturb the cover of the porcelain crucible until the same has been reduced below a red heat. Transfer to a desiccator, cool and weigh with the cover. The loss in weight minus the moisture present is the weight of volatile matter.

Fixed Carbon.—The sum of the percentages for moisture, (on the air-dry or working sample) ash, and volatile matter, subtracted from 100, will leave as a remainder the percentage of fixed carbon in the air-dry coal.

Calculations.—A type of computation is constantly employed in connection with fuel analysis, which, while exceedingly elementary, seems not to have been encountered by the average student in his public school work. Or possibly these simple arithmetical concepts, once familiar, have been forgotten because of the lack of even occasional contact. It is urged that the student revive his acquaintance with them to the point of genuine familiarity.

The working sample of coal which is used in all of the analytical processes has been brought into approximate equilibrium with the air so that its content of moisture will not appreciably change during the process of weighing out the amount to be taken for each determination. The preparing of this air-dry sample is therefore for the purpose of securing greater accuracy in weighing and is a matter of particular concern to the chemist only. The results obtained on that unusual or specific sample are of use to no one else and should not be reported in that form. They must be calculated either to the dry, that is the "moisture free," basis, or to the wet, that is the "as-received" basis, or more commonly, both sets of values are included in the report.

To transfer values obtained on the air-dry sample to the dry basis, the moisture factor is eliminated and the resulting values

total 100 per cent. Each value obtained on the air-dry basis therefore is divided by 1 minus the content of moisture.

The values obtained on the air-dry sample contain a moisture factor and total 100 per cent. To transfer them to the "as-received" basis there is to be restored the moisture lost on air-drying. The resulting values, including all the moisture, must total 100 per cent. The new values are computed therefore by multiplying the air-dry values by 1 minus the loss on air drying. Note, however, that the sum will not equal 100 per cent unless that process is applied to the moisture factor of the air-dry material and this value combined with the moisture loss on air drying.

It may be that the moisture loss on air drying has not been obtained but the somewhat simpler method has been followed of taking a special sample for total moisture. In this case calculate the air dry values to the dry basis and multiply these values by 1 minus the total moisture found in the "as-received" sample.

The reasons for these various processes should be clearly evident to the student. A simple formula can then be developed as a working convenience. Note that the general principle is involved in many other connections. For example, the corrected ash as well as the moisture are eliminated in deriving the values for unit coal where the only item wanted is the heat value to be transferred from the "wet" to the "unit-coal" basis.

CHAPTER XX

CALORIMETRY USING SODIUM PEROXIDE

General Statement.—The calorimeter should be placed on a good, firm desk in a room where fluctuations of temperature may be avoided. The general arrangement of parts is shown in Fig. 30. However, it is better to remove the can from the instrument

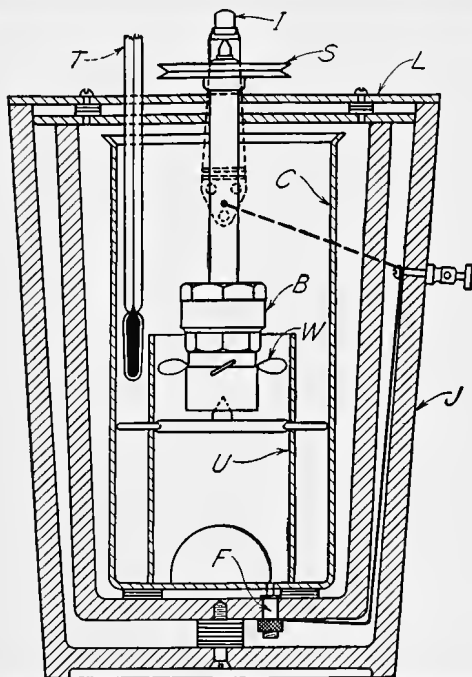

FIG. 30.—Parr peroxide calorimeter, showing details of construction.

for filling with water. The outside of the can should be dry, and no water should be allowed to spill over into the air spaces of the insulating vessels.

Exactly 2 liters of water (preferably distilled) are used, and

it should have a temperature of 2 or 3°F. below that of the room. The thermometer, T , should extend a little over half way to the bottom of the can. The pulley, S , is connected by a light, flexible cord with a small electric or water motor. Stirring is effected by the spring clips with turbine wings, W , placed on the bell body. The pulley, S , must be made to revolve at a rather brisk rate. About 150 r.p.m., uniformly maintained, will insure a complete equalization of temperature throughout the water. The pulley should turn to the right or as the hands of a watch.

Because of the extended use of the peroxide calorimeter by engineers in connection with the checking of coal deliveries, etc., these instruments are ordinarily supplied with thermometers graduated in degrees Fahrenheit. Results are thus given directly in B.t.u. In this discussion concerning the use of the peroxide calorimeter, therefore, that type of thermometer is assumed to be the one used unless otherwise indicated.

The Fuel Sample.—If the amount of moisture in the air-dried coal is less than 1 or 2 per cent, no drying in the oven is necessary for the determination of calorific value. One-half gram of air-dried coal is used and the detailed directions should be followed as given below.

Concerning the amount of moisture permissible in the fuel sample, it has been indicated¹ that the temperature rise in the apparatus as used, due to the absorption by the chemical, Na_2O_2 , of 1 gram of water is 0.663°C. In a $\frac{1}{2}$ -gram sample therefore, 2 per cent of moisture would represent 0.01 gram of water which if allowed to combine with the Na_2O_2 and if all the heat generated by that absorption were included in the calorimeter process, that amount of moisture would produce a rise of $0.01 \times 0.663 = 0.0066^\circ\text{C}$. This temperature rise would then cause an error of $0.0066 \times 3,100 = 20$ cal., which will give sufficient reason for avoiding the use of a coal with a high percentage of moisture. The error for 2 per cent of moisture would be less than the calculated amount, due to dissipation of the heat of absorption before the thermometric readings were taken, but the possibility of an appreciable error is easily guarded against.

¹ Constants of the Parr calorimeter, *Jour. Am. Chem. Soc.*, vol. 29, p. 1616, 1907.

The Chemical: Sodium Peroxide Na_2O_2 .—It is absolutely necessary that the chemical employed (sodium peroxide) be kept free from contamination. It has special avidity for moisture, and the glass jar with lever fastener, as shown in Fig. 31, has been found best adapted as a container for this material. The sodium peroxide is furnished in small sealed tins, and the entire contents of a can, upon opening, should be transferred completely to the jar. The half-pound tins will usually be found the most convenient size to use. In any event, the glass jar should be of sufficient size to permit of the complete emptying of the container. Commercial sodium peroxide or material that has been much exposed to the air so that any considerable amount of moisture has been absorbed, will give variable and uncertain results.

The Accelerator: Potassium Chlorate, $KClO_3$.—In order to secure a combustion that shall be uniformly complete, it has been found desirable to use an accelerator for the purpose of increasing or intensifying the oxidizing effect of the sodium peroxide. While numerous chemical mixtures have been tried, a very extended experience has made it evident that potassium chlorate is best adapted for this purpose. The amount needed for each charge is weighed out in the same manner as for coal. One gram is the weight taken for fuel of all types.

Making Up the Charge.—See that the floating bottom is in place at the lower end of the bell body as shown in Fig. 32. The inner surfaces should be dry so that the fusion cup, when put in place, will be surrounded by an air space with no film of water present. The fusion cup also should be *thoroughly dry* inside before adding the charge. It is well to dry it over a radiator or hot plate, though it should, of course, be cooled for filling. Add to the fusion cup, not assembled, 1 gram of accelerator and one full measure of sodium peroxide. In filling the measure with peroxide it should be tapped against the side of the glass jar to insure against the formation of air pockets which might prevent

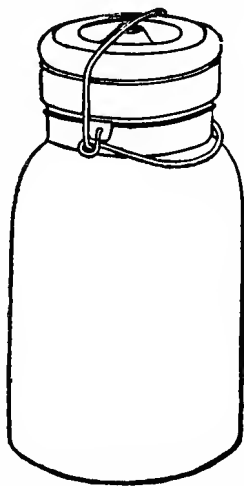

FIG. 31.—Container for sodium peroxide.

the complete filling of the measure. The measure holds approximately 14 grams. The same precaution also as to the dryness of the measure should be observed as for the fusion cup. It should be rinsed thoroughly with tap water after each using and dried by heating over a radiator or hot plate. If the accelerator is lumpy, it is well to rub it smooth in the bottom of the fusion cup.

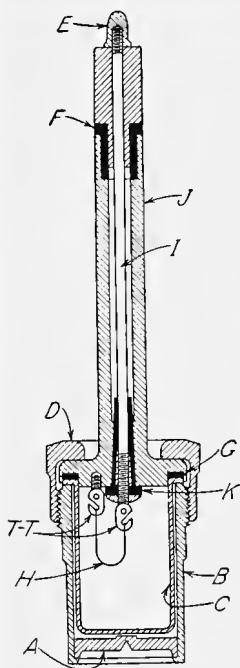

FIG. 32.

FIG. 32.—Peroxide calorimeter bomb, showing details of construction.



FIG. 33.

FIG. 33.—Bomb cup with temporary top (actual size).

Close with the temporary top, Fig. 33, and shake *thoroughly* until the ingredients are evenly mixed. Add now $\frac{1}{2}$ gram of coal. Replace the temporary cap and shake again. Avoid exposing the mixture to the air more than is absolutely necessary owing to the extreme avidity of the chemical for moisture. When mixing is complete, tap the cup lightly on the desk to shake all of the material from the upper part of the container,

remove the temporary cap and put in its place, at once, the regular cap with stem and ignition wire.¹ To attach the ignition wire, take a single length of fuse wire 7 cm. long from the card; pass one end through the eyelet of one of the terminals so it will extend beyond the eyelet, say 1 cm. Wrap the free wire around the terminal at the narrow portion formed by the notch, giving it three turns, binding in the free end and bending the wire finally downward in line with the terminal. Repeat the same process with the other end of the wire in the other terminal. Do not have the fuse loop too long. It is better if it does not extend too far into the charge. It will be noticed that the charge fills the crucible at least two-thirds full; hence, 1 cm. extension of the fuse wire below the central terminal will be ample.

See that the rubber gasket is in good shape and that the stem cap seats itself properly. It is to be noted that the gasket seals both the upper edge of the crucible and also the upper edge of the bell body. Marring the edges or rims of any of these parts, therefore, must be carefully avoided. Screw down the cap, *d*, firmly in place by use of the two wrenches; put on the spring clips with the stirring vanes downward, leaving the small holes near the lower edge of the bell body uncovered, and assemble as shown in Fig. 30. In assembling, add 2 liters of distilled water having a temperature 1 to 2°F. below that of the room and place the can in its proper position in the insulating chamber.

Ignition.—The current required for igniting the charge should be from 2 to 4 amp., and is most readily obtained by means of a rheostat or sliding resistance coil placed in series in an ordinary lighting circuit of 110 volts.

Make a number of preliminary tests by fastening a loop of

¹ Particular attention is called to the necessity of obtaining an even mixture of the ingredients. If the accelerator (KClO_3) and coal alone are used a violently explosive mixture results. If the mixing is so poorly done that lumps of accelerator and coal become segregated, a too great disturbance during the reaction may occur. There is no especial virtue in any particular order of adding the ingredients. The above method is believed to most surely promote evenness of distribution. For these reasons also the sodium peroxide should not be granular but should have the appearance, when emptied into the glass container, of a uniform powder, which would practically all pass a 20-mesh sieve.

fuse wire to the terminals and passing the current without assembling the parts. In this way the behavior of the fuse wire can be observed. Make a trial with varying resistances. If the wire does not come very quickly to incandescence, decrease the resistance until it melts in only 1 or 2 sec. after closing the circuit.

Temperature Readings.—The thermometer is inserted so that the lower end of the bulb will be about midway toward the bottom of the can. The pulley should be allowed to revolve a few minutes before reading the thermometer, in order to equalize the temperature throughout the apparatus. Take readings one minute apart for four or five intervals before igniting the charge, and continue the same for 9 or 10 min. subsequent to ignition. The first three or four readings after ignition are roughly taken, but after the fourth or fifth minute the temperature should be nearly equalized, and the readings must be carefully taken in order to ascertain the exact maximum and to furnish the necessary data for making a correction for radiation. If the temperature of the water before ignition is 1 or 2 degrees below that of the room, the temperature at the end of the first minute after ignition will be something above that of the room, and radiation for that period may be considered as self-correcting. Ordinarily, the rise in temperature will continue for about 4 min. more, at which time the maximum temperature will have been reached. The radiation for this period is found as follows: Read the fall in temperature for each minute for 4 min. after the maximum has been reached. The average drop per minute represents the correction to be added to each minute preceding the maximum, except for the minute immediately following ignition. The final temperature thus corrected for radiation, minus the initial reading before ignition, represents the total rise in temperature due to the reaction in the fusion cup.

In reading the thermometer a suitable lens should be used, preferably mounted in a manner to eliminate errors of the parallax. Tap the thermometer lightly before taking a reading in order to avoid irregularities in the surface of the mercury. It should be remembered that errors in reading the thermometer are multiplied many times in the final computation. Equalization of temperatures should be complete in about 5 min. This will always be the case if, in the process of cooling, water has been

drawn into the narrow air spaces surrounding the fusion cup. If by some mischance this entrance of the water should fail to take place it will be indicated by an absence of water within the holder around the bottom and lower part of the fusion cup. It will be evident also by a slow but very evident rise of the mercury over a period of 10 or 15 min., due to the slow conductance of the heat through the limited areas of metal contact between the holder and the cup.

Calculations.—From the total rise in temperature, corrected for radiation as above indicated, subtract the correction factors for the heat due to the chemical, fuse-wire, etc., as indicated under "Correction Factors" below, and multiply the remainder by 3,100. The product will be the number of British¹⁰ thermal units per pound of coal (see notes (a), (b) and (c) below).

It is to be noted that the heat value as derived, refers to the coal in the form in which it is weighed out for making the determination. That is to say, if a coal having 5 per cent of moisture is taken and $\frac{1}{2}$ gram of the same weighed out and dried in the oven at 212° for 1 hr., then burned in the calorimeter, the result obtained refers to the coal on the basis of 5 per cent of moisture and not to the coal as in the oven-dry state.

To calculate values to "dry coal," divide the number by 100 minus the per cent of moisture present. Thus, a coal having 5 per cent moisture and indicating 11,000 B.t.u. would have $11,000 \div .95 = 11,579$ B.t.u. on the "dry-coal" basis.

Note (a), Correction Factors.—The method for obtaining the correction for radiation has already been described under "Temperature Readings." The other correction components are listed for convenient reference as follows:

Electric fuse wire equals.....	0.003°C.	or 0.005°F.
Per cent ash is multiplied by.....	0.0025°C.	or 0.005°F.
Per cent sulphur is multiplied by.....	0.005°C.	or 0.010°F.
1 gram accelerator equals.....	0.150°C.	or 0.270°F.
Hydration factors:		
For all bituminous coals.....	0.040°C.	or 0.070°F.
For black lignites.....	0.056°C.	or 0.100°F.

Note (b).—The factor 3,100 is deduced as follows: The water used plus the water equivalent of the metal in the instrument amounts to 2,123.3 grams. In the reaction 73 per cent of the

heat is due to combustion of the coal and 27 per cent is due to the heat of combination of CO_2 and H_2O with the chemical. If now $\frac{1}{2}$ gram of coal causes 2,123.3 grams of water to rise r degrees, and if only 73 per cent of this is due to combustion, then $0.73 \times 2,123.3 \times 2 \times r =$ rise in temperature which would result from combustion of an equal weight (2,123.3 grams) of coal. $0.73 \times 2,123.3 \times 2 = 3,100.00$. The factor 2 is used instead of the divisor 0.5, the weight of coal taken.

Note (c).—The hydration factor represents the heat of combination between the chemical and water of decomposition and is a different item from the water of combustion which forms from the burning of the available hydrogen. The oxygen compounds of coal are liberated as H_2O or CO_2 and produce a small increment of heat upon uniting with the Na_2O_2 which can not be credited to the true heat of combustion. Hence, correction is applied for such compounds. This feature may also be well illustrated in the case of benzoic acid whose formula ($\text{C}_7\text{H}_6\text{O}_2$) shows the presence of an equivalent of $2\text{H}_2\text{O}$, the heat for the absorption of which should be corrected for and not counted as a part of the true heat of combustion.

To Dismantle.—Remove the thermometer, pulley and cover; then take out the can and contents entire, so that the lifting out of the cartridge will not drip water into the dry parts of the instrument. Remove the fusion cup and place it on its side in the bottom of a beaker and cover with hot water. After the fused material has dissolved, remove the cup and rinse thoroughly with hot water. Wash the face of the cap and electric terminals thoroughly. For this purpose a jet of hot water or submerging in boiling water is advisable, as the metal is thus left clean and hot, the latter facilitating the drying out of the parts. Place the parts on a radiator or near a hot plate to insure thorough drying.

Anthracites and Coke.—In the case of anthracites and coke, it is well to use 0.2 grams of benzoic acid along with the 1 gram of accelerator and $\frac{1}{2}$ gram of fuel. This substance facilitates ignition as well as the ultimate combustion. The heat resulting from the combustion of this extra 0.2 gram of benzoic acid, which is to be corrected for along with the other correction components, is $1,540^\circ\text{F}$. For hard fuels of this type it will be found of advantage to grind the sample to pass a 100 mesh sieve.

For Petroleum Oils.—The amount of oil used for a charge should not exceed about 0.3 gram; from 0.20 to 0.30 gram giving the proper combustion. The weight of oil is best obtained by means of a small light 15 cc. weighing flask provided with perforated cork and dropping tube with common rubber bulb-cap. Weigh the flask and contents, and by means of the dropping tube discharge 20 to 30 drops of oil and re-weigh, thus obtaining the weight of oil taken by difference. Determine, by experiment, the height in the dropping tube required for the approximate amount of oil desired so as to avoid trial weighings.

One gram of accelerator and one full measure of chemical (sodium peroxide) are first added and thoroughly shaken as already indicated. Also, to facilitate the ignition of all oils and at the same time promote the ultimate combustion, it is recommended that a small amount (0.2 gram) of benzoic acid be used as described under "Anthracites and Coke." Add the oil and benzoic acid last and mix thoroughly by shaking as already indicated and complete the process exactly as for coal.

Note that thorough mixing by shaking is not easily accomplished in the case of thick viscous oils. After thorough shaking of the accelerator, chemical and benzoic acid, the thick oil should be added, a few drops at a time and stirred with a nichrome wire till there is no more tendency of the oil and chemical to segregate into lumps. After closing the bomb, a final shaking will insure an even distribution of the oil throughout the charge.

Compute by means of the formula as follows:

Correcting as under coals for radiation, accelerator, benzoic acid and fuse-wire, and letting r represent the rise in temperature; then

$$\frac{r \times 0.73 \times 2,123.3}{\text{weight of oil}} = \text{B.t.u. per pound of oil.}$$

Gasoline, Etc.—For gasoline, benzene and other very volatile hydrocarbons the difficulty of securing an accurate weight of the material taken is met by the following procedure: Draw out an ordinary soft glass tube into a capillary about 1 mm. in diameter. By softening the end it may be blown into a small thin walled bulb as shown in Fig. 34. After a little practice it is not difficult to blow such bulbs to weigh less than 0.2 gram. They are used as follows: Weigh the bulb carefully, then by dip-

ping the capillary end into the liquid and alternately warming gently and cooling the bulb a quantity of the liquid may be made to flow up into it. When about 0.2 gram is obtained, seal the tip of the capillary in the flame and weigh accurately. Add the accelerator to the fusion cup in the usual manner reducing any lumps to a fine powder. Add also 0.2 gram carefully weighed standard benzoic acid and the bulb containing the liquid fuel, then over all, the measure of sodium peroxide. Press a glass

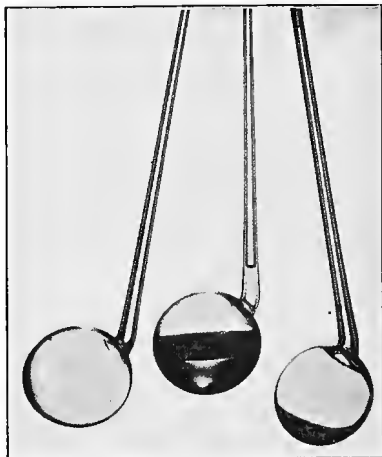

FIG. 34.—Glass bulbs, used as containers for volatile liquids.

rod down through the chemical above the bulb just sufficient to break it. Remove the rod which should be freed from adhering particles by cleaning it in the upper part of the sodium peroxide as yet unmixed with any of the other ingredients. Put in place as quickly as possible the ignition top with fuse wire attached and clamp firmly in place by means of the screw cap. Shake very thoroughly to insure complete mixing of the charge. Tap lightly on the desk to bring all of the material together and assemble for the regular procedure. In calculating, a correction is necessary, in addition to those normally observed, on account of the heat of fusion due to the glass present. This amounts to 0.03°F . for each 0.1 gram of glass used in the bulb. This should be subtracted along with the correction for accelerator benzoic

acid and fuse wire. The corrected rise, r , is then used in the formula as above given for petroleum.

Standardization.—A number of methods for the standardization of the peroxide calorimeter may be used. (a) By calculating the water equivalent for the metal a very satisfactory factor is obtained which serves as a constant in calculating the heat values. The accuracy of this method in connection with the peroxide type of instrument is due to the relatively small amount of metal employed in its construction, together with the fact that all metal parts are standardized as to weight in the process of manufacture. The total weight of metal not including the pulley and insulated part of the stem is approximately 1,370 grams. Applying a specific heat value of 0.090 gives a water equivalent for the metal of 123.3 or a total water equivalent value of 2,123.3 which is the basis for determining the constant of 3,100, as already shown under "Calculations." (b) A standard coal for which the heat value has been accurately derived by an oxygen-bomb apparatus of the Mahler type. This requires that the Mahler value be recently determined owing to the change in the apparent heat value of coal samples upon standing. It has the advantage, however, of checking the peroxide instrument with respect to the correction factors used for ash, sulphur and water of composition or "hydration." (c) By combustion of standard material as sugar or benzoic acid. The latter is usually employed. It has the advantage over the first method, (a), in that, it furnishes a test for the behavior of the thermometer, but with a thermometer of proper grade the variations on that account are due to uncertain or erroneous reading of temperatures which no method of standardization can correct.

The charge consists of $\frac{1}{2}$ gram of benzoic acid, ($C_7H_6O_2$), carefully weighed out and added to the fusion cup which already contains the accelerator and sodium peroxide thoroughly mixed exactly as in the procedure for coal. After adding the benzoic acid the cup is again thoroughly shaken to insure complete mixing of the entire charge.

After combustion in the ordinary manner and correcting the temperature rise for radiation, the accompanying factors are noted as follows:

COMPONENT FACTORS FOR BENZOIC ACID

Fuse wire.....	0.003°C. or 0.005°F.
Accelerator.....	0.150°C. or 0.270°F.
Hydration.....	0.100°C. or 0.180°F.
Total corrections.....	0.253°C. or 0.455°F.
Heat of reaction.....	2.040°C. or 3.670°F.
Total rise.....	2.293°C. or 4.125°F.

From the above it is seen that the total rise in temperature as corrected for radiation, after having the normal corrections applied for fuse, accelerator and hydration, should have a remainder, representing the true heat of combustion, of 2.040°C. or 3.670°F., since this value multiplied by the constant 3,100 gives 6,320 Cal. or 11,376 B.t.u., the accepted value for benzoic acid.

If after several check combustions, the values indicated by the instrument show a consistent variation, the average difference in heat rise should be added if + and subtracted if — from the true heat of combustion and the remainder used as a divisor for the accepted value thus: with an excess indication of 0.02°F. we would have:

$$\frac{11,376}{3.690} = 3,083.$$

That is, the constant for the instrument is 3,083 instead of $\frac{11,376}{3.67} = 3,100$.

CHAPTER XXI

CALORIMETRY USING THE OXYGEN BOMB

General Statement.—In the Mahler or Berthelot type of instrument, the fuel for combustion is held in a tray supported

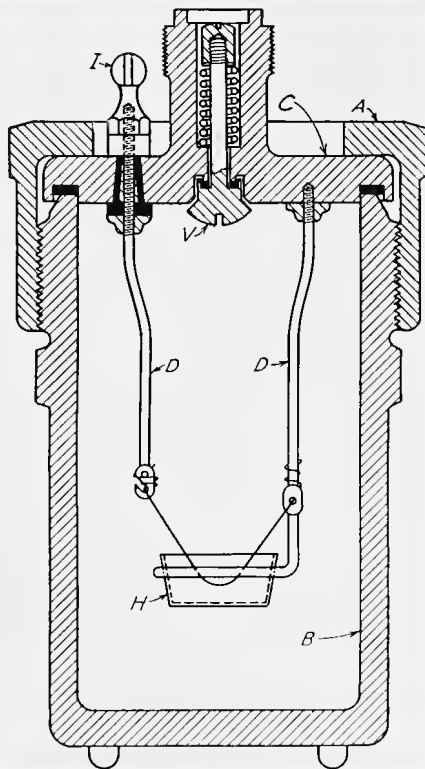

FIG. 35.—Cross section of Parr oxygen bomb.

within a chamber capable of receiving oxygen under a pressure of 25 to 30 atmospheres. Figure 35 represents such a bomb, the essential parts of which are the cover, *C*, held in place by the

screw clamp, *A*, the supporting wires, *D*, for the fuel tray, *H*, which also are the terminals for conducting the electric current through the fine fuse wire. The assembling of the bomb in the

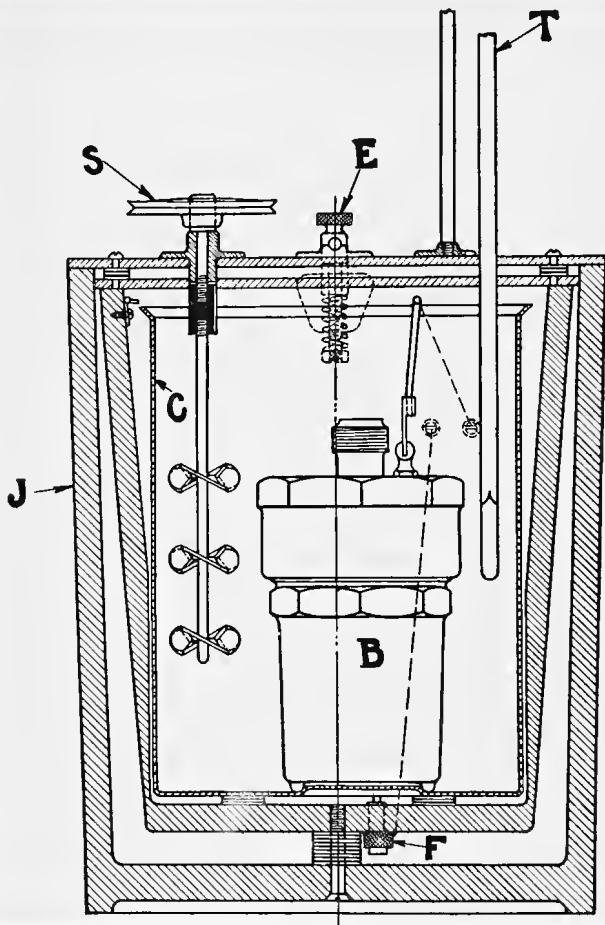

FIG. 36.—Parr oxygen bomb calorimeter, showing details of construction.

calorimeter proper is shown in Fig. 36. The bomb is placed a little to one side of the center of an oval can thus leaving space at one axis of the oval for a stirrer, *S*, and at the other for a thermometer, *T*. Protection from heat interchanges with the

surrounding air is provided by walls of indurated fiber with an air space between and this arrangement is continuous for sides, bottom and top. Another method of insulation by circulation of water through the jacketing spaces is also to be noted. The fuse wire is No. 34, Brown & Sharpe gage, and is usually of pure iron though on some accounts a wire more resistant to oxidation is desirable. A current of low voltage 10 to 15 volts is to be preferred so that arcing within the calorimeter may be avoided.

The capsule should be immune to chemical action and if of sufficient size the necessity of compressing the fuel into a tablet is obviated. Trays approximately 25 mm. in diameter by 12.5 mm. deep should be used.

Oxygen bomb calorimeters of the Mahler or Berthelot type, naturally, by inheritance or custom, ordinarily are equipped with thermometers graduated in degrees Centigrade. Unless otherwise indicated, therefore, references to temperature readings in connection with instruments of this type are understood to be on the Centigrade scale.

Heat Values by Oxygen Bomb Calorimeter.—Figure 35 shows the arrangement of the parts of the bomb when ready for placing in the calorimeter. When the calorimeter is dismantled the double cover to the insulating chamber should be supported on a ring-stand or similar device as shown in the cut, Fig. 37. This affords a convenient method of handling the stirring device and insures greater safety for the thermometer.

When the bomb is opened and made ready to receive the charge of fuel, the cap is most conveniently held on a ring-stand. Thus supported, the fuel capsule and fuse wire are readily adjusted. For coal approximately one gram of the air-dry sample, ground to pass a 60-mesh sieve, is accurately weighed in the capsule, *H*, Fig. 35. Attach the ignition wire to the terminals by passing one end through the eyelet of one of the terminals so it will extend beyond the eyelet about 1 cm. Wrap the free wire around the terminal at the narrow portion formed by the notch, giving it three turns, binding in the free end and bending the wire finally downward in line with the terminal. Repeat the same process with the other end of the wire. The fuse wire should be about 7 cm. long. That part of the wire between the

terminals should be bent into a somewhat narrow U-shaped loop so that the fuse wire will not touch the sides of the capsule, Fig. 35. Adjust the wire so that the lower part of the fuse loop will just touch the surface of the coal. In using sugar for

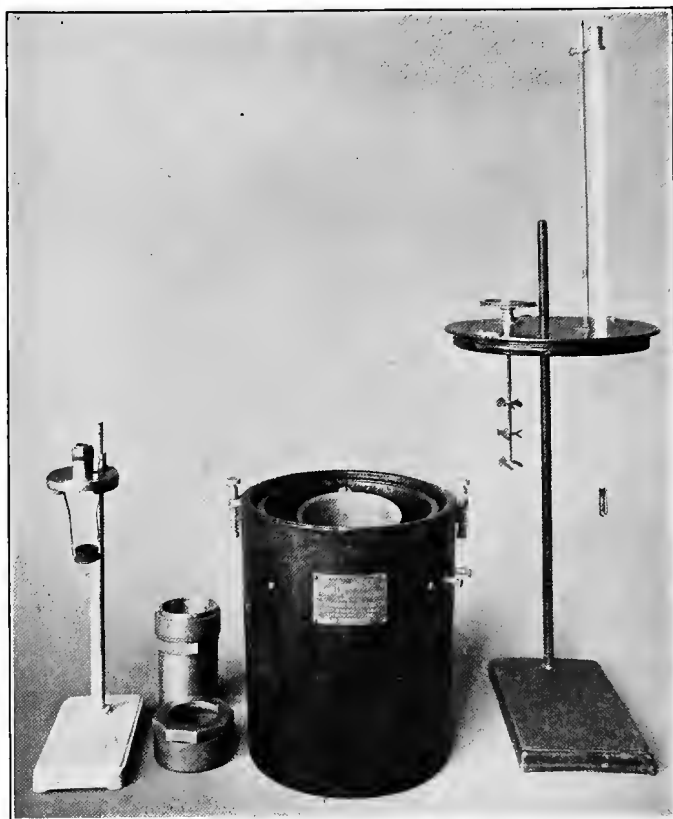

FIG. 37.—Oxygen bomb calorimeter, dismantled.

standardizing purposes it is well to give the wire a number of short turns in such a manner that the spiral will come in contact with the sugar, which is difficult to ignite with the wire in a simple loop. Benzoic acid or naphthalene are easy to ignite and do not need the extra looping of the wire. In the case of

naphthalene, to insure against loss of the charge upon igniting, it is well to heat approximately 1 gram in the capsule to the point of incipient fusion and then obtain the accurate weight. The cake-like mass will readily ignite if the wire loop simply touches the surface. Loss by volatilization or spurting is thus avoided.

In the case of coal or standard material the amount to be taken is a matter of choice. An exact gram simplifies slightly the calculations, but is apt to prolong unduly the weighing process. A small amount of water, 0.5 to 1.0 gram is added to the bomb

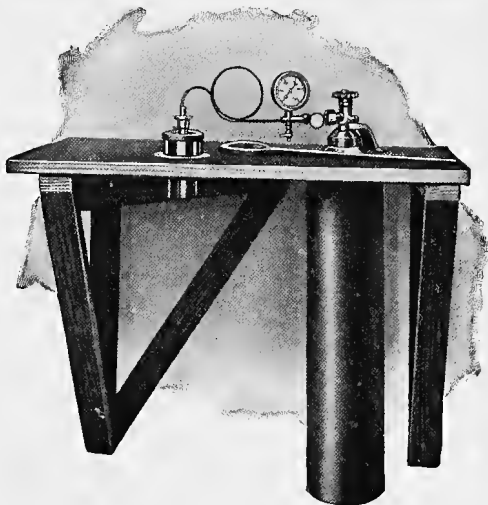

FIG. 38.—Method of filling oxygen bomb with oxygen.

which is placed in the octagon holder for receiving the cover with the fuel and capsule in place. In turning down the cap upon the cover apply the large wrench using good firm pressure, though only moderate force is necessary for securing a perfect seal at the rubber gasket.

For filling with oxygen, connection is made with the flexible copper tubing (see Fig. 38) and oxygen is admitted until a pressure of 25 to 30 atmospheres is indicated. In admitting the oxygen the needle valve next to the pressure gage is opened slightly to avoid a sudden rush of gas. After a sufficient amount has been admitted, close the needle valve and open the pet cock below the gage in order to release the oxygen under pressure in

the tube and connections. The check valve, *V*, Fig. 35, automatically closes and retains the oxygen at the desired pressure.

Transfer the bomb carefully, without jarring, to the oval can which has been placed in position in the calorimeter. The long axis of the oval should be in line with the operator, that is, at right angles to the work desk. The pointer, Fig. 37, and a notch in the can directly opposite, serve as guides for correctly locating the vessel. The circular elevation in the bottom which directs the locating of the bomb should be toward the operator. Turn the bomb so that one of the faces of the octagon, rather than an angle, will be toward the operator, thus giving more room for the thermometer. Make the connection with the electric terminal, and add 2,000 grams of water, preferably distilled. The temperature of the water should be 1 or 2°C. below that of the room.

In placing the cover on the calorimeter have the thermometer toward the operator. This will bring the pulley with turbine stirrer at the back of the instrument. Bring the cover to place carefully so as to avoid striking the thermometer against the metal parts (see Fig. 36). Seat the spring clips for holding the cover firmly in place and connect the pulley with the motor. The motor is adjusted so as to give the turbine pulley a speed of about 150 r.p.m. turning to the right or clockwise. A uniform speed throughout a determination is desirable.

By use of the telescopic lens, readings of the thermometer for the *preliminary period* are taken at 1 min. intervals for 5 min. At the fifth reading close the electric circuit for a second or not to exceed 2 sec. Ignition of the sample should be indicated by a rise of the mercury, which becomes rapid after 20 or 30 sec. The *combustion period* extends over 5 or 6 min. and terminates when the maximum temperature has been reached, or when the rate of change has become uniform. The *final period* follows the combustion period. Readings are taken at minute intervals for 5 min. The temperature readings for these periods furnish the basis for determining the temperature changes due to radiation as follows:¹

¹ See report of Committee on Methods of Coal Analysis, *Jour. Ind. and Eng. Chem.*, vol. 5, p. 517, 1913.

Also, U. S. Bureau of Standards, *Circular 11*. Detailed discussion in Part I, p. 40, should also be consulted.

The following notations should be made.

1. The rate of rise (r) for the preliminary period in degrees per minute.
2. The time (a), at which the last reading of the preliminary period is made, immediately before firing.
3. The time (b) when the rise of temperature has reached six-tenths of its total amount. This point can generally be determined by adding to the temperature reading at the time of firing 60 per cent of the expected temperature rise and noting the time (b) when this point is reached. If the approximate temperature rise is not known, six-tenths of the total rise as subsequently developed, when added to the temperature reading at (a), will indicate the time (b) by interpolating readings, which should be taken at 15 sec. intervals for 2 min. after firing.
4. The time (c) when the maximum temperature has been reached, or when the rate of change has become uniform, usually about 5 min. after firing.
5. The rate of change (r_2) for the final period in degrees per minute.

After combustion dismantle the calorimeter by removing the cover of the insulating fiber jacket which should be placed in a suitable holder to guard against breaking the thermometer, Fig. 37. Transfer the bomb to the octagon holder in the bench (see Fig. 38) and release the oxygen from the bomb by pressing down upon the valve V . Do not try to remove the screw cap, A , until after the gas pressure has been released. Upon opening the bomb if any unburned carbon is found the experiment should be rejected.

Corrections.—(1) Apply the corrections as indicated on the thermometer certificate for the initial (a) and final (c) readings.

Determine the corrections for radiation as follows:

Multiply the rate (r) by the time ($b - a$) in minutes and tenths of a minute and add the product to the corrected temperature reading at time (a), or subtract it if the temperature was falling at time (a).

Multiply the rate (r_2) by the time ($c - b$) and add (or subtract if the temperature was *rising* during the final period) the product to the corrected temperature reading at time (c).

The difference of the two readings thus modified to account for thermometer scale and radiation corrections gives the total rise of temperature.

2. Multiply the total rise thus found by the water equivalent of the calorimeter, the product giving the total amount of heat liberated. If the thermometer readings were in Fahrenheit

degrees the product gives the heat value in B.t.u. Unless otherwise stated the readings with the oxygen bomb instrument are considered as Centigrade and the ultimate values are in calories.

3. The total heat as obtained under (2), after calculating to calories, is to be further corrected on account of the formation of nitric and sulphuric acids in the reaction. Correction for these acids however is most conveniently brought to the basis of the heat units involved as follows: Wash the bomb thoroughly with hot distilled water and titrate the washings with a standard solution of sodium carbonate. Make up the sodium carbonate solution by dissolving 3.658 grams of chemically pure Na_2CO_3 in one liter of distilled water. Each cubic centimeter of the sodium carbonate solution represents an amount of nitric acid producing 1 cal. in the reactions involved.

The additional correction for sulphuric acid as shown on page 44, Part I, requires that a determination of sulphur be at hand. It can be made from the washings after titrating for the acids either by the gravimetric or photometric method. Multiply the per cent of sulphur present by 13. The product equals the number of calories to be combined with the number found by titration. Add also the correction indicated for the fuse wire which will equal substantially 2.8 cal. for each centimeter burned. The sum represents the total correction in calories to be subtracted from the amount obtained from the total corrected temperature under (b).¹

Finally, note that the total indicated heat as corrected for nitric acid, sulphuric acid, and fuse wire, refers to a quantity of fuel represented by the weight of the charge taken. If this weight were exactly 1 gram no further computation is necessary. If the weight taken varied from an even gram, the indicated calories as above derived must be divided by the weight of fuel taken.

Note especially, also, that if a thermometer with the Fahrenheit scale is used the values are in B.t.u. but the corrections for acid and fuse wire must be changed to correspond. In this case it will be simpler to make up the standard Na_2CO_3 solution by using 2.032 grams per liter and increasing the titration factor by

¹ For further discussion of corrections see Part I, Chap. VI.

23 times the per cent of sulphur. The wire factor also should be taken as 5 units per centimeter of length. Calculations from these values will, then, all be in B.t.u. which are subtracted from the total indicated B.t.u. to cover the corrections involved.

Standardization.—To standardize the instrument, make a combustion using a standard substance of known heat value, as pure benzoic acid. Add to the accepted heat value of the quantity taken, say 1 gram, the heat due to the combustion of the wire and the nitric acid formed. Divide the heat value thus represented by the temperature rise, corrected in the usual manner. The quotient represents the total water equivalent made up to the actual grams of water employed, 2,000 plus the equivalent in water of the metal parts, etc. of the apparatus. The substances most commonly used with the values recognized by the U. S. Bureau of Standards are:

Benzoic acid.....	6,320 cal. per gram
Naphthalene.....	9,622 cal. per gram
Cane sugar.....	3,949 cal. per gram

Variations from these values due to impurities may still permit of the substances being used provided the values themselves have been carefully determined under properly standardized conditions.

Adiabatic Conditions.—In the case of an adiabatic calorimeter, Fig. 13, assuming that perfect adiabatic conditions are maintained, the matter of obtaining a correct temperature reading is greatly simplified.

Before starting the combustion the jacketing water should be brought to exact equilibrium with the water surrounding the oxygen bomb. This should be maintained for 2 or 3 min. to insure that exact equilibrium conditions have been established. After ignition the outer system should be advanced in temperature with the inner unit until equilibrium conditions are again established. During this period of active advance the two thermometers may momentarily be separated slightly as to their temperature indications but such variations would not introduce measurable amounts of radiation loss or gain unless continued over a considerable length of time. Moreover, it should not be difficult to confine such thermometer variations

within a range of less than one-tenth of a degree. As the final stage is approached, these variations may be reduced to the point of practical elimination.

The corrections and calculations therefore would be:

- (a) Apply stem corrections for the thermometer at the initial and final readings.
- (b) Multiply the rise by the water equivalent of the instrument.
- (c) Subtract the calories due to the formation of HNO_3 , H_2SO_4 and fuse wire.
- (d) Divide by the weight of the sample taken.

CHAPTER XXII

SULPHUR DETERMINATIONS

General Statement.—In the ordinary proximate analysis, the sulphur content of coal is distributed between the volatile matter and the coke. This distribution follows no definite plan, though very frequently the sulphur divides itself about equally. Since the sulphur is thus included in the factors obtained, the results total 100 per cent. The factor for sulphur therefore is independent of the other components and to avoid confusion should be reported on a separate line and not listed with the constituents determined by proximate analysis.

The sulphur content is primarily of interest to the analyst because of the necessity of knowing this factor in making the necessary calorimetric corrections for both the peroxide and the oxygen bombs. The user of the coal in combustion processes looks upon the sulphur percentage as a fairly reliable index of the tendency of the coal toward clinker formation. The gas and coke maker prescribes a low percentage as a maximum quantity beyond which the coal is unsuited for this purpose. In all these cases therefore the total sulphur content is required. The methods of analysis are mainly directed therefore to this end. For some purposes, however, the ratio of distribution as between the mineral or pyritic sulphur and that which is in organic combination is desired and brief reference to such determinations are included.

Total Sulphur.—(a) The washings from an oxygen bomb calorimeter give values which are sufficiently accurate for the corrections needed in the use of that instrument. The washing should be thorough and hot water is preferred. Heat the washings to boiling with a few cubic centimeters of dilute (1 : 1) HCl to which a little bromine water has been added. The ash and insoluble sulphates remaining should be filtered off and also washed with hot water. Make neutral to methyl orange by means of sodium hydroxide or carbonate, acidify with 1 cc. of approximately normal HCl and heat to boiling. The bulk of the solu-

tion should not exceed about 200 cc. Add slowly from a pipette, with constant stirring, 10 cc. of a 10 per cent solution of barium chloride ($\text{BaCl}_2 \cdot 2\text{H}_2\text{O}$). Continue boiling for 15 min. and allow to stand for 2 hr. or over night. Decant the supernatant liquid, filter through an ashless filter and wash thoroughly. Transfer the wet filter to a weighed crucible and smoke off the paper carefully to avoid spattering and so slowly that the filter paper does not burn with a flame. Finally heat to 900 or 950°C. and weigh. The amount of sulphur in BaSO_4 is 13.734 per cent.

Attention should be called to the following notation made in the preliminary report of the committee on Methods of Sampling and Analysis of Coal.¹

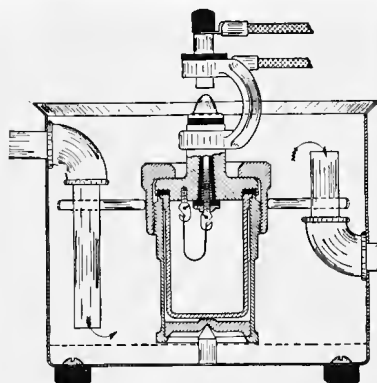

FIG. 39.—Cross section of electric ignition sulphur bomb and water jacket.

(b) The Eschka method has been long in use and is frequently the standard of reference. It has the disadvantage of being long and requiring careful regard to sulphur in the reagents and the gas used for heating. The Eschka mixture is prepared by incorporating 2 parts of magnesium oxide with 1 part of sodium carbonate and passing through a 40-mesh screen.

Weigh out 1 gram of coal and thoroughly mix with 3 grams of the Eschka mixture. This is best carried out on a sheet of glazed paper from which it is transferred to a No. 0 porcelain or other suitable crucible and covered with about 1 gram additional of Eschka mixture. Heat gradually in a muffle till a final temperature of approximately 900°C. or a cherry-red is attained. Continue the heating with occasional stirring for about an hour, or until all particles of carbon have been burned. Cool and digest with about 100 cc. of hot water for $\frac{1}{2}$ to $\frac{3}{4}$ hr. Filter by decantation and wash the residue a number of times with hot water. Finally transfer to the filter and wash four or five times. The filtrate should not exceed 250 cc. Add 10 to 20 cc. of saturated bromine water. Acidify and boil to expel the bromine.

¹ *Proc. Am. Soc. for Testing Mat.*, vol. 14, 432, 1914.

Make neutral to methyl orange by means of NaOH or Na_2CO_3 and add 1 cc. excess of normal HCl. Precipitate as under (a) and complete the gravimetric determination in the usual manner as there indicated. Blank determinations should be made on the reagents employed and corrections applied to correspond.

(c) The method by fusion with sodium peroxide is in all respects the most convenient to use. The residue from a calorimetric determination may be utilized or a special bomb for sulphur determinations may be used. The fusion cup method of ignition and making up the charge are the same in either case. Figure 39 shows the apparatus as assembled for firing by means of an electric current. The bomb cup alone with temporary cover is shown in Fig. 33. In this form it is well adapted to that part of the procedure which consists of combining and mixing the ingredients of the charge. One gram of accelerator is placed in the bottom of the fusion cup and freed from lumps. One measure of Na_2O_2 is added and thoroughly mixed with the accelerator by shaking. The $\frac{1}{2}$ gram of coal is then added and shaken. Some operators prefer to add the coal to the accelerator and mix the two with a glass rod and then add the peroxide with subsequent thorough mixing by shaking. If the peroxide is not forgotten or if the mixing by shaking is not disregarded that procedure is a good one. It is sometimes the practice to ignite the charge in the simple container, shown in

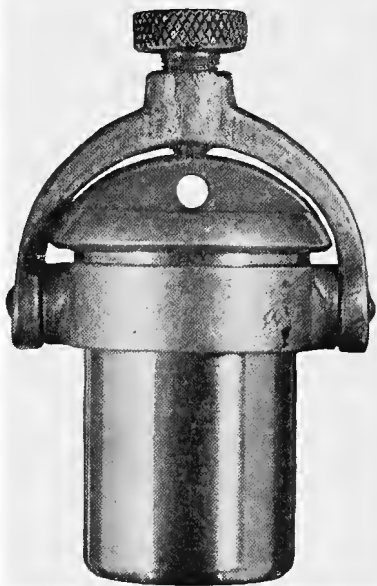

Fig. 40.—Sulphur bomb, common type, for heat ignition (actual size).

Fig. 40, by causing a pointed flame from a blast lamp to impinge upon the bottom or side of the fusion cup for a brief period, sufficient to start the reaction. In such a case it is vitally important that the mixture of coal and accelerator (KClO_3) should be mixed throughout the peroxide which then serves as a diluent and

slows down the reaction to a moderate speed, thus avoiding the explosive character of the chlorate and coal alone. If therefore the Na_2O_2 is forgotten or the mixture of coal and chlorate are left undisturbed at the bottom of the fusion cup, a serious explosion may result.

A pointed flame from a blast lamp is preferred instead of the full flame of a Bunsen burner. By such means a localized portion of the fusion cup becomes red hot and ignites the charge at one spot from which the reaction proceeds moderately throughout the mixture thus avoiding the violent reaction which may accompany the use of a full flame of large volume. After ignition has started the reaction will be complete in a very short time so that after the lapse of 10 or 15 sec. the apparatus may be brought under the tap for cooling.

After the reaction is complete and the bomb is sufficiently cool to handle, remove the fusion cup and place in a small beaker of 250-cc. capacity. Add water and cover the beaker with a watch glass. After solution is complete rinse and remove the fusion cup and add concentrated HCl to the neutral point. This will require 25 to 30 cc. of acid. Add about 1 cc. of normal acid in excess, filter if necessary, wash and make up the solution to about 225 cc. Precipitate the sulphates by means of barium chloride exactly as indicated under (a). Particular attention should be observed in washing the precipitate obtained by this method in order to remove all of the soluble salts which are formed in the fusion process.

(d) The photometric method for arriving at the factor for sulphur is extensively used and has many features of advantage especially in technical work. It is applicable to any of the solutions obtained under (a), (b), or (c) above, at that point where the solution is ready for precipitation by means of barium chloride. It is especially advantageous in method (c) where the peroxide fusion has been employed for the reason that separation from the heavy alkaline salts is not involved. The details of the process are as follows: After dissolving out the material from the fusion cup, acidify and filter as directed under (c). The precipitation with barium chloride is made in a different manner however. Instead of a coarse granular precipitate which will settle readily, a fine non-settling precipitate is sought

which will more nearly approach the colloidal form. This is obtained by using crystals of BaCl_2 of approximately uniform size as indicated below.

Make up the slightly acid solution to 250 cc. Measure out 50 cc. for the turbidity test and make up to 100 cc. Transfer

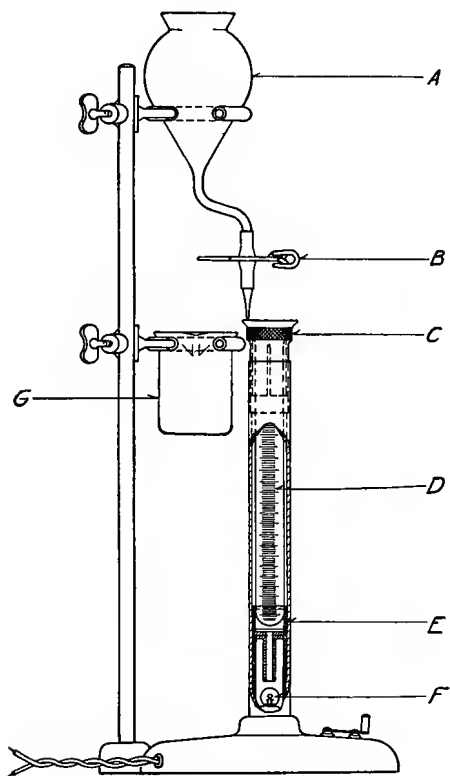

FIG. 41.—Sulphur photometer.

this solution to a suitable flask and add 0.3 to 0.5 gram of barium chloride crystals which have been specially prepared by sifting through a 20 mesh sieve and selecting for use those which are retained on a 30 mesh sieve. Without delay close the flask with the cork and shake vigorously for 1 or 2 min., then allow

to stand at room temperature, with occasional shaking, for 5 to 20 min.

In reading the turbidity, the solution is shaken and a portion poured from the flask into the wide-mouthed dropping funnel, *a*, Fig. 41. The graduated tube, *d*, is adjusted in the dark tube

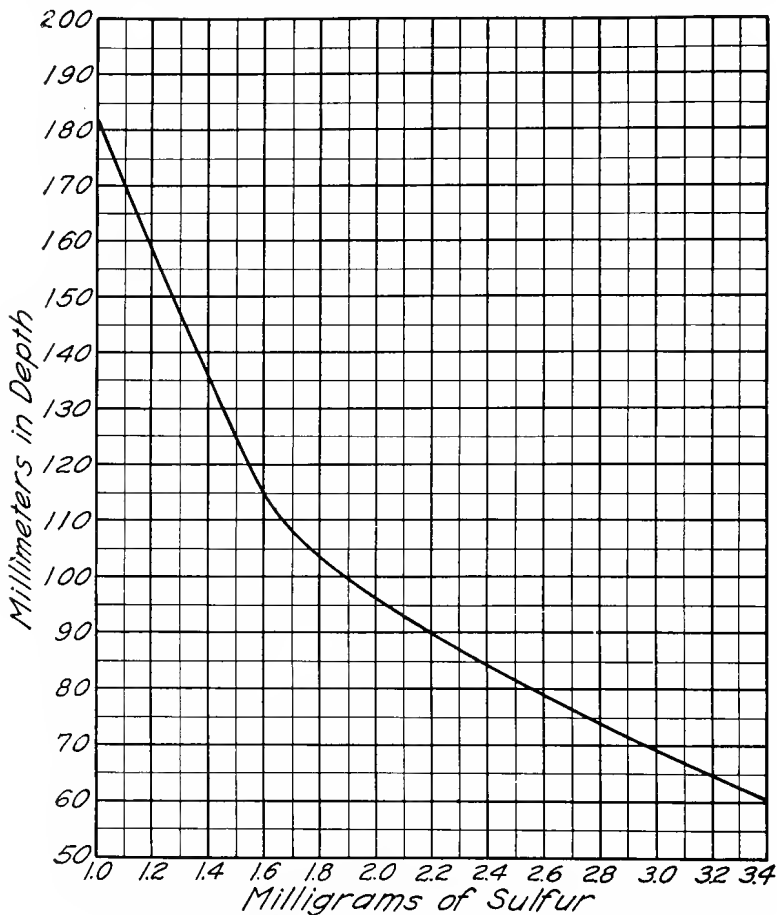

FIG. 42.—Typical curve for use with sulphur photometer.

so that the rounded lower end dips well into the water, which should be about 1 cm. in depth in the capsule, *e*.

By means of the pinch cock admit the turbid solution until the point of light from the lamp, *f*, just disappears, the last point

of light being no longer visible. Do not take account of the slightly luminous center that appears when the amount of sulphur is high and the readings are on the lower portion of the scale, say from 50 to 60 mm. Take as the end point the complete disappearance of the light. Remove the tube and read in milligrams the depth of the liquid. By means of the table or curve, Fig. 42, is shown the weight in milligrams of the sulphur present in the 100 cc. of solution. If 50 cc. were taken from the 250-cc. flask, and this latter contained the fusion from a $\frac{1}{2}$ -gram sample of coal, then the sulphur reading would be the weight present in $\frac{1}{10}$ gram of coal. By removal of the decimal point, therefore, one place to the right, there would be shown the weight of sulphur in 1 gram of coal which can then be read in parts per 100, or per cent, by placing the decimal two more places to the right. If read in milligrams each unit is then 1 per cent.

For example, if the results show a depth of 105 mm., there would be indicated 1.78 mg. of sulphur present in the quantity taken, that is 0.00178 grams. Now, if $\frac{1}{5}$ of the $\frac{1}{2}$ gram of coal is represented in this amount, the reading is for $\frac{1}{10}$ gram of coal. For 1 gram of coal there would then be 0.0178 gram of sulphur, or 1.78 per cent.

If the sulphur is so great in amount as to afford too great turbidity for satisfactory reading, repeat the process, measuring out 25 cc. of the solution and diluting with water sufficient to make a total of 100 cc. in volume, and proceed as above outlined. After multiplying the weight of the sulphur thus indicated by 2, the conditions will be the same as indicated above.

In cases where the content of sulphur in the coal is so low that the reading on the tube comes above the limit of graduation, a larger quantity of the solution representing a greater amount of coal should be taken. Thus, if we take 100 cc. of the solution, we will be taking $\frac{2}{3}$ of $\frac{1}{2}$ gram of the original coal or $\frac{1}{3}$ (0.2) gram of coal. Now, the sulphur indicated on the curve will be the weight in milligrams which accompanies 0.20 gram of coal. If, therefore, we read the percentage as normally indicated and divide by 2, we will have the correct indication for the content of sulphur. For example, if the reading under these conditions shows a depth of 105 mm. there would be indicated 1.78 mg. of sulphur for the amount of coal taken, 0.2 gram. This would be 0.89 mg. for 0.20 gram of coal, or 0.89 per cent.¹

Special care must be taken to prevent the settling out of the precipitate. A reading can be quickly made and the contents of the tube poured back into the funnel. Readings should be repeated several times, thus keeping the mixture stirred and affording greater accuracy as to the final average taken. Before beginning, the bottom of the tube inside should be cleansed by means of a swab to insure that no film of precipitate from the previous test has settled out.

For the same reason be sure that no sediment has settled out on the bottom of the cup, *e.* Perfect alignment of the light through the diaphragm and tube should be secured. The conditions as to strength of light,² methods of reading, the end point, etc., may vary from the standards adopted in the table. Each individual should check his own method and modify the curve to correspond by making up a solution of chemically pure potassium sulphate, having 0.5444 gram per liter, which is equivalent to 0.0001 gram of sulphur per cubic centimeter. Use 15 or 20 cc. in making the test and precipitate as in the regular determination. The photometer curve, Fig. 42, has been developed under the same solution conditions as those accompanying the precipitation of the sulphate from the sodium peroxide fusion in which there has been formed about 15 grams of NaCl. Since the character of the turbidity precipitate is modified somewhat by the presence of sodium chloride, it is advisable that this feature be reproduced in all standardization tests. The effect of the presence of sodium chloride is substantially the same for any amount from 1 to 6 grams in each 100 cc. as made ready for the photometer, hence the most convenient procedure will be to prepare a solution of 30 grams of NaCl in 250 cc. of water and use 25 cc. of it in making up the measured amount of standard sulphate to 100. Similarly, the amount of free HCl in the 100 cc. volume should be duplicated by adding 2 cc. of conc. HCl to the 250 cc. solution of NaCl.

¹ Some coals, especially of the semi-bituminous or Pocahontas type, have a content of sulphur so low as to make it advisable in such cases to dissolve the fusion in a smaller quantity of water, so that the volume when made up shall be 100 cc. With sulphur so low as 0.5 per cent the entire solution would be required for use with the photometer.

² A small 3-volt tungsten bulb with current from two dry cells is used as a standard light.

CHAPTER XXIII

ULTIMATE ANALYSIS OF COAL

Total Carbon Determination.—The percentage of total carbon in the coal used is a necessary factor in determining the heat

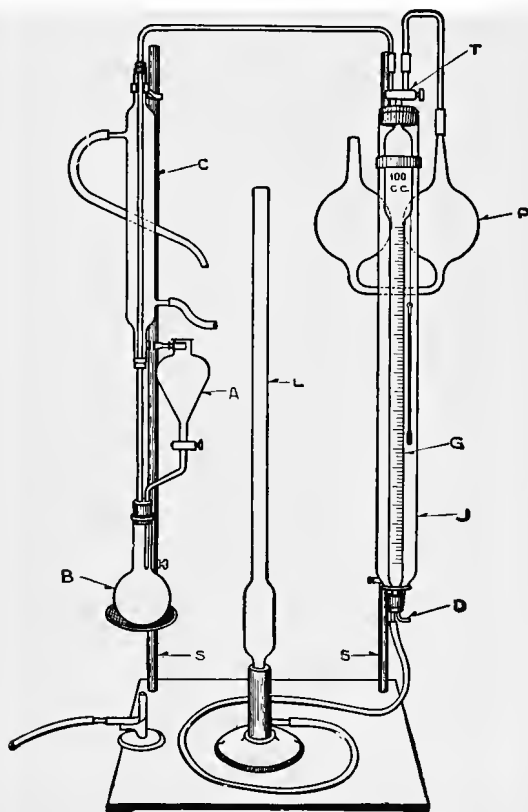

FIG. 43.—Total carbon apparatus.

losses in the flue gases as already indicated in the discussion on pages 107–110 inclusive. This value may be obtained by utiliza-

tion of the sodium peroxide fusion in which the total carbon of the coal has been oxidized and combined with chemical to form Na_2CO_3 . By liberating the CO_2 under accurately determined conditions as to temperature and pressure by means of the apparatus shown in Fig. 43, the amount of carbon present may be derived from the volume of CO_2 discharged.

The apparatus should be located on a laboratory desk or table where an even temperature can be maintained.

Fill the jacketing tube *J* with water slightly acidulated to keep it clear. Fill the leveling tube *L* with water that has had 2 or 3 cc. of sulphuric acid added. A few drops of methyl orange in the leveling tube will impart a color to the water, greatly facilitating the readings.

Connect the inlet *D* with air pressure and adjust so that two or three bubbles of air per second will enter the jacketing water. This is for the purpose of keeping the temperature of the water equalized throughout a determination. By reading the thermometer hung in the water the temperature of the gas under observation is obtained.

The operation is as follows: The large double pipette *P* is half filled with 40 per cent solution of caustic potash, or such as is ordinarily used for the absorption of CO_2 gas. By turning the three-way cock *T* to connect with the pipette *P* and lowering the leveling tube *L* the liquid in *P* is brought into the right-hand bulb and made to rise in the capillary tube to the mark on the right limb of the capillary. The three-way cock is now closed to the pipette bulb and opened to the tube running to the flask *B*. By raising the leveling tube *L* the liquid in the burette *G* is made to rise to the three-way cock *T*, thus completely filling the burette. The three-way cock is now closed to retain the liquid in the burette at the zero point, till evolution of the gas is begun.

The cup containing the fused material from a calorimetric determination is placed on its side in the bottom of a small beaker and covered with hot water that has been boiling for 5 or 10 min. Contamination with CO_2 from the water used or from contact with the air must be avoided as much as possible. When the fusion is dissolved remove the cup, rinsing it well, and pour the solution directly into the flask *B*. Wash out the beaker thoroughly with hot water and pour the washings in with the

main portion. Connect the flask with the funnel tube *A* and bring the ring support with wire gauze in place under the flask. Open the stop cock at the lower end of the funnel and boil the contents of the flask for 3 or 4 min. Remove the flame and at once close the funnel cock. In this way the oxygen from the sodium peroxide will be driven off together with the air in the flask. Also, when the three-way cock *T* is closed there will be a partial vacuum in the flask.

With the cock to the funnel tube *A* closed, enough acid is added to *A* to completely neutralize the alkaline solution in *B* and leave a distinct excess of acid. Hydrochloric acid is preferred. Thirty cubic centimeters of concentrated hydrochloric acid will be found sufficient.

To operate, lower the leveling tube *L*, open the three-way cock *T* to the tube connecting with the flask *B* and admit acid drop by drop from the funnel *A*. Meantime the circulating water for the condenser *C* should be turned on.

When the evolution of gas has about reached the capacity of the graduated burette *G*, the acid is shut off, the three-way cock *T* closed and a reading of the volume of the gas carefully taken by bringing the two surfaces of liquid in the leveling tube and burette exactly on a level. Read also the temperature of the jacketing water and note the barometric pressure. The cock *T* is now opened to the capillary and the gas volume forced completely over into the bulb *P* where it is held by closing the cock *T*. Here it is left for complete absorption of the CO_2 . The cock *T* may be again opened to connect with the flask *B*, the liquid in the burette *G* being at the zero point as before. The apparatus is now ready for a second evolution and measurement of a gas volume.

A second reading is similarly taken and the volume driven over into *P* as before, along with the former volume. Repeat the process until no more CO_2 is evolved.

Finally heat is added to the flask *B* and after a few minutes boiling, hot water is added through the funnel *A*, until the solution is nearly up to the stopper, the flame of course being removed. At this point there should be no water remaining in the funnel *A*. Lower the leveling tube *L* to form a partial vacuum and allow air to be drawn through *A* into *B* and thus

TABLE XXI.—WEIGHT OF CARBON IN MILLIGRAMS
 Calculated from 1.976 = weight of 1 liter of CO₂ at 41° latitude

<i>t/p</i>	720	722	724	726	728	730	732	734	736	738	740	742	744
10	.4851	.4864	.4878	.4891	.4905	.4919	.4933	.4947	.4960	.4974	.4987	.5001	.5014
11	.4829	.4842	.4856	.4869	.4883	.4896	.4910	.4924	.4937	.4951	.4964	.4978	.4991
12	.4806	.4819	.4833	.4846	.4860	.4873	.4887	.4901	.4914	.4928	.4941	.4955	.4968
13	.4783	.4796	.4810	.4823	.4837	.4850	.4864	.4878	.4891	.4905	.4918	.4932	.4945
14	.4760	.4773	.4787	.4800	.4814	.4827	.4841	.4855	.4868	.4882	.4895	.4908	.4921
15	.4737	.4750	.4764	.4777	.4791	.4804	.4818	.4832	.4845	.4858	.4871	.4884	.4897
16	.4714	.4727	.4741	.4754	.4768	.4781	.4795	.4808	.4821	.4834	.4847	.4860	.4873
17	.4691	.4704	.4718	.4731	.4745	.4758	.4771	.4784	.4797	.4810	.4823	.4836	.4849
18	.4668	.4681	.4694	.4707	.4721	.4734	.4747	.4760	.4773	.4786	.4799	.4812	.4825
19	.4644	.4657	.4670	.4683	.4697	.4710	.4723	.4736	.4749	.4762	.4775	.4788	.4801
20	.4620	.4633	.4646	.4660	.4673	.4686	.4699	.4712	.4725	.4738	.4751	.4764	.4777
21	.4596	.4609	.4622	.4636	.4649	.4662	.4675	.4688	.4701	.4714	.4727	.4740	.4753
22	.4572	.4585	.4598	.4612	.4625	.4638	.4651	.4664	.4677	.4690	.4703	.4716	.4729
23	.4548	.4561	.4574	.4587	.4600	.4613	.4626	.4639	.4652	.4665	.4678	.4691	.4704
24	.4523	.4536	.4549	.4562	.4575	.4588	.4601	.4614	.4627	.4640	.4653	.4666	.4679
25	.4498	.4511	.4524	.4537	.4550	.4563	.4576	.4589	.4602	.4614	.4627	.4640	.4653
26	.4473	.4486	.4499	.4512	.4524	.4537	.4550	.4563	.4576	.4588	.4601	.4614	.4627
27	.4447	.4460	.4473	.4486	.4498	.4511	.4524	.4537	.4550	.4562	.4575	.4588	.4601
28	.4421	.4434	.4447	.4460	.4472	.4485	.4498	.4511	.4524	.4536	.4549	.4562	.4575
29	.4395	.4408	.4420	.4433	.4445	.4458	.4471	.4484	.4497	.4509	.4522	.4535	.4548
30	.4368	.4381	.4393	.4406	.4418	.4431	.4444	.4457	.4470	.4482	.4495	.4508	.4521
31	.4341	.4354	.4366	.4379	.4391	.4404	.4417	.4430	.4443	.4455	.4468	.4481	.4494
32	.4314	.4327	.4339	.4352	.4364	.4377	.4390	.4402	.4415	.4427	.4440	.4453	.4466
33	.4286	.4299	.4311	.4324	.4336	.4349	.4362	.4374	.4387	.4399	.4412	.4425	.4438
34	.4258	.4271	.4283	.4296	.4308	.4321	.4334	.4346	.4359	.4371	.4384	.4396	.4409
35	.4230	.4242	.4255	.4267	.4280	.4292	.4305	.4317	.4330	.4342	.4355	.4367	.4380

sweep out the residual gas in the connecting tubes into the burette *C*. The amount of air thus drawn in should be slightly more than 100 cc. so that after transferring to the bulb *P* for final absorption of the remaining CO₂, the air returned to the graduated burette will be sufficient in amount to bring the level down upon the graduated portion of the burette for reading. The difference between this volume and the total of the several volumes is the total carbon dioxide present in the fusion.

By referring to Table XXI, there is found at the observed temperature and pressure the weight in milligrams of carbon in 1 cc. of CO₂ gas.¹ Multiply this weight by the number of cubic centimeters obtained in the above operation and the product equals the weight in milligrams of pure carbon. From this

¹ See also PARR, S. W., The weight of carbon dioxide with a table of calculated values, *Jour. Am. Chem. Soc.*, vol. 21, p. 237, 1909.

PER CUBIC CENTIMETER OF CO₂

Corrected for water vapor and barometer-glass scale

t/p	746	748	750	752	754	756	758	760	762	764	766	768	770
10	.5028	.5041	.5055	.5069	.5083	.5096	.5110	.5124	.5137	.5151	.5165	.5178	.5192
11	.5005	.5018	.5032	.5046	.5060	.5073	.5087	.5101	.5114	.5127	.5141	.5154	.5168
12	.4982	.4995	.5009	.5023	.5036	.5049	.5063	.5077	.5090	.5103	.5117	.5130	.5144
13	.4959	.4972	.4986	.4999	.5012	.5025	.5039	.5053	.5066	.5079	.5093	.5106	.5120
14	.4935	.4948	.4962	.4975	.4988	.5001	.5015	.5029	.5042	.5055	.5069	.5082	.5096
15	.4911	.4924	.4938	.4951	.4964	.4977	.4991	.5005	.5018	.5031	.5045	.5058	.5072
16	.4887	.4900	.4914	.4927	.4940	.4953	.4967	.4981	.4994	.5007	.5021	.5034	.5048
17	.4863	.4876	.4890	.4903	.4916	.4929	.4943	.4957	.4970	.4983	.4997	.5010	.5024
18	.4849	.4852	.4866	.4879	.4892	.4905	.4919	.4933	.4946	.4959	.4973	.4986	.4999
19	.4815	.4828	.4842	.4855	.4868	.4881	.4895	.4908	.4921	.4934	.4948	.4961	.4974
20	.4791	.4804	.4818	.4831	.4844	.4857	.4870	.4883	.4896	.4909	.4923	.4936	.4949
21	.4767	.4780	.4793	.4806	.4819	.4832	.4845	.4858	.4871	.4884	.4898	.4911	.4924
22	.4742	.4755	.4768	.4781	.4794	.4807	.4820	.4833	.4846	.4859	.4873	.4886	.4899
23	.4717	.4730	.4743	.4756	.4769	.4782	.4795	.4808	.4821	.4834	.4847	.4860	.4873
24	.4692	.4705	.4718	.4731	.4744	.4757	.4770	.4783	.4795	.4808	.4821	.4834	.4847
25	.4666	.4679	.4692	.4705	.4718	.4731	.4744	.4757	.4769	.4782	.4795	.4808	.4821
26	.4640	.4653	.4666	.4679	.4692	.4705	.4718	.4731	.4743	.4756	.4769	.4782	.4795
27	.4614	.4627	.4639	.4652	.4665	.4678	.4691	.4704	.4716	.4729	.4742	.4755	.4768
28	.4587	.4600	.4612	.4625	.4638	.4651	.4664	.4677	.4689	.4702	.4715	.4728	.4741
29	.4560	.4573	.4585	.4598	.4611	.4624	.4637	.4650	.4662	.4675	.4688	.4701	.4714
30	.4533	.4546	.4558	.4571	.4584	.4597	.4610	.4623	.4635	.4647	.4660	.4673	.4686
31	.4506	.4519	.4531	.4544	.4556	.4569	.4582	.4595	.4607	.4619	.4632	.4645	.4658
32	.4478	.4491	.4503	.4516	.4528	.4541	.4554	.4567	.4579	.4591	.4604	.4617	.4630
33	.4450	.4463	.4475	.4488	.4500	.4512	.4525	.4538	.4550	.4562	.4575	.4588	.4601
34	.4421	.4434	.4446	.4459	.4471	.4483	.4496	.4509	.4521	.4533	.4546	.4559	.4572
35	.4392	.4405	.4417	.4430	.4442	.4454	.4467	.4479	.4492	.4504	.4517	.4529	.4542

should be subtracted the weight of carbon found by running a blank in exactly the same manner, using one measure of the sodium peroxide instead of the fusion.

After subtracting the blank, the carbon remaining represents the total carbon present in the fuel. Divide this number by the weight of fuel taken and multiply by 100. The product is the per cent of carbon present in the sample taken.

Coals with calcium carbonate present should have the CO₂ in that combination determined and the total carbon factor corrected accordingly. Five grams of coal should be put into the flask and treated precisely as for a fusion. The amount of carbon found from the volume of CO₂ liberated is subtracted from the total carbon as obtained from the fusion. This of course is in addition to the CO₂ found in the blank determination in the Na₂O₂.

Hydrogen.—The hydrogen is determined by calculation as already discussed in Part I, page 49. At this stage in the development of the work it is well to transfer the factors involved to the unit coal basis. Calculate the B.t.u. for unit coal. Calculate also the percentage of total carbon present in the unit coal, exclusive of course of any carbon present as calcite. From the total carbon ($C \times 14,545$) in which C is the percentage of carbon in the unit coal. The remaining heat is due to the combustion of the available hydrogen. Divide this remainder by the accepted value for hydrogen $\left(\frac{H}{62,000}\right)$ in which H is the residual heat after subtracting the heat due to the combustion of the carbon.

Oxygen.—Assuming a value in the unit coal for nitrogen of 1.75 per cent, we would have the residual constituents, R consisting of oxygen and the hydrogen combined as H_2O represented by the expression $R = 100 - (C + H + N)$.

In the value thus found for R , the combined hydrogen would be one-ninth and the oxygen eight-ninths of that value.

The values thus obtained on unit coal are to be calculated back to the "dry" by multiplying each value by 1 minus the ash corrected for hydration and sulphur.

CHAPTER XXIV

FUEL GAS ANALYSIS

Introduction.—The types of fuel gases have already been discussed in Part I, pages 89 and 90. An examination of the constituents present in these various gases shows that while there are large variations in the percentage composition, the constituents themselves are quite uniform as to kind. For this reason it is possible and exceedingly convenient to assemble in one apparatus the individual units for making the several determinations. Moreover, portability is not an essential feature for such work, hence the development of what may be properly referred to as an enlarged Orsat for making a complete analysis of any of the various types of fuel gases.

Description of Apparatus.—The apparatus, Fig. 44, consists of two parts, the first being a graduated and a blank companion, burette, which assures measurements at atmospheric pressures, and an attached leveling bulb. By means of these the sample is measured before the analysis is begun and also after the removal of each constituent. The burettes and leveling bulb are filled with a saturated salt solution which may be slightly colored, if desired, with some inorganic salt as NiNO_3 , to aid in reading the graduations on the burette, *a*. The jacket surrounding these two burettes is filled with water slightly acidulated to keep it clear. The second part is a stand supporting seven absorption pipettes, one copper oxide furnace and one slow combustion pipette. These are connected to the measuring burette by means of a manifold of capillary glass tubing and stop cocks, this being divided into three parts, as is shown by the figure, to facilitate manufacture, assembling and, when necessity demands, repairing. All stop cocks through which gas is passed should have the plug or core bored at an angle, as they are then less apt to leak. All of the stop cocks in the apparatus should be kept well lubricated with a special stop-cock grease.¹ Care must

¹ WHITE, ALFRED H., "Technical Gas and Fuel Analysis," p. 17.

also be taken not to pull the reagents in the pipettes up into the stop cocks as this will cause them to stick; this is especially true of KOH and Pyrogallol, and if such a mistake is made the stop cocks must at once be carefully cleaned and greased. The absorption pipettes are the same as those used in the ordinary Orsat flue gas analysis outfits and have the chamber into which

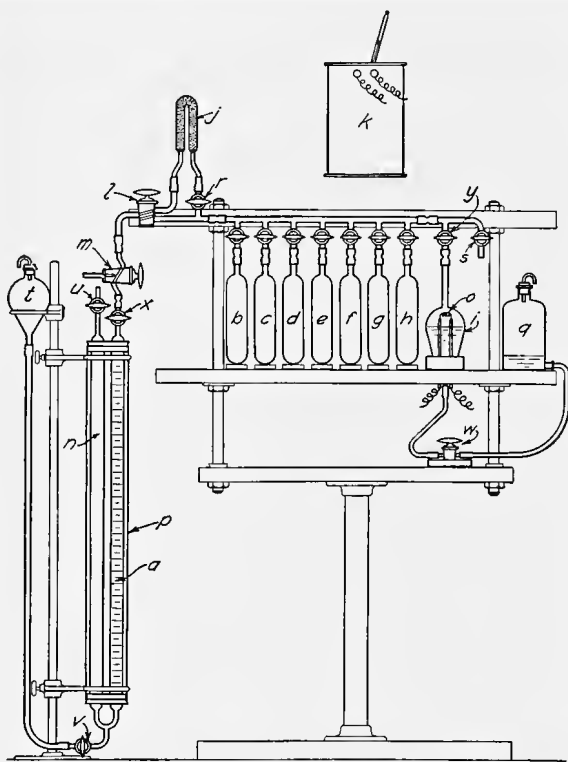

FIG. 44.—Modified Orsat apparatus.

the gas is drawn filled with glass tubes to increase the surface and obviate the necessity of shaking.

The so-called copper oxide furnace is an ordinary chromel wire resistance furnace, wound on an alundum core, insulated with sil-o-cel and contained in a metal jacket. It has been found that 40 ft. of No. 24 chromel wire makes a satisfactory heating ele-

ment. The current for such an element is taken from the 110-volt alternating-current lighting circuit which may be connected directly without danger of burning out the element. This, however, will heat the furnace higher than is desired and it is necessary to connect a lamp-bank resistance in series with the heating element in order to maintain the desired temperature. The lamp bank is not shown in the figure, but may be seen in the photograph, Fig. 22, page 96. The furnace is placed over the pyrex U-tube, *j*. The U-tube is filled completely with copper oxide that has been ground to pass through a 20-mesh sieve and has been caught on a 40-mesh sieve. The oxide is revived from time to time by passing oxygen through it while it is at the reactive temperature of 300°C.

The slow combustion pipette, *i*, is made from a 300 cc. pyrex Kjeldahl digesting flask. It is connected to the manifold with a small capillary tube which must be carefully sealed on so that the orifice is no larger than the bore of the tubing. This will cause the gas to enter the pipette in a small jet and eliminate the liability of explosive mixtures during the manipulation of the pipette. The bottom of the pipette is closed with a three-hole rubber stopper which accommodates, besides the outlet of the pipette, two glass tubes at the inner ends of which is sealed a platinum coil. This coil is placed about $\frac{1}{2}$ in. below and slightly to one side of the opening of the capillary tube. It is connected in series with a chromel sliding contact resistance (not shown in the figure). The outlet from the pipette connects, by means of rubber tubing and the stop cock, *w*, with the small aspirator bottle, *q*. Mercury is used in this part of the apparatus instead of salt water.

Oxygen and nitrogen are used during the procedure of the analysis. These are kept at hand in large aspirator bottles over water, and are connected permanently with the apparatus by means of rubber tubing. The stop cock, *s*, connects with the nitrogen bottle and *m*, with the oxygen bottle. The sample of gas is usually collected and stored over saturated salt water in a small aspirator bottle and is drawn from this into the burette, *a*, through a rubber tube connected to the stop cock, *x*, which has a key extension for the rubber tubing and is similar to the stop cock, *m*.

Manipulation and Description of Reagents.—Before beginning an analysis, make sure that none of the stop cocks leak or otherwise need attention, and that the level of the solutions in all of the pipettes is up to the mark. Next sweep the manifold and copper oxide tube thoroughly with nitrogen drawing it in through the stop cock, *s*, and expelling it through the stop cock, *x*. It is also well to have brought the copper oxide furnace up to the required temperature of 300° before the analysis is begun and to have made sure that the nitrogen enclosed in it is at atmospheric pressure. Otherwise due to expansion there will be a slight change in the reading on the burette, when the stop cocks, *l* and *r*, are opened during the analysis, which will probably be overlooked and which will make an error in the hydrogen determination. Having observed the above precautions and having the burette, *a*, filled with salt solution completely up to the stop cock, *x*, the sample bottle is connected with the stop cock, *x*, by means of a rubber tube that has been thoroughly flushed with the gas to be analyzed. A sample of slightly over 100 cc. is drawn into the burette. The companion tube, *n*, has been opened to the atmosphere and the solution in it is at the same level as in the bulb, *t*, which should be slightly below the level of the 100 cc. graduation on the burette, *a*. Without closing the stop cock, *x*, the rubber tube is disengaged from the sample bottle, but not from the stop cock, and the bulb, *t*, is raised until the solution in it and the two burettes are at the same level and at the 100-cc. mark in the burette, *a*. The stop cocks, *x* and *u*, are now closed and the burette, *a*, contains exactly 100 cc. of the gas at atmospheric pressure. Since all other parts of the apparatus are filled with the inert gas, nitrogen, and since all future volume readings during this analysis will be made at the same pressure, the contractions will all be on the basis of the 100-cc. sample at atmospheric pressure and will be in per cent by volume directly. It is assumed that the atmospheric pressure will not change during the analysis. No corrections need to be made on account of the gas being saturated with water vapor. During the analysis the leveling bulb, *t*, is held in the left hand and by being raised or lowered, the gas is forced into the various pipettes or drawn back into the burette, *a*. In measuring the sample during the analysis, the stop cock, *u*, is opened and with the aid of the leveling bulb,

the solutions in burettes, *a* and *n*, are brought to the same level. The stop cock, *v*, is now closed and the volume read on the burette, *a*. This volume is written down at once and the analysis continued by closing the stop cock, *u*, opening *v*, and with the aid of the bulb, *t*, forcing the sample into the next desired portion of the apparatus.

Now that the apparatus contains a sample of exactly 100 cc. of gas, the next step is the removal of the constituent carbon dioxide. The first pipette, *b*, contains about 150 cc. of 40 per cent KOH.¹ White specifies 25 per cent NaOH for the absorption of carbon dioxide, but in the author's laboratory it has been found that KOH is a faster reagent and also has a greater capacity for carbon dioxide. It may be used until it shows considerable carbonate precipitate and still seems to be as active as when freshly made. The stop cocks, *x*, *m*, *l*, and the one at the top of the pipette, *b*, are opened so that by raising the leveling bulb, *t*, the gas in burette, *a*, will be driven into the pipette. The gas is forced from *a* to *b* and back several times, usually five will be sufficient, until it shows no further reduction in volume. The difference between this final constant volume and the original 100 cc. will be the per cent of carbon dioxide in the sample. It might be well to note that if the gas contains hydrogen sulphide, it will also be removed by the KOH and thus give a slight error in the carbon dioxide value. Hydrogen sulphide may be determined, when in sufficient quantity, by passing the gas first into a pipette filled with a solution of arsenious acid.² In this case the removal of carbon dioxide would come second in the procedure.

Oxygen is next removed by passing the sample several times into the pipette, *c*, which contains an alkaline solution of pyrogallol, made by mixing equal volumes of 33 per cent KOH and 25 per cent pyrogallic acid.³ One volume of this reagent is able to absorb about eight volumes of oxygen. The reagent will deteriorate quite rapidly if exposed to the air and it is well to connect the secondary pipette with a small rubber balloon to eliminate deterioration in this manner. After removal of all the oxygen, the volume of the gas is taken. The difference between

¹ WHITE, ALFRED H., "Technical Gas and Fuel Analysis," p. 72, 1920.

² *Loc. cit.*

³ WHITE, ALFRED H., "Technical Gas and Fuel Analysis," p. 33, 1920.

this volume and the volume after removing the carbon dioxide is the per cent of oxygen in the sample of gas.

Oxygen may be removed from the gas with yellow phosphorus.¹ This is sometimes desirable especially when the percentage of oxygen is rather high, on account of the relatively small capacity of the pyrogallol. The phosphorus in the form of small sticks is placed in the pipette, instead of the glass rods, and is covered with water. On passing the gas to be analyzed into the phosphorus pipette, the oxygen unites with the phosphorus forming solid oxides of phosphorus. However, when phosphorus is used to remove oxygen, the gas must have been previously freed from ethylene and benzene, as these will poison the phosphorus and make it inactive. Phosphorus is considered a very good reagent for oxygen but its use in the apparatus in the author's laboratory has been rather unsatisfactory on account of its being affected by light, its ease of being poisoned and its slowness of reaction.

The sample of gas after removal of oxygen by means of the pyrogallol is passed into the pipette, *d*, which is filled with bromine water. This removes ethylene and any other unsaturated hydrocarbons that may be present. Before reading the new volume to determine the per cent of ethylene removed, it is necessary to pass the sample a few times into the KOH pipette to remove the bromine fumes and thus give the correct volume. The bromine solution is saturated with bromine and is maintained saturated by keeping a few drops of bromine in the bottom of the pipette at all times. As long as the solution is maintained in a saturated condition, it will never cease to function.

Benzene is removed by passing the sample into the pipette, *e*, which contains fuming sulphuric acid. This reagent will also remove any ethylene that is in the gas at this time and in some procedures is used for both ethylene and benzene, the two being, when determined together, considered as illuminants. The reagent used in this apparatus is the ordinary 20 per cent fuming sulphuric acid and it is considered active as long as it shows SO₃ fumes when the sample is forced into the pipette. These fumes must be removed from the sample of gas by means of the KOH

¹ WHITE, "Technical Gas and Fuel Analysis," p. 30, 1920.

pipette before the resultant volume is read for the same reasons that the bromine fumes were removed.

This concludes the absorption methods in the ordinary analysis and the next step is the determination of hydrogen and carbon monoxide by use of the copper oxide furnace, already described. It is assumed that this furnace is at a temperature of 300°C. and that the enclosed nitrogen is at atmospheric pressure this having been attended to at a previous time. The stop cocks, *l* and *r*, are turned to bring the U-tube, *j*, in series with the rest of the manifold and the gas sample is forced through the U-tube and into the pipette, *h*. This pipette is filled with saturated salt solution and does not necessarily need to be filled with glass rods as it merely acts as a reservoir for the gas sample. On passing the gas through the hot copper oxide, combustion of the hydrogen and carbon monoxide takes place, the former burning to water and condensing out, while the latter burns to carbon dioxide and remains in the sample but occupies the same space as did the carbon monoxide. Thus the contraction in volume is due entirely to the removal of the hydrogen from the sample of gas, and if the sample is passed back and forth through the copper oxide until its volume becomes constant, the contraction will give directly the per cent of hydrogen that was originally in the sample. As the reactive temperature of carbon monoxide with copper oxide is lower than that of hydrogen, it may be assumed that when all of the hydrogen has been removed, all of the carbon monoxide will be burned to carbon dioxide. After reading the volume and determining the percentage of hydrogen in the gas, sufficient nitrogen is drawn in through the stop cock, *s*, to completely sweep the tube, *j*, of any of the sample. The gas in the burette is placed at atmospheric pressure and the stop cocks, *l* and *r*, are returned to their original position. The volume of the sample which is now increased due to the added nitrogen is read and noted as "new volume." The sample is now forced into the pipette, *b*, several times to remove the carbon dioxide resulting from the burning of the carbon monoxide. The resultant volume is read and the difference between this volume and the last read or "new volume" gives directly the per cent of carbon monoxide that was present in the gas.

The sample of gas now contains presumably nothing but

methane, ethane and nitrogen, although there probably are instances where some of the higher paraffin homologues are present. The amounts of paraffins are determined by burning in an atmosphere of oxygen in the slow combustion pipette, *i*, the ignition being due to the electrically heated platinum coil, *o*. The mechanics of the determination are as follows: Store the sample temporarily in the pipette, *h*. Draw oxygen into the burette, *a*, through the stop cock, *m*, measure the volume at atmospheric pressure and then force it into the pipette, *i*. From 150 to 200 cc. of oxygen is usually necessary, which means that a second burette full must be forced into the pipette *i*. The approximate volume of oxygen needed can be estimated by knowing previously something concerning the amounts of methane and ethane present in the sample. The sample is next drawn back into the burette, *a*, and placed under slight pressure by putting the bulb, *t*, in the upper holder as shown in the figure. The level of the mercury in the pipette, *i*, will be below the tips of the glass rods, as shown in the figure. The stop cock, *w*, is open and the mercury level in the bottle, *q*, is slightly lower than in the pipette, *i*, thus giving a slight vacuum in the pipette. The stop cock, *y*, in the manifold, leading to the pipette, *i*, is closed. The electric current is next passed through the platinum coil heating it to a bright-red or almost white heat. It is now time to admit the sample from the burette. Carefully open the stop cock, *y*, slightly, and do not let go of it, thus controlling the flow of gas into the pipette. It should burn at once with a small luminous jet from $\frac{1}{4}$ to $\frac{3}{4}$ in. in length and not directed upon the platinum coil. Watch carefully the flow of the gas from the burette, *a*, and when the burette is full of water, close the stop cock, *y*, from which the hand has not been removed. Immediately turn off the electric current. If the above directions are not carefully followed a dangerous explosion may occur when the attempt is made to burn the paraffins. The hydrocarbon gas, C_nH_{2n+2} , in the sample has burned to water and carbon dioxide. The water has condensed out and may be seen on the surface of the mercury. It is forced up the capillary tube when the resultant gas is withdrawn from the pipette, *i*, and finds its way, usually, into the pipette, *h*, by settling into the vertical tubing above the stop cock until that stop cock is turned

during the next analysis. No special attention is given to the elimination of the water from the pipette, *i*, but it is the usual practice to bring the level of the mercury up to the stop cock, *y*, after each determination, and thus the water in the pipette, *i*, is maintained at a minimum.

It is now necessary to measure back the volume of gas in the combustion pipette and determine the carbon dioxide that it contains. First, place the level of the mercury in the bottle, *q*, above that in the pipette, *i*, thus preventing the salt solution in the burette, *a*, being pulled over into the pipette, *i*, when the stop cock, *y*, is opened. Measure the resultant gas, pass it into the pipette, *b*, to remove the carbon dioxide and measure the volume a second time. From the readings taken during the procedure, as just described, four values are available. These are: (1) The volume of the gas sample burned. (2) The volume of oxygen taken. (3) The volume of the resultant gas after combustion. (4) The volume of carbon dioxide in the resultant gas. The contraction, due to the condensation of water, is obtained by subtracting (3) from the sum of (1) and (2). By substituting these values in the formula $V = \frac{2C - CO_2}{3}$ it is possible to calculate the volume of the paraffins present in the sample. And by substituting in $n = \frac{CO_2}{V}$, the index of average composition of the paraffins is obtained. The derivation and application of these formulas is more fully discussed in Part I, page 99.

The sum of the percentages of the constituents so far determined should not be 100. The difference between their sum and 100 therefore is taken as the percentage of nitrogen in the original sample. This nitrogen value since it is obtained by difference, must of course carry all of the errors of the several determinations. Experience would seem to indicate, however, that these are small in amount.

Of the seven absorption pipettes only five are used in the ordinary analysis. The two extra pipettes are included in the apparatus for additional reagents that may be needed in case of analyzing special gases, as for example, it may be desired to fill a pipette with arsenious acid for the removal of hydrogen

sulphide, or the gas may contain acetylene which can be removed directly after oxygen by passing into a pipette filled with ammoniacal silver chloride.¹ The ammonia fumes must be removed by

passing the gas into a pipette of weak sulfuric acid before the reading is taken. The desirability of a phosphorus pipette has previously been discussed. In case the two extra pipettes are not filled with special reagents, it is well to fill them with saturated salt solutions as they may often be used as storage reservoirs for samples of gas to be analyzed.

The Determination of Sulphur in Gas.—Gas regulations usually prescribe the limit for hydrogen sulphide as well as for total sulphur.

In gas works practice, a ready test for *hydrogen sulphide* is used in the shape of filter paper moistened with lead acetate. The method has quantitative possibilities of sufficient accuracy for indicating the completeness of purification in the manufacturing process. The Bureau of Standards, in Circular 32, recommends the following as a standard form of specification: "The gas shall be considered to contain not more than a trace of hydrogen sulphide if a strip of white filter paper moistened with a solution containing 5 per cent by weight of lead acetate is not distinctly darker than a second paper freshly moistened with the same solution after the first paper has been exposed to the gas for one

FIG. 45.—
Hydrogen
sulphide
indicator.

minute in an apparatus of approved form through which the gas is flowing at the rate of approximately 5 cu. ft. per hour, the gas not impinging from a jet upon the test paper." An apparatus for this test is shown in U. S. Bureau of Standards Circular 48, p. 118, and may easily be made with an ordinary 8 in. cylindrical gas chimney of about $1\frac{3}{4}$ in. in diameter with stoppers at each end. A 5-ft. burner jet is installed above, and the pillar of an ordinary gas burner below. Arrangements for spreading the gas at the intake and a support for the test paper are shown in Fig. 45. A hardened filter paper with smooth surface is preferred. It should be moist and suspended vertically midway between the watchglass below and the cork above.

¹ WHITE, ALFRED H., "Technical Gas and Fuel Analysis," p. 85, 1920.

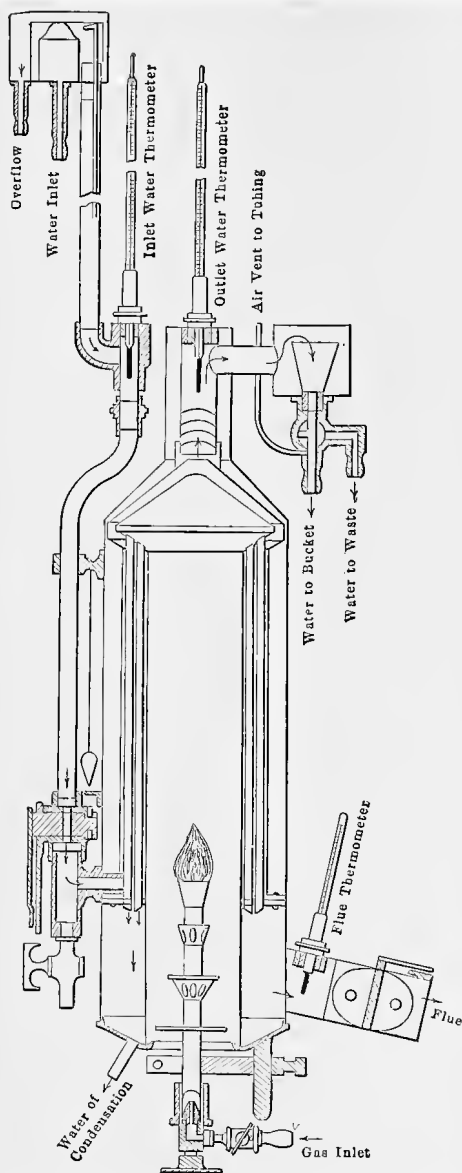

FIG. 46.—Junker calorimeter showing details of construction.

The *total sulphur* in gas is determined either by the Referee's apparatus or by the Drehschmidt method. The former is described in the Bureau of Standards Circular 48 and is probably more frequently employed in gas works practice. The two methods are similar, differing chiefly in the mechanism employed. The Drehschmidt method is made use of in the author's laboratory and consists of 3 wash bottles connected to the vacuum system or a water jet pump. The gas is burned under a trumpet tube which is connected to the washing train for delivering the products of combustion to the alkaline wash bottles which have a 5 per cent solution of Na_2CO_3 with a few drops of bromine water or a small amount of Na_2O_2 added to each bottle. The burning of $2\frac{1}{2}$ feet of gas is sufficient for a test and the burner should consume about 1 cu. ft. per hour. The meter, barometer, and thermometer readings are taken at the beginning and ending of a test. The solutions are transferred to a beaker, made slightly acid with HCl and reduced in bulk by evaporation if necessary. Add about 1 cc. excess of normal acid and determine the sulphur by means of the photometer or gravimetrically in the usual manner.

Direct Determination of Heating Value.—The calorimeters most frequently used in determining the heating value of fuel gas are of the continuous flow type. The first instrument designed in 1893 by Hugo Junkers¹ with minor changes is the standard instrument at the present time. The general installation has already been shown in Fig. 21. A cross section here given in Fig. 46 will be of assistance in following the operation of the instrument.

A Bunsen burner delivers the heat from the gas into the combustion chamber. Since it is essential that all of the heat be extracted from the spent gases, their discharge must be at the bottom of the apparatus instead of at the top, the gases in the downtake being heavier than those in the combustion chamber. The principle involved is therefore similar to that of a siphon for liquids. In order to secure an even flow of water through the instrument, a constant head is maintained by means of an overflow cup. On the way down, the water passes the inlet thermometer and is admitted near the bottom of the instrument

¹ *Journal fur Gasbel*, Vol. 36, p. 81 (1898).

through a regulating valve. The water flowing upward collects in the neck of the heater and passes the outlet thermometer into a second constant overflow cup from which it may be directed either to the weighing bucket or to the waste. The water of condensation forms only in the down-take passageways and collects at the bottom where an outlet is provided.

Operation of the Junker Calorimeter.—The directions for operating the calorimeter as prescribed by the technical committee of the American Gas Institute are essentially as follows:

Connect the meter to the governor and the governor to the burner with short pieces of rubber tubing, or with flexible metal tubing having coupled ends.

The calorimeter should be set up in a quiet, light and well ventilated room or cabinet, which is free from draughts and in which the temperature can be maintained constantly at not less than 60°F. The room should be provided with a sink and large shallow overhead covered tank, from which the water supply can be taken. Should the tank capacity be small and not hold enough water for a prolonged series of readings, a small gas water heater may be employed to bring the water to approximately the room temperature. It is desirable to use water that is clear and free from suspended matter in the calorimeter, therefore, a filter should be installed in the water supply line before it enters the overhead tank.

If only a single test is desired, gas may be taken from the house piping, but if an average value is required, a small gas holder, or averaging tank, should be used, and the gas flowing into the holder adjusted to a rate of flow to just fill it in the time during which the sample is to be taken. Care should be taken to have a short service to this holder in order that an average sample of gas may be obtained, and if the sample be taken from a line on which there is no considerable consumption, see that this line is thoroughly purged before sampling. It is recommended that the gas be metered at a pressure not to exceed two inches of water; if this is not obtainable, it is advisable to insert a holder or diaphragm governor in the supply line to reduce the pressure to within this limit.

Make water connections with rubber tubing, being careful not to cramp the tubing. To avoid air currents caused by the

movement of the observer's body, set up the calorimeter so that the water supply and waste may be easily adjusted and that all temperatures may be readily observed. Lead the outlet water to a waste funnel supported a little above the top of the copper or glass container used in collecting the water, so that the water can be shifted from the funnel to the container and back without spilling.

Set up the gas meter facing the observer and level it carefully. Then adjust the water level of the meter, both inlet and outlet being open to the air. If the meter has been filled with fresh water, the gas must be allowed to burn at least two hours before making a test. When the water in the meter is saturated with gas, 20 minutes should be sufficient.

Fill pressure regulator with water, about $\frac{3}{4}$ full, then connect it to the calorimeter burner. Metallic tubing is preferable, but when rubber tubing is used to connect meter, pressure regulator, and burner, connections should be as short as possible, and should be saturated with the gas.

Turn on the gas and allow it to burn for five to ten minutes with the burner on the table. Shut off the gas at burner and watch the hand on the meter for leakage. Be sure that all leaks are stopped before attempting to make a test. Start water running through the calorimeter at a rate of about 3 pounds per minute. Then regulate the gas to flow at the rate of 4 to 7 feet an hour, as may be found by experiment to give the highest result with the gas to be tested, admitting enough air through the burner so that the flame shows a faint luminous tip, then insert the burner as far up into the combustion chamber as the bracket permits, and observe again the condition of the flame to see that it is all right, using a mirror.

The excess of air passing through the calorimeter is controlled somewhat by the position of the damper. Some experimentation may be necessary. Operate the calorimeter until a thermal balance is established on the inlet and outlet water thermometers. Start with the damper closed, then open slightly, observing carefully the outlet thermometer. When this thermometer reads at a maximum—or in other words, when the greatest rise in temperature is given to the water, which is presumable passing through the calorimeter uniformly—the damper is in approxi-

mately the correct position for the amount of gas being burned, and the excess air necessary for perfect combustion is at a minimum.

Water should be regulated so that there is a difference between the inlet and outlet temperatures of about 15°F. The temperature of the inlet water should vary but little when an overhead tank is used and the water maintained at room temperature. Be sure that both overflows are running.

Before making the test, the barometer, temperature of the gas at the meter, temperature of room and temperature of exhaust products should be recorded. It is desirable to have the temperature of the inlet water and temperature of exhaust products as nearly as possible at room temperature, in order to establish more nearly a thermal balance—the difference in these temperatures should never exceed 5°.

Next allow the gas to burn in the calorimeter until a thermal balance is established, or until there is the least change in the inlet and outlet waters. The condensed water should also commence to drip showing an equilibrium status within the calorimeter.

The test may now be started by shifting the outlet water from the funnel to the container just as the large hand on the meter passes the zero point. Readings are then made of the inlet and outlet thermometers, making the readings as rapidly as the observer is able to record them during the consumption, preferably of two-tenths of a cubic foot of gas. At least ten readings should be made of both inlet and outlet water temperatures. Water is again shifted from the container to the waste funnel as the hand passes the zero point the second time. Water is then weighed or measured. The uncorrected heating value per cubic foot is obtained by multiplying the difference of the average of inlet and outlet temperatures, by the number of pounds of water and by dividing by two-tenths. This quantity is divided by the correction factor for barometer and temperature, obtainable from the tables in the Appendix, to give the heating value at 30 inches pressure and 60°F. The weight or contents of the container should be obtained while the inside is wet. This may be done by filling it with water, emptying and shaking for about five seconds in an inverted position. This will do away with

any correction where several consecutive tests are required with the same container.

A second, and perhaps a third test is advisable, and these should be made without disturbing the existing conditions, provided all readings are within the above prescribed limits. In practice the operator should get consecutive results on the same holder of gas within ten (10) B.t.u.'s. Under such conditions an average of the results may safely be taken. The water of condensation should be caught in a 50 cc. graduate so that calculation can be made for the net heating value if desired. It is better to collect the condensate from a total of 1 cu. ft. for making the estimate. The latent heat of vaporization for water at the initial temperature of the gas and air is taken as 0.600 Calories, hence the number of cubic centimeters of condensed water from 1 cu. ft. of gas multiplied by 0.600×3.968 will equal the B.t.u. to be subtracted from the total observed values as given by the calorimeter for the net B.t.u.

CHAPTER XXV

THE ANALYSIS OF FLUE GASES

Reagents.—The analyses to be made in this course will be performed with what is known as the “Orsat apparatus,” Fig. 47. This is made of a jacketed 100-cc. gas burette and leveling bottle permanently connected by a capillary tube having four side arms to three pipettes and to the open air. The end of the

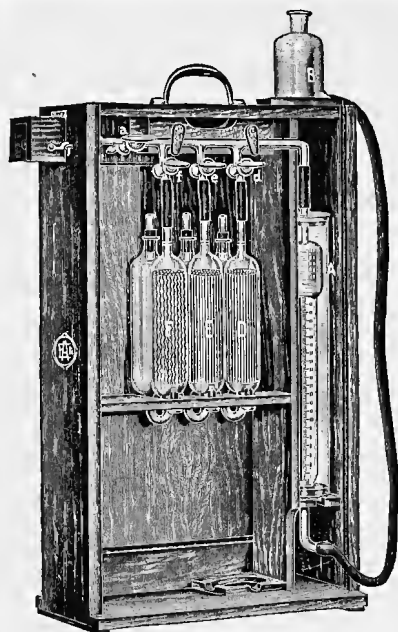

FIG. 47.—Orsat apparatus.

capillary tube extends outside the case for convenience in taking a sample of gas. The pipettes are provided with reagents, as follows:

1. Potassium hydroxide, for absorption of carbon dioxide, CO_2 . Strength of solution, 40 per cent. One cubic centimeter absorbs 40 cc. of carbon dioxide.

2. Potassium pyrogallate for absorption of oxygen, O_2 . Equal volumes of 33 per cent KOH and 25 per cent pyrogallic acid solutions are mixed together. One cubic centimeter will absorb 8 cc. of oxygen.

3. Cuprous chloride for the absorption of carbon monoxide, CO. A solution of cuprous chloride is prepared by dissolving Cu_2Cl_2 in hydrochloric acid sp. gr. 1.12 in the ratio of 15 grams of the salt to 100 cc. of acid. The activity of the solution depends on the presence of copper in the cuprous form. If pure, the solution would be colorless. It turns green upon oxidation. It should be kept from the light and occasional additions of copper wire or turnings made to the accessory pipette or the stock bottle.

Analysis of Atmospheric Air.—Adjust the reagent in each pipette by drawing the solution up into the capillary tube to the mark just below the rubber connection. Fill the jacketed measuring burette with water out to the end of the capillary tube, then draw in a little over 100 cc. of air by opening the outer vent and lowering the leveling bottle. Next, slowly raise the leveling bottle until the meniscus gives a reading of exactly zero, and the level of the water in the burette is just equal to that in the leveling bottle.

(a) *Oxygen.*—Close the pinch cocks on all vents and open the one on the second pipette, the one containing potassium pyrogallate; now raise the leveling tube slowly, thus forcing the air into the pipette. When the water has reached the 100-cc. mark on the burette, shut the pinch cock and allow to stand for 5 min. Now open the cock and run the gas back into the burette by lowering the leveling bottle. Watch the surface of the pyrogallate solution, and as it approaches the mark slow up the flow of gas—by careful manipulation of the leveling bottle the solution can be brought just to the mark and then shut off, giving much more delicate adjustment than can be obtained by manipulation of the pinch cock alone. It is very important that none of these solutions get above the pinch cock, as the potassium hydroxide in them interferes with the carbon dioxide determinations in subsequent samples.

Repeat the absorption for 3 min. and read again. The contraction in volume is due to absorption of oxygen. Calculate the percentage on the sample taken.

The Analysis of Respired Air.—The apparatus should be in adjustment after the preceding experiment. Take a long breath and hold in the lungs for some time, then blow it into one of the rubber balloons. Attach this to the outer vent of the apparatus and draw in a sample in excess of 100 cc. Now close this pinch cock and open the one at right angle, to the air; then, by raising the leveling bottle slowly, bring the surface of the water to the zero mark and close the cock opening to the air.

(a) *Carbon Dioxide.*—Always absorb the carbon dioxide first bringing the gas into the first or potassium hydroxide pipette. Allow it to stand for 5 min. and repeat for 3 min. The contraction is due to carbon dioxide—determine its percentage.

(b) *Oxygen.*—Determine oxygen as in the case of atmospheric air. The difference between the total contraction and the first one is due to oxygen. Compute the percentage.

(c) *Nitrogen.*—This is determined by difference.

$$100 - (\text{CO}_2 + \text{O}_2) = \text{N}_2$$

Flue Gas.—All determinations of the constituents of flue gas are carried out as described above for “Respired Air.”

Carbon monoxide is determined after oxygen by means of the third pipette, allowing the gas to stand for 8 min. In calculating nitrogen, the amount of CO is of course taken into consideration.

CHAPTER XXVI

ANALYSIS OF BOILER WATERS

Normal Solutions.—If the reaction between one solution and another can be gaged exactly as to the “end point,” that is, if that point can be noted where an exact balance exists between the two reacting substances, we may make use of these solutions as media for making chemical measurements, just as a mechanic uses a foot rule for measuring lengths. Given, therefore, a solution of known value, that is, a standard solution, and a reaction where the end point or chemical equilibrium can be made visible to the eye by any means, we have a method which can be used to measure other solutions of unknown value. When a standard solution has its chemical value made up in terms of the molecular weight of the substance in grams per liter, it is called a molal solution. It is more convenient, however, to make up such solutions on the basis of the hydrogen equivalent of the part of the molecule concerned, in order to avoid the necessity of multiplying or dividing by two where ions of different valencies interact. Thus,

$2\text{HCl} + \text{Na}_2\text{CO}_3 = 2\text{NaCl} + \text{H}_2\text{CO}_3$ would call for two molecular quantities of HCl and one of Na_2CO_3 or one of HCl and $\frac{1}{2}$ of Na_2CO_3 . Again,

$\text{HCl} + \text{Na}_2\text{CO}_3 = \text{NaCl} + \text{NaHCO}_3$ would call for one full molecular quantity of HCl and one-half of the molecular value for the Na_2CO_3 . By common agreement the single hydrogen equivalent has been adopted as the basis, and solutions of this kind are called *normal* solutions. Hence, a normal solution of the first substance, HCl, has exactly 36.46 grams per liter. A normal solution of the second has exactly 53.00 grams or one-half of the molecular weight, 106.0, of sodium carbonate per liter. Where solutions of less strength are needed, tenth or hundredth normal solutions are used, expressed thus: $\frac{\text{N}}{10}$ or $\frac{\text{N}}{100}$

Thus, $\frac{N}{10}$ sodium carbonate has 5.300 grams of the pure substance per liter and each cubic centimeter contains 0.0053 gram of the alkali.

It is important that the full significance and value of the processes involving normal solutions be well understood at the outset of the work. The preliminary experiments following will help to this end.

EXERCISE I

Standard Sodium Carbonate.—The preparation of $\frac{N}{10}$ sodium carbonate solution is carried out as follows:

Clean and dry a porcelain crucible or small porcelain dish, then ignite it lightly and cool down to room temperature, putting into the desiccator at about 150°. Weigh accurately and add about 6 grams, more or less, of pure, dry sodium carbonate. Raise to a red heat, short of melting, and cool in a desiccator. Counterpoise upon the balance in such a manner that by removing with a clean knife blade or spatula the excess of material, there shall remain in the crucible exactly 5.300 grams of the carbonate. Empty the carbonate into a No. 3 beaker and add 50 or 100 cc. of distilled water. Rinse out the crucible also a number of times, adding the washings to the beaker. After solution of the carbonate is complete, pour the contents of the beaker into a liter measuring flask. Rinse out the beaker thoroughly, transferring the washings to the flask and make up finally to the mark. The temperature of the water employed for making up to volume should not exceed 20°C. Stopper and mix by shaking until an absolute certainty of uniform distribution of the solution is attained. If the sodium carbonate is pure and the proper care in regard to transferring, mixing, temperature, etc., has been observed, we should now have a strictly $\frac{N}{10}$ solution. To test its accuracy, obtain from the instructor some of the ready prepared $\frac{N}{10}$ hydrochloric acid solution and proceed as follows.

Measure about 20 cc. of the sodium carbonate from a burette into a clean beaker. Add about 20 cc. of water and 2 drops of

methyl orange solution. Titrate very slowly with $\frac{N}{10}$ hydrochloric acid from a burette. Add acid drop by drop until the yellow turns to an orange color. More acid will make the solution pink, but this is too far—the intermediate orange tint denotes neutrality. More accurate results will be obtained if the solutions are titrated back and forth until one drop of either solution will change the color of the indicator. Repeat this titration three times and average the results. The quantity of acid required should not vary from the solution taken by more than 0.1 cc. If there is a greater difference than this, the strength of the sodium carbonate solution may be calculated from the known hydrochloric acid solution. This correction is known as the $\frac{N}{10}$ factor. The factor must be taken into consideration whenever the sodium carbonate solution is used. The exactly $\frac{N}{10}$ solutions are much to be preferred where a large number of determinations are being made. What applies to the sodium carbonate solution is equally true with all standard solutions that are used. From the $\frac{N}{10}$ sodium carbonate solution make a $\frac{N}{50}$ sodium carbonate solution.

EXERCISE II

Standard Sulphuric Acid.—Prepare a $\frac{N}{10}$ solution of sulphuric acid by means of the $\frac{N}{10}$ Na_2CO_3 solution as follows:

Measure about $3\frac{1}{2}$ cc. of pure concentrated sulphuric acid into a flask containing 1,050 cc. of distilled water. Mix thoroughly and fill a 50-cc. burette with the solution. Measure 20 cc. from the burette into a clean beaker, add about 20 cc. of water and 2 drops of methyl orange. Titrate slowly with $\frac{N}{10}$ sodium carbonate solution from a burette until the end reaction is shown by the first change of color from pink to orange. Repeat the titration as before, being careful to note the correct color for the

end point. The acid solution is probably too strong. If the titration with $\frac{N}{10}$ sodium carbonate requires, say, 21 cc. instead of 20 cc., then in such case 20 cc. of acid would need to be diluted to 21 cc. to make an exact balance to the alkali solution. Similarly 200 cc. would need to be diluted to 210 cc. and the dilution for any amount would be indicated by the proportion

$$20 : 21 :: 1,000 : x$$

Hence, in the above example, measure an exact 1,000 cc. of the trial acid and add 50 cc. of pure water to it. Test the accuracy of the resulting solution with $\frac{N}{10}$ sodium carbonate as before.

EXERCISE III

Determination of Sulphur.—(Consult also the description for the determination of sulphur under "Sulphur Determinations," page 174).

Measure out 10 cc. of the $\frac{N}{10}$ sulphuric acid solution and make up to 100 cc. Measure carefully 10 cc. of this solution into a 100 cc. cylinder. Add 25 cc. of the NaCl solution described on page 178 and make up to the 100 mark, pour into an Erlenmeyer flask and add about 0.2 to 0.4 gram of special barium chloride crystals (BaCl_2) and shake thoroughly. Let stand for 5 to 20 min. with occasional shaking. Read the depth of liquid in the photometer tube at which the light completely disappears. Repeat the readings two or three times. If the column is less than 60 or more than 160 mm. in depth, reject the test and start anew using double or half the quantity of solution under test, making up to 100 cc. in each case as before.

In Chapter XXII, page 176, will be found a curve on which is indicated the number of grams of sulphur per 100 cc. of solution corresponding to the various heights. Calculate the weight of sulphur indicated to sulphuric acid. Note that the actual amount of the $\frac{N}{10}$ solution taken for the test is 1 cc.

One cubic centimeter of $\frac{N}{10}$ sulphuric acid has what weight of acid present?

How much sulphur?

What would be the equivalent amount of hydrochloric acid?
Sodium carbonate? Calcium carbonate?

EXERCISE IV

Standard Calcium Chloride and Soap Solutions.—Measure from a burette into a clean No. 2 beaker 40 cc. of $\frac{N}{10}$ hydrochloric acid. What equivalent does it contain in terms of sodium carbonate? What equivalent in terms of calcium carbonate? Weigh carefully 0.210 gram of pure calcium carbonate powder and add it to the 40 cc. of $\frac{N}{10}$ hydrochloric acid. Cover with a watch glass and heat for a few minutes till all action has ceased. Transfer to a liter flask. Wash out the beaker thoroughly with distilled water, transferring the washings to the flask. Make up to the mark and mix thoroughly by shaking. Allow the contents to stand quietly until all undissolved material has settled to the bottom. Siphon off half or more of the clear solution into a suitable flask and label "STANDARD CALCIUM CHLORIDE SOLUTION." Since 1 cc. of a $\frac{N}{10}$ solution is equivalent to 1 cc. of any other $\frac{N}{10}$ solution, we have in the above solution 40 cc. of a $\frac{N}{10}$ CaCl₂ solution. Although calcium carbonate is not soluble in water, the 40 cc. of $\frac{N}{10}$ calcium chloride is equivalent to the amount of calcium carbonate in 40 cc. of a theoretical $\frac{N}{10}$ solution of calcium carbonate. Since in 1 cc. of a $\frac{N}{10}$ solution of calcium carbonate there are 0.005 gram of calcium carbonate, in the 40 cc. of hydrochloric acid solution or the liter of solution there are 0.2 gram of calcium carbonate. The standard calcium chloride solution, therefore, has a value of 200 parts per million in terms of calcium carbonate.

The standard soap solution is prepared by dissolving 10 grams of castile soap in 100 cc. of 80 per cent alcohol. After standing for several days it is further diluted with 70 per cent alcohol to a point where 5 or 6 cc. of it as measured from a burette will produce a permanent lather when added as directed below to 20

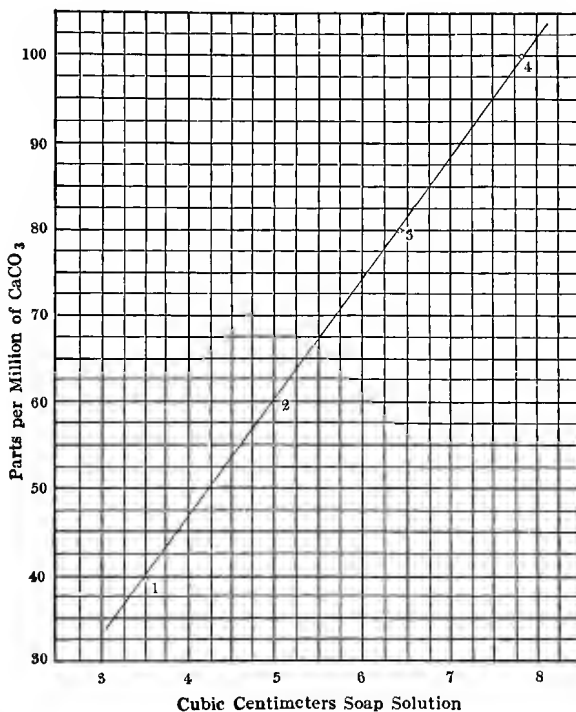

FIG. 48.—Development of the curve for a standard soap solution with the points located as follows:

- Point No. 1, using 10 cc. CaCl₂ sol.
- Point No. 2, using 15 cc. CaCl₂ sol.
- Point No. 3, using 20 cc. CaCl₂ sol.
- Point No. 4, using 25 cc. CaCl₂ sol.

cc. of the standard calcium chloride solution. This will require usually a dilution up to 900 or 1,000 cc.

Standardization of the Soap Solution.—Measure 20 cc. of the standard calcium chloride solution into a 250 cc. glass-stoppered bottle and add 30 cc. of distilled water. Run in from a burette

the standard soap solution 0.4 or 0.5 cc. at a time, shaking the bottle vigorously after each addition. Lay the bottle on its side after each shaking and note if the lather remains. The end point is taken where the lather remains over the entire surface of the water for 5 min. after shaking. Make three tests of the standard calcium chloride solution as above prepared. Repeat the process, using 10 cc. of the calcium chloride solution and making up to the same volume (addition of 40 cc. water) as before. By thus establishing a number of points as for 10, 15, 20 and 25 cc., in which the required soap solution has been determined, a curve for the strength of the soap solution is developed as illustrated in the chart, Fig. 48.

The hardness of a water is due to any mineral constituents in solution other than compounds of sodium, potassium, ammonium, etc., members of the first or soluble group. Upon the addition of soap to a hard water there are formed insoluble soaps of calcium, magnesium and iron, which are precipitated in curdy granules. When all of these constituents are precipitated the water is soft. It is this action of soap which permits of its use in a standard solution for measuring the total hardness.

EXERCISE V

Determination of Calcium Sulphate in Water.—Get a bottle of unknown *A* for analysis. Add 25 cc. to a clean beaker with a pipette, then run in 10 cc. of $\frac{N}{10}$ sodium carbonate solution. Boil for 5 min. on a sand bath, then filter into a clean beaker. Wash well with hot water, saving all the washings until the liquid leaving the funnel is neutral to litmus paper. Now add 2 drops of methyl orange to the filtrate and washings and titrate with $\frac{N}{10}$ hydrochloric acid.

The equation representing the reaction between sodium carbonate and calcium sulphate is

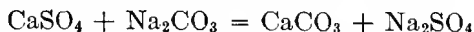

Since the titrated sodium carbonate is the balance of the 10 cc. remaining unchanged after the reaction has taken place, the difference between this amount and the 10 cc. originally added

represents the amount of sodium carbonate taking part in the reaction, and from this, remembering always the equivalent of normal solutions, compute the weight of calcium sulphate present. Since a 25 cc. sample was taken, how many *grams per liter* did the solution contain? How many parts per million? How many grains per U. S. Gallon?¹

Calculate also the lime, in grains per gallon, equivalent to the calcium sulphate present. Calculate also the equivalent of calcium carbonate in grains per gallon corresponding to the sulphate ion present. From the amount of hydrochloric acid used, calculate the sodium chloride (NaCl) formed.

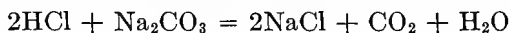

Perform all these calculations in the note book for inspection and reference.

EXERCISE VI

Excess or Free Carbon Dioxide.—By this is meant the carbon dioxide held in solution by the water. It is not scale forming material, but in water treatment it behaves as so much temporary hardness, and the amount present must be determined in order to gage correctly the quantity of reagent required in the treatment. The “excess” carbon dioxide is readily taken up by calcium hydroxide, $\text{Ca}(\text{OH})_2$, forming calcium carbonate; or by sodium carbonate, forming sodium bicarbonate. So long as there is present free carbon dioxide, it acts toward phenolphthalein as acid, decolorizing the same. The first excess of Na_2CO_3 beyond the point of absorption of the CO_2 is denoted by a pink coloration of the indicator. *

Procedure.—With the graduated cylinder measure 200 cc. of the water into a No. 3 (350-cc.) beaker. Add a few drops of phenolphthalein as indicator and titrate to the end point with $\frac{\text{N}}{50}$ sodium carbonate free from bicarbonate. The number of cubic centimeters used times 5 represents the equivalent or excess of CO_2 in parts per million, but measured in terms of calcium carbonate.

¹ Milligrams per liter or part per million $\times 0.0583 =$ grains per U. S. gallon. See p. 122.

EXERCISE VII

Total Alkalinity and Temporary Hardness.—Temporary hardness is due to the calcium, magnesium, and iron held in solution in the form of bicarbonates. They are readily broken down by dilute acids and, until so destroyed, are alkaline towards methyl orange indicator.

Procedure.—Measure 200 cc. of the water into a No. 3 beaker, add a few drops of methyl orange and titrate with $\frac{N}{10}$ sulphuric acid. From the number of cubic centimeters used can be calculated the equivalent in parts per million of temporary hardness measured in terms of calcium carbonate. Note that to calculate the value in cubic centimeters per liter we would need to multiply the titration by five. The equivalent value for $\frac{N}{10}$ sulphuric acid in terms of calcium carbonate is 0.005 gram per cubic centimeter of solution. Hence, five times the number of cubic centimeters per liter would represent the calcium carbonate in milligrams per liter. That is, 25 times the titration number represents milligrams per liter or parts per million of calcium carbonate equivalent.

NOTE.—If under Exercise X below sodium carbonate is found to be present as negative hardness, the temporary hardness is equal to the total alkalinity minus the negative hardness. If there is no negative hardness the temporary hardness is equal to the total alkalinity.

EXERCISE VIII

Magnesia.—Use the solution from Exercise VII above. Cover the beaker with a watch glass, boil for 15 min., add 50 cc. of saturated lime water and allow to stand at near the boiling temperature for about 15 min. Filter into a 250-cc. flask, wash with boiled distilled water and add water so that the volume at room temperature will be 250 cc. Titrate 100 cc. with $\frac{N}{10}$ sulphuric acid, using the methyl orange indicator. Make at the same time the same determination, using pure distilled water in place of the water analyzed. The difference between the two titrations is the amount of sulphuric acid which would have been neu-

tralized by the calcium hydroxide, which has precipitated the magnesium from the water. Since the amount titrated, 100 cc., is equal to two-fifths of the 250 cc., it must also be equal to two-fifths of the original 200 cc. Then the difference between the titrations multiplied by $(\frac{5}{2}) 5 \times 5$ equals the equivalent in parts per million of the magnesia in the water measured in terms of calcium carbonate.

NOTE.—Because of the solubility of magnesium carbonate in the presence of alkali bicarbonates, it is necessary to precipitate the magnesium as hydroxide. In water treatment, therefore, the magnesium bicarbonate requires double the amount necessary to simply bring it to the carbonate stage (see p. 125, Part I).

EXERCISE IX

Permanent Hardness.—Boil in a porcelain dish 500 cc. of the water for about 10 min. and add 25 cc. of $\frac{N}{10}$ “soda reagent” (equal parts of sodium hydroxide and sodium carbonate) and boil further to about $\frac{1}{2}$ volume. Filter, wash and make up to 250 cc. Titrate 100 cc. of this solution with $\frac{N}{10}$ sulphuric acid, using methyl orange as an indicator. The amount of original water used is then 200 cc. since the 100 cc. used is two-fifths of the 250 cc. and consequently two-fifths of the 500 cc. The difference between this titration and the amount of acid equivalent to 10 cc. $\frac{N}{10}$ soda reagent multiplied by (5×5) represents the equivalent of permanent hardness in parts per million measured in terms of calcium carbonate. Calculate also the amount in parts per million of the sodium sulphate formed by the reaction and refer the result for use under Exercise XIV.

In the reaction, as with “soda reagent” for example

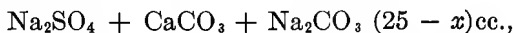
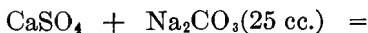

it is seen that part of the $\frac{N}{10}$ sodium carbonate has changed over to sodium sulphate. The extent of this change is dependent, of course, upon the quantity of calcium sulphate, magnesium sul-

phate, etc., present in the water and the measure of the change is indicated by the titration of the filtrate. It is to be noted again that in so far as magnesium sulphate may be present, the magnesium carbonate formed is soluble to a considerable extent, hence the more insoluble magnesium hydroxide is provided for by the use of the "soda reagent," which is part sodium hydroxide.

Some waters will give a titration in the filtrate which is greater in amount than the quantity of soda reagent added. This condition is designated as negative hardness.

EXERCISE X

Negative Hardness.—Throughout the drift region of the Mississippi Valley a very large percentage, especially of the deep wells, yield waters of Class I, as described on page 119. Such waters have no sulphates of calcium or magnesium present. They have, however, some free sodium bicarbonate instead, which indicates that some such reaction as indicated in Exercise IX above has taken place while the water was percolating through the ground. The treatment, therefore, prescribed above would result simply in the addition of more alkali. Hence, the excess of acid required over the 10 cc. of alkali added would be a measure of the free sodium carbonate or "negative hardness" present. Multiplying by (5×5.3) would give the weight in milligrams per liter of Na_2CO_3 . Calculate the negative hardness in terms of calcium carbonate in order to obtain the temporary hardness.

EXERCISE XI

Total Hardness.—The total hardness of a water may be derived (a) from the data which has resulted from Exercises VII and IX above, and (b) from the soap test. It is well to use both sources of information as a check.

(a) Under Exercise VII there will be measured the amount of temporary or bicarbonate hardness; that is, the amount of calcium, magnesium and iron present as bicarbonates, but measured all together in terms of calcium carbonate by the titration with $\frac{N}{10}$ hydrochloric acid or sulphuric acid.

Under Exercise IX there will be indicated the amount of

sulphate or chloride hardness; that is, the amount of calcium, magnesium or iron which may be present in the form of the sulphates or chlorides of these elements, but measured again in the equivalent of calcium carbonate. Be sure that Exercise X has been taken into this account, for, if free sodium bicar-

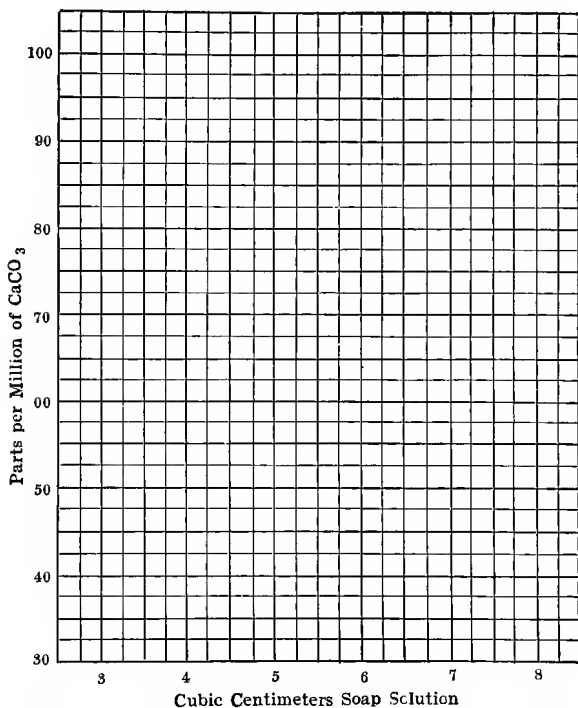

FIG. 49.—Plotting a curve for standard soap solution, showing the value in parts per million of CaCO_3 .

bonate is present, there will be no permanent but only temporary hardness to enter into the total hardness. The sum of the temporary hardness and permanent hardness (if any), given in terms of calcium carbonate, represents the total hardness.

(b) Make a determination of total hardness by means of the standard soap solution as follows:

Measure 50 cc. of the water into a No. 3 beaker, add a few drops of methyl orange and titrate with $\frac{N}{10}$ sulphuric acid to the

end point. Transfer the water thus neutralized to the shaking bottle used for the soap test and run in from a burette, the standard soap solution, a few tenths of a cubic centimeter at a time, shaking vigorously after each addition. The end point is taken in the same manner by noting where, upon laying the bottle on its side after shaking, the lather remains for 5 min. With waters containing magnesium salts care must be taken to avoid mistaking the salts of magnesium end point. After the titration is apparently finished read the burette and add 5 cc. of soap solution. If the end point was due to magnesium the lather disappears. Continue the addition of soap solution until the true end point is reached.

Upon the page of dimension paper herewith, locate a curve which represents the strength of the soap solution used and from this read the amount of parts per million in terms of calcium carbonate. How does the amount compare with the total hardness as derived under (a) above?

EXERCISE XII

Determination of Total Sulphates.—Into a 100-cc. cylinder measure 50 cc. of water and add 25 cc. of sodium chloride solution as on page 207. Make up to exactly 100 cc. in the graduated cylinder. Pour into an Erlenmeyer flask of about 200 cc. capacity and add special barium chloride as in Exercise III for the determination of sulphuric acid. After standing 5 to 20 min., read in the photometer as directed in Chapter XXII, pages 174 to 178.

Refer to the chart on page 176 for the weight of sulphur indicated by the photometer reading. Calculate to sulphuric acid thus

$$32 : 142 :: \text{weight of S} : \text{Na}_2\text{SO}_4$$

EXERCISE XIII

Determination of Total Chlorides.—Measure accurately 50 cc. of water by means of a 50-cc. pipette into a porcelain dish. Add about 1 cc. of potassium chromate solution and titrate with $\frac{N}{100}$ silver nitrate solution, until the yellow color gives place to the first permanent trace of reddish-brown. Do not wait for a red tint to appear. Fill another porcelain dish with 50 cc. of dis-

tilled water and add 1 cc. of the indicator. Use this as a standard of comparison. The first tinge of brownish-red that can be distinguished in the titrated solution is to be taken as the end point.

The reactions involved are

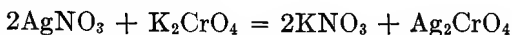

The silver chromate is a red precipitate, but as long as there is any soluble chloride in solution, this breaks up the chromate as follows:

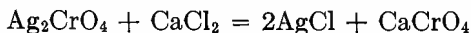

Thus, the first permanent tinge of pink shows that the chlorine of the chloride has all been precipitated. From the volume of silver nitrate used to this point, calculate the weight of chlorine in the 50 cc. taken thus

$$\text{volume } \frac{\text{N}}{100} \text{ AgNO}_3 \times 0.0003545 = \text{weight Cl in 50 cc.}$$

and $0.0005845 \times \text{the volume } \frac{\text{N}}{100} \text{ AgNO}_3 = \text{weight NaCl in 50 cc.}$ of the water. Multiplying further by 20 will give the weight per liter. From this is indicated, by referring to milligrams, the milligrams per liter or parts per million.

EXERCISE XIV

Total Alkalies.—The total alkalies are considered as being made up of all the sulfate not combined as permanent hardness and all of the chlorides. It is true that small amounts of other alkali salts, as sodium nitrate, are present and occasionally some of the chloride is present as magnesium or calcium chloride; but, for the scope of this work and for ordinary technical requirements, it is quite sufficient to consider the total alkalies as being constituted as above indicated.

Procedure.—From the total sulphate as determined under XII and calculated to sodium sulphate, subtract the sulphate hardness as found under IX and which was there calculated also to the equivalent of sodium sulphate for this purpose. The remainder is the amount of alkalies existing in the water in the form of sodium sulphate. To the above should be added the total chloride results under XIII, calculated to sodium chloride.

If free sodium carbonate or negative hardness was developed under X then this also in the form of equivalent sodium carbonate should be added as a third constituent of the alkalies.

The sum of these various constituents, referred in each instance to parts per million, is to be taken as the total alkalies in parts per million. Calculate this sum also to grains per U. S. gallon.

EXERCISE XV

Examination of a Treated Water.—1. If the water has been under treated, it is possible to determine *as with an untreated water* the amounts of lime and soda still needed to soften water.

2. In case excess of soda ash has been added, the permanent hardness will be *negative*; and, if the water has no sodium carbonate present originally, 1.06 times the negative hardness expressed as parts per million of calcium carbonate represents the excess of sodium carbonate which has been added to the water.

3. In most cases, however, a treated water is alkaline to phenolphthalein, in which case 200 cc. is titrated with $\frac{N}{10}$ sulphuric acid, to the end point with phenolphthalein and then on to the end point with methyl orange.

If the amount of acid needed to give the end point with the phenolphthalein is more than half that which is needed to give the end point with methyl orange, an excess of lime is present. If the difference between the two quantities be subtracted from the number of cubic centimeters for the phenolphthalein end point, the result shows the calcium carbonate equivalent in parts per million of the excess of pure lime, CaO. This equivalent multiplied by 56 gives the parts per million of CaO and this result multiplied by $0.0583 \times \frac{1}{4}$ gives the amount in pounds per 1,000 gal.

EXERCISE XVI

Summary of Results and Calculations.—The character of a water is shown by assembling in tabular form the various ingredients grouped in a manner to indicate the total scale-forming and the total foaming ingredients, as called for in the accompanying outline. This summary calls for the various results in grains per gallon, and the order and grouping is that of the Exercises VI to XV.

The calculations for the requisite amount of reagents to remove the scaling ingredients involve simply the calculation from the determined equivalent of calcium carbonate over to the proper reacting substance, thus:

Since one equivalent of excess CO_2 , one equivalent of temporary hardness or one equivalent of magnesium requires one equivalent of calcium oxide for its removal from the water, 0.56 times the sum of the calcium carbonate equivalent of excess carbon dioxide, temporary hardness, and magnesium represents the number of parts per million of pure lime CaO , necessary to remove these impurities.

One and six hundredths times the calcium carbonate equivalent of the permanent hardness is the number of parts per million of sodium carbonate, Na_2CO_3 , necessary to remove the permanent hardness; 0.0583 times the quantities in parts per million $\times \frac{1}{7}$ gives the pounds per thousand gallons needed. The results above are for pure lime and sodium carbonate. Commercial lime and soda ash must be analyzed to determine the amounts of pure lime and sodium carbonate which they contain.

TABLE XXII.—SHOWING THE RATIO OF REAGENT TO INCRUSTING MATERIAL REQUIRED FOR WATER TREATMENT

Weight of 1 U. S. gallon of water at 65°F..... 58,330 grains
1 part · 1,000,000 :: x : 58,330

Hence, x grains per gallon = 0.05833 \times parts per million.

1 part free CO_2	requires 1.27 parts CaO	and leaves no foaming material
1 part Na_2CO_3	requires 0.53 part CaO	and leaves 1 part foaming material
1 part CaCO_3	requires 0.36 part CaO	and leaves no part foaming material
1 part CaSO_4	requires 0.78 part Na_2CO_3	and leaves 1.04 parts foaming material
1 part CaCl_2	requires 0.96 part Na_2CO_3	and leaves 1.05 parts foaming material
1 part MgCO_3	requires 1.33 parts CaO	and leaves no part foaming material
1 part MgSO_4	requires 0.88 part Na_2CO_3 + 0.47 part CaO	and leaves 1.18 parts foaming material
1 part MgCl_2	requires 1.11 parts Na_2CO_3 + 0.59 part CaO	and leaves 1.22 parts foaming material
1 part acid (H_2SO_4)	requires 0.57 parts CaO + 1.08 parts Na_2CO_3	and leaves 1.45 parts foaming material

NOTE.—As an aid to calculations and a correct designation of the kind of alkalinity present the following table will be found helpful:

Letting Pt stand for the titration when using *phenolphthalein* and Mo for the titration when using *methyl-orange*, then—

When $Pt = Mo$ there are present hydroxides only.

When $Pt < Mo > \frac{1}{2} Mo$ there are present hydroxides and normal carbonates.

When $Pt = \frac{1}{2} Mo$ there are present normal carbonates only.

When $Pt < \frac{1}{2} Mo$ there are present normal carbonates and acid carbonate.

When $Pt = 0$ the Mo titration represents acid carbonates only.

SUGGESTED FORM FOR REPORTING RESULTS OBTAINED IN THE
PRECEDING EXERCISES

Analysis of Boiler Water from.....

No..... Sample Taken..... 192..

	Requiring for treatment of 1,000 gal.			
	Grains per gallon	Parts per million	Pounds of slaked lime	Pounds of 99.0 per cent soda ash
Free CO ₂ as CaCO ₃ equivalent.....				
Total alkalinity as CaCO ₃ equivalent				
Temporary hardness as CaCO ₃ equivalent.....				
Negative hardness as CaCO ₃ equivalent.....				
Magnesium as CaCO ₃ equivalent.....				
Permanent hardness as CaCO ₃ equivalent.....				
Total scale forming material.....				
Alkalies as Na ₂ SO ₄				
Alkalies as NaCl.....				
Alkalies as Na ₂ CO ₃				

Remarks.....

.....

.....

By.....

CHAPTER XXVII

OIL EXAMINATION

Specific Gravity.—The specific gravity of oils may be taken with a hydrometer, Westphal balance or pyknometer. The Beaumé hydrometer is the instrument commonly used in connection with industrial oil work. Such readings may be changed to specific gravity by reference to a conversion table (Appendix, Table X) or by application of the formula published by the Bureau of Standards:

$$\text{Sp. gr. } 60^{\circ}/60^{\circ}\text{F.} = \frac{140}{130 + B^{\circ}}$$

The Westphal balance, Fig. 50, for light and medium oils is recommended because it combines in a satisfactory manner both convenience and accuracy. It is provided with a beam graduated by notches into 10 equal parts. With the plummet attached in air, the pointer should stand at zero. The heaviest weight placed on the hook at the end of the beam, that is when located at what would be equivalent to the tenth notch, will exactly counterbalance the plummet when suspended in distilled water at 60°F. The pointer should swing equal distances above and below the zero point or come to

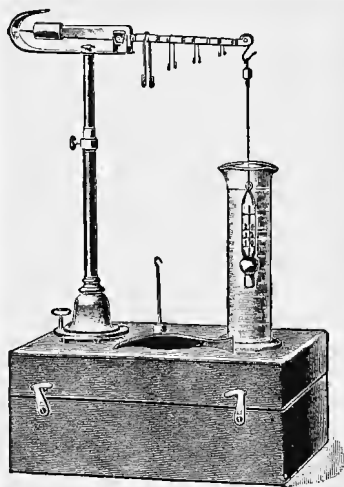

FIG. 50.—Westphal balance.

a rest at zero when adjusting the balance with the plummet in water. The other three weights are respectively equal to $\frac{1}{10}$, $\frac{1}{100}$ and $\frac{1}{1000}$ of the weight of the largest one, hence, their positions on the beam give readings directly in the four decimal places. In testing a liquid the plummet should be immersed so that on the upward swing

it will not come above the liquid. The temperature of the liquid should be carefully taken and if different from 60°F., the specific gravity reading should be corrected to that temperature.

The reading of the weights is taken from their positions on the beam in the order of their size. For example, if the heaviest weight is at 7, the next at 4, the third at 9, and the smallest at 2, the specific gravity reading is 0.7492.



FIG. 51.—Specific gravity bottle, Hubbard type.

If the oil is thick, it should be warmed to allow free movement of the float. The temperature must then be read and corrected for. See table of specific gravities for oils and corrections for temperature, Tables XI and XIV of the Appendix. This would apply also where the hydrometer is the apparatus used.

For oils and tars too heavy for the Westphal balance and for pitches which must be softened for pouring, the pycnometer method is advisable. A special form of instrument of the Hubbard type is recommended.¹ The main features of this pycnometer, Fig. 51, are its straight sides making it easy to clean, and a stopper with a large capillary, 1.6 mm. bore, with a concave space on its lower surface to facilitate the escape of air bubbles. The weight of the clean, dry apparatus *a* is obtained, also the weight *b* of the apparatus full of recently boiled distilled water cooled to 25°C. These values are constants and need to be determined but once. The weight of the pycnometer full of oil *c* at 25°C. will then give the necessary data for the specific gravity, thus:

$$\frac{c - a}{b - a} = \text{specific gravity of the oil}$$

Of course for very heavy material such as pitch where it is desired to only partially fill the receptacle with the sample, the pycnometer method is still applicable. The pitch is melted and a portion poured into the apparatus being careful to avoid

¹ HUBBARD, PREVOST, A useful form of pycnometer for determining the specific gravity of semi-solid bitumens: *Jour. Ind. Eng. Chem.*, vol. 1, p. 475, 1909.

smearing the sides. The weight of the apparatus thus partially filled and brought to room temperature is designated as d . Then by completing the filling with water we have the weight e hence:

$$\frac{(d - a)}{(b - a) - (e - d)} = \text{specific gravity of the sample taken}$$

Flash and Fire Test.—The Cleveland open-cup tester, Fig. 52, is very well suited for determining the flash point of lubricating oils. It has been adopted as the standard by the American Society for Testing Materials. Readings are from 5 to 15° lower than the Pensky-Martens closed tester which is very widely used as a standard.¹

The metal holding about 100 cc. is supported in a tripod ring and heated directly without sand bath or outer cup. It should have a mark $\frac{1}{4}$ in. below the top and another $\frac{3}{8}$ in. below the first, the latter to be used with oils flashing above 425°F.

A thermometer is suspended in the oil midway between the center and the inside edge of the cup. The bulb should be within $\frac{1}{4}$ in. of the bottom and entirely submerged in the oil. The bulb for this purpose should be not over $\frac{3}{8}$ to $\frac{5}{8}$ in. in length.

Heat by a direct flame, rapidly at first, but slower as the flash point is approached, when a test is made for every 5°F. rise in temperature. The flame for testing is supplied from a glass capillary and should be a small bead-like flame not exceeding $\frac{1}{8}$ in. in length. It is passed slowly across the center of the cup $\frac{1}{4}$ in. above the surface of the oil, and occupying 1 sec. in the passage.

The temperature when a flame first jumps from the test flame to the oil is called the flash point. A subdued light and freedom from drafts are essential to satisfactory observations.

¹ The Am. Soc. Testing Mat. (Committee D-21) has made the Tagliabue instrument the standard for obtaining the flash and fire point by the closed tester method.

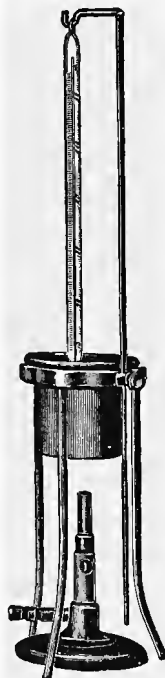

FIG. 52.—Cleveland, open cup, flash and fire point apparatus.

After the flash point has been obtained the fire point is found by continuing the heat till a flame is produced which continues to burn. This temperature is designated as the fire point.

Viscosity.—The specific viscosity of a liquid is the time taken for a given quantity to flow through an orifice as compared

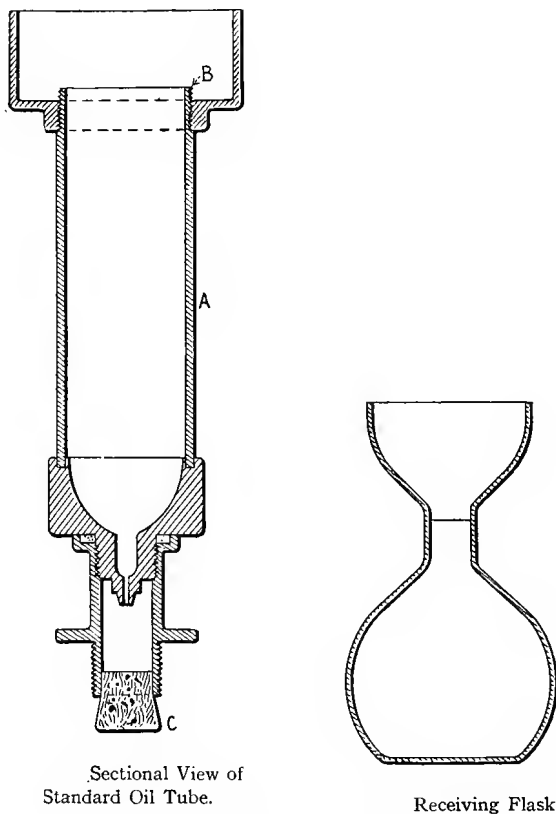

FIG. 53.—Essential features of the Saybolt standard universal viscosimeter.

with water, at a given temperature. A pipette graduated to deliver 100 cc. of water from the bulb alone, that is, not including the lower stem, in 34 sec. is the simplest form of apparatus for such a purpose. In oil work an arbitrary factor is obtained which varies with the type of instrument employed, hence the

viscosity number and the name of the instrument by which it was determined must be coupled together. The Engler viscosimeter is standard with the Teutonic and Scandinavian countries and has been adopted by the International Society for Testing Materials, while in England the Redwood instrument is the standard. The American Society for Testing Materials prescribes (1921 "Standards") that "Viscosity shall be determined by means of the Saybolt Standard Universal Viscosimeter." The most essential parts, omitting the external jacketing bath, are shown in Fig. 53. There is a standard oil tube, *A*, fitted at the top with an overflow cup, *B*. The tube is a small outlet of definite shape and dimension. The lower end of the larger tube is closed by a cork forming an air chamber which prevents the oil from flowing through the standard outlet orifice till the cork is removed. The receiving flask has a capacity at the mark of 60 cc.

Viscosity numbers may be determined at 100, 130 or 210°F. The temperature of the oil in the standard tube is held constant by means of the surrounding bath which is preferably of oil.

To make a test, heat the oil bath to the desired temperature and clean out the oil receptacle, pouring some of the oil to be tested through the tube and allowing it to drain out below. Especial care must be taken that no sediment or lint is allowed to enter the standard tube.

After inserting the stopper at the lower end of the air chamber, fill the standard tube with the oil to be tested. It will save time to have it already heated to near the point desired before adding it to the tester. Oil should be added until it ceases to overflow into the cup at *B*.

Both the bath and the oil sample should be well stirred. When equilibrium at the desired temperature has been established, remove the thermometer or stirrer from the sample and by means of a pipette withdraw the oil from the overflow cup until the level is below the overflow edge at *B*. Place the 60-cc. flask in position, quickly remove the cork and at the same instant start the stop watch. Stir the liquid in the outer bath, maintaining the proper temperature and stop the watch when the bottom of the meniscus reaches the mark.

The time in seconds for the delivery of the 60 cc. is the Saybolt Universal viscosity number of the oil at the designated temperature of the test.

Free Acid.—Lubricating oils should be free from sulphuric acid used in refining and free also from sulphonates resulting from treatment with acid for the removal of unsaturated hydrocarbons. Fatty acids from the oils used in compounding if present in small amount are not so objectionable.

Weigh 10 grams of oil into an Erlenmeyer flask and add 50 cc. of ethyl alcohol which has had 2 or 3 drops of phenolphthalein added and brought to a very faint pink with $\frac{N}{10}$ potassium hydroxide solution. Heat to boiling and agitate well. Titrate the hot solution with $\frac{N}{10}$ KOH solution.

Calculate the number of milligrams of potassium hydroxide required to neutralize the free acids present per gram of oil. This is the acidity number.

Saponification Number.—The fatty oil may be determined by effecting a complete saponification with a known amount of standardized alcoholic potash solution and titrating the unused potash. The solution is made by dissolving 33 grams of stick KOH in 1,000 cc. of purified 95 per cent ethyl alcohol.

Weigh 10 grams of oil into a 350 cc. Erlenmeyer flask and add from a burette 50 cc. of the alcoholic potash solution and 25 cc. of purified or c.p. benzene, C_6H_6 . Boil with a reflux condenser of sufficient length and proper regulation of heat so as to avoid loss of the volatile material. Continue the boiling for 45 min. and add 25 cc. of neutral gasoline. Add 2 or 3 drops of phenolphthalein and titrate with $\frac{N}{2}$ HCl until the pink color is

destroyed. Titrate as a blank an equivalent amount of alcoholic potash solution and purified benzene as used in the saponification process. Calculate the number of milligrams of potassium hydroxide required to saponify 1 gram of the oil. This is the saponification number.¹ For example, each cubic centimeter of

¹ GILL'S "Oil Analysis," 5th ed., p. 65.

$\frac{N}{2}$ HCl is equivalent to 0.02805 gram KOH. Hence,

$$\frac{\text{No. cc. } \frac{N}{2} \text{ acid} \times 0.02805}{\text{Wt. of oil taken}} = \left\{ \begin{array}{l} \text{grams KOK per gram of oil} \\ \text{taken, or saponification No.} \end{array} \right.$$

For the common fatty oils used in compounding, the average saponification number is 195, that is, for every 0.195 gram of KOH there is 1 gram of fatty oil present in the mixture, hence the percentage of such an oil is found by introducing this factor into the above equation and multiplying by 100, thus:

$$\frac{\text{No. cc. } \frac{N}{2} \text{ acid} \times 0.02805}{\text{Wt. of oil taken} \times 0.195} = \left\{ \begin{array}{l} \text{per cent of fatty} \\ \text{oil in the mixture.} \end{array} \right.$$

Maumené Test.—Weigh into a beaker 50 grams of oil. The beaker should be jacketed or so arranged as to avoid loss of heat by radiation. Take the temperature of the oil and retain the thermometer in the oil as a stirrer. Add from a burette with constant stirring drop by drop, 10 cc. of concentrated sulphuric acid and note the highest temperature. Subtract the temperature of the oil at the start. The rise in temperature in degrees Centigrade is the Maumené number. Consult the Table XIV, in the Appendix for possible interpretation of the results. It should be noted that the percentage of saponifiable material in the oil must enter into the conclusion as to the type of fatty oil employed in compounding.

The Conradson Test.¹—Ten cubic centimeters of oil is weighed into a 25 cc. porcelain crucible which is placed inside of a Skidmore iron crucible approximately 55 mm. in diameter by 35 mm. high, with one hole in the cover left open. Place these two inside of a second iron crucible approximately 80 mm. in diameter by 70 mm. high having also a cover. Arrange on a tripod and cover with a hood or inverted assay crucible in such a manner that the heat will be distributed evenly on all sides.

Heat from a Meker burner using a large flame at first which will envelop the large crucible. When vapors from the oil start to ignite above the crucible reduce the flame so that the vapors will come off at a uniform rate burning at a height of

¹ Am. Soc. for Testing Mat., "Standards," p. 701, 1921.

about 5 cm. above the large crucible. After the vapors cease, increase the heat as at first and continue for 5 min. The bottom of the large crucible should be red hot. Allow the temperature to reduce before opening, remove the porcelain crucible to a desiccator, cool and weigh. Approximately $\frac{1}{2}$ hr. will be required for the process when properly regulated. The deposit as percentage of the original sample is designated as carbon residue, from the Conradson test.

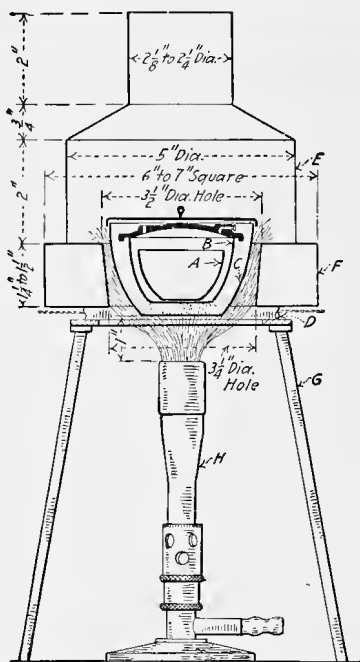

FIG. 54.—Conradson carbon-residue apparatus.

Emulsification.—The emulsification test as adopted by the Am. Soc. Testing Mat.,¹ may be summarized as follows:

Twenty cubic centimeters of oil and 40 cc. of distilled water are placed in a 100-cc. graduated cylinder of approximately 1 in. inside diameter, and heated in a water bath at 130°F. A mechanical stirrer is then introduced for 5 min. It should have an r.p.m. of 1,500 and the paddle should be entirely submerged.

¹ Am. Soc. for Testing Mat., *Technical Papers*, Part II, p. 248, 1916.

The suggested size of the paddle is $3\frac{1}{2}$ by $\frac{11}{16}$ by $\frac{1}{8}$ in. attached with its longest dimension in line with the driving shaft. After stirring, the mixture is allowed to stand in the bath at 130°F . At convenient intervals, readings are taken of the volume of clear oil which settles out noting the point of separation in line with the upper surface of the meniscus.

Calculate the rate of demulsification in cubic centimeters per hour. Note that the average rate is taken. That is if D is the total volume demulsified at any stage and t the time in minutes from the cessation of stirring, then

$$\frac{D \times 60}{t} = \text{rate of demulsification per hour.}$$

It is to be observed that the cylinder readings are from the bottom up, and that D in the above expression is 60 minus the upper surface reading of the emulsion. Hence if the reading at the end of 1 min. is 40, then the demulsified portion $\times 60 = 1,200$, or the rate of demulsification per hour. This would be the highest possible demulsibility. If the readings showed 10 cc. demulsified at the end of 15 min., the rate would be $\frac{10}{15} \times 60 = 40$ cc. per hour. A complete table for time and readings from 59 to 40 is a convenience.¹

¹ See Table III, Am. Soc. for Testing Mat., Part II, p. 258, 1920.

APPENDIX

TABLE I.—INTERNATIONAL ATOMIC WEIGHTS (1921)

	Symbol	Atomic weight		Symbol	Atomic weight
Aluminum.....	Al	27.1	Molybdenum.....	Mo	96.0
Antimony.....	Sb	120.2	Neodymium.....	Nd	144.3
Argon.....	A	39.9	Neon.....	Ne	20.2
Arsenic.....	As	74.96	Nickel.....	Ni	58.68
Barium.....	Ba	137.37	Niton (radium emanation).....	Nt	222.4
Bismuth.....	Bi	208.0	Nitrogen.....	N	14.008
Boron.....	B	10.9	Osmium.....	Os	190.9
Bromine.....	Br	79.92	Oxygen.....	O	16.0
Cadmium.....	Cd	112.40	Palladium.....	Pd	106.7
Caesium.....	Cs	132.81	Phosphorus.....	P	31.04
Calcium.....	Ca	40.07	Platinum.....	Pt	195.2
Carbon.....	C	12.005	Potassium.....	K	39.1
Cerium.....	Ce	140.25	Praseodymium.....	Pr	140.9
Chlorine.....	Cl	35.46	Radium.....	Ra	226.0
Chromium.....	Cr	52.0	Rhodium.....	Rh	102.9
Cobalt.....	Co	58.97	Rubidium.....	Rb	85.45
Columbium.....	Cb	93.1	Ruthenium.....	Ru	101.7
Copper.....	Cu	63.57	Samarium.....	Sa	150.4
Dysprosium.....	Dy	162.5	Scandium.....	Sc	45.1
Erbium.....	Er	167.7	Selenium.....	Se	79.2
Europium.....	Eu	152.0	Silicon.....	Si	28.3
Fluorine.....	F	19.0	Silver.....	Ag	107.88
Gadolinium.....	Gd	157.3	Sodium.....	Na	23.0
Gallium.....	Ga	70.1	Strontium.....	Sr	87.63
Germanium.....	Ge	72.5	Sulphur.....	S	32.06
Glucinum.....	Gl	9.1	Tantalum.....	Ta	181.5
Gold.....	Au	197.2	Tellurium.....	Te	127.5
Helium.....	He	4.0	Terbium.....	Tb	159.2
Holmium.....	Ho	163.5	Thallium.....	Tl	204.0
Hydrogen.....	H	1.008	Thorium.....	Th	232.15
Indium.....	In	114.8	Thulium.....	Tm	168.5
Iodine.....	I	126.92	Tin.....	Sn	118.7
Iridium.....	Ir	193.1	Titanium.....	Ti	48.1
Iron.....	Fe	55.84	Tungsten.....	W	184.0
Krypton.....	Kr	82.92	Uranium.....	U	238.2
Lanthanum.....	La	139.0	Vanadium.....	V	51.0
Lead.....	Pb	207.2	Xenon.....	Xe	130.2
Lithium.....	Li	6.94	Ytterbium (Neoytterbium).....	Yb	173.5
Lutecium.....	Lu	175.0	Yttrium.....	Yt	89.33
Magnesium.....	Mg	24.32	Zinc.....	Zn	65.37
Manganese.....	Mn	54.93	Zirconium.....	Zr	90.6
Mercury.....	Hg	200.6			

TABLE II.—MISCELLANEOUS CONVERSION FACTORS

Lengths

1 in. = 2.54 cm.	1 mm. = 0.03937 in.
1 ft. = 0.3048 m.	1 cm. = 0.3937 in.
1 yd. = 0.9144 m.	1 m. = 3.28 ft.
1 mi. = 1.60935 km.	1 km. = 0.62137 mi.

Volumes

1 cu. in. = 16.3872 cu. cm.	1 cu. cm. = 0.061 cu. in.
1 cu. ft. = 0.02832 cu. m.	1 liter = 61.025 cu. in.
1 cu. yd. = 0.7645 cu. m.	1 cu. m. = 1.3079 cu. yd.

Capacities

1 qt. = 0.94633 liters	1 liter = 1.05671 qt.
1 gal. = 3.78533 liters	1 liter = 0.26418 gal.

Masses

1 oz. av. = 28.3495 grams	1 gram = 0.03527 oz.
1 lb. av. = 453.59 grams	1 kilo = 2.20462 lb.
1 gram = 15.43235 grains	
1 oz. = 437.5 grains	
1 lb. = 7,000.0 grains	
1 U. S. gallon = 58,333.0 grains	
1 Imp. gallon = 70,000.0 grains	

Heat Values

1 B.t.u. = 251.99 cal.
1 cal. = 0.003968 B.t.u.
1 B.t.u. per pound = 0.5556 Cal. per gram
1 cal. per gram = 1.8 B.t.u.'s per pound
1 B.t.u. = 0.252 Cal.
1 Cal. = 3.968 B.t.u.
1 B.t.u. per pound = 0.5556 Cal. per kilo
1 Cal. per kilo = 1.8 B.t.u.'s per pound

TABLE III.—CONVERSION TABLES FOR TEMPERATURES
Centigrade to Fahrenheit

Temperature, degrees Centigrade	0	1	2	3	4	5	6	7	8	9
0	32.0	33.8	35.6	37.4	39.2	41.0	42.8	44.6	46.4	48.2
10	50.0	51.8	53.6	55.4	57.2	59.0	60.8	62.6	64.4	66.2
20	68.0	69.8	71.6	73.4	75.2	77.0	78.8	80.6	82.4	84.2
30	86.0	87.8	89.6	91.4	93.2	95.0	96.8	98.6	100.4	102.2
40	104.0	105.8	107.6	109.4	111.2	113.0	114.8	116.6	118.4	120.2
50	122.0	123.8	125.6	127.4	129.2	131.0	132.8	134.6	136.6	138.2
60	140.0	141.8	143.6	145.4	147.2	149.0	150.8	152.6	154.4	156.2
70	158.0	159.8	161.6	163.4	165.2	176.0	168.8	170.6	172.4	174.2
80	176.0	177.8	179.6	181.4	183.2	185.0	186.8	188.6	190.4	192.2
90	194.0	195.8	197.6	199.4	201.2	203.0	204.8	206.6	208.4	210.2
100	212.0	213.8	215.6	217.4	219.2	221.0	222.8	224.6	226.4	228.2

TABLE IV.—FACTORS FOR REDUCTION OF GAS VOLUME TO 60° F. AND 30 IN. OF MERCURY PRESSURE AND SATURATION WITH MOISTURE

	Barometer																				
	28.5	28.7	28.8	28.9	29.0	29.1	29.2	29.3	29.4	29.5	29.6	29.7	29.8	29.9	30.0	30.1	30.2	30.3	30.4	30.5	
107	0.816	0.820	0.823	0.826	0.829	0.832	0.835	0.838	0.841	0.844	0.847	0.851	0.854	0.857	0.860	0.863	0.866	0.867	0.870	0.874	0.877
106	0.820	0.823	0.826	0.829	0.832	0.835	0.838	0.841	0.844	0.847	0.851	0.854	0.857	0.860	0.863	0.866	0.867	0.870	0.874	0.878	0.881
105	0.823	0.827	0.830	0.833	0.836	0.839	0.842	0.845	0.848	0.851	0.855	0.858	0.861	0.864	0.867	0.870	0.871	0.874	0.878	0.881	0.884
104	0.827	0.830	0.833	0.836	0.839	0.842	0.845	0.848	0.851	0.854	0.858	0.861	0.864	0.867	0.870	0.871	0.874	0.878	0.881	0.885	0.887
103	0.830	0.834	0.837	0.840	0.843	0.847	0.849	0.852	0.855	0.858	0.862	0.865	0.868	0.871	0.874	0.875	0.878	0.881	0.885	0.888	0.891
102	0.834	0.837	0.840	0.843	0.847	0.850	0.853	0.856	0.859	0.862	0.865	0.868	0.871	0.874	0.878	0.881	0.885	0.888	0.891	0.895	0.898
101	0.837	0.840	0.843	0.846	0.850	0.853	0.856	0.859	0.862	0.865	0.868	0.872	0.875	0.878	0.881	0.885	0.888	0.891	0.895	0.898	0.898
100	0.840	0.843	0.846	0.849	0.853	0.856	0.859	0.862	0.865	0.868	0.872	0.875	0.878	0.881	0.885	0.888	0.891	0.895	0.898	0.901	0.905
99	0.844	0.847	0.850	0.853	0.857	0.860	0.863	0.866	0.869	0.872	0.876	0.879	0.882	0.885	0.889	0.892	0.895	0.898	0.902	0.905	0.908
98	0.847	0.850	0.853	0.856	0.860	0.863	0.866	0.869	0.872	0.875	0.879	0.882	0.885	0.888	0.892	0.895	0.898	0.902	0.905	0.908	0.911
97	0.850	0.853	0.856	0.859	0.863	0.866	0.870	0.873	0.876	0.879	0.882	0.885	0.888	0.891	0.894	0.898	0.901	0.905	0.908	0.911	0.914
96	0.854	0.857	0.860	0.863	0.867	0.870	0.873	0.876	0.879	0.882	0.886	0.889	0.892	0.895	0.898	0.901	0.904	0.908	0.911	0.914	0.914
95	0.857	0.860	0.863	0.866	0.870	0.873	0.876	0.879	0.882	0.885	0.889	0.892	0.895	0.898	0.901	0.904	0.908	0.911	0.914	0.918	0.918
94	0.860	0.863	0.866	0.869	0.873	0.876	0.879	0.882	0.885	0.888	0.892	0.895	0.898	0.901	0.904	0.907	0.911	0.914	0.918	0.921	0.924
93	0.863	0.866	0.869	0.872	0.876	0.879	0.883	0.886	0.889	0.891	0.895	0.898	0.901	0.904	0.907	0.910	0.914	0.918	0.921	0.924	0.924
92	0.866	0.869	0.872	0.875	0.879	0.882	0.885	0.889	0.892	0.894	0.898	0.902	0.904	0.907	0.910	0.914	0.917	0.921	0.924	0.928	0.928
91	0.869	0.872	0.875	0.879	0.882	0.885	0.889	0.892	0.895	0.898	0.902	0.905	0.908	0.911	0.914	0.917	0.921	0.924	0.928	0.931	0.931
90	0.872	0.875	0.878	0.881	0.885	0.888	0.892	0.895	0.898	0.901	0.905	0.908	0.911	0.914	0.917	0.920	0.924	0.927	0.931	0.934	0.934
89	0.875	0.878	0.882	0.885	0.889	0.892	0.895	0.898	0.901	0.904	0.907	0.910	0.914	0.917	0.920	0.923	0.927	0.931	0.934	0.937	0.940
88	0.878	0.881	0.885	0.888	0.892	0.895	0.898	0.901	0.904	0.907	0.910	0.913	0.917	0.920	0.923	0.926	0.930	0.934	0.937	0.940	0.943
87	0.881	0.884	0.888	0.891	0.895	0.898	0.901	0.904	0.907	0.910	0.913	0.916	0.920	0.923	0.926	0.929	0.933	0.937	0.940	0.943	0.946
86	0.884	0.887	0.890	0.894	0.898	0.901	0.904	0.907	0.910	0.913	0.916	0.919	0.923	0.926	0.929	0.932	0.936	0.940	0.943	0.946	0.949
85	0.887	0.890	0.893	0.896	0.900	0.903	0.906	0.909	0.913	0.916	0.919	0.922	0.926	0.929	0.932	0.936	0.939	0.943	0.946	0.949	0.952
84	0.889	0.893	0.896	0.899	0.903	0.906	0.909	0.912	0.915	0.919	0.922	0.925	0.928	0.932	0.935	0.939	0.942	0.946	0.949	0.952	0.955
83	0.892	0.895	0.899	0.902	0.906	0.909	0.912	0.915	0.918	0.921	0.924	0.928	0.931	0.935	0.938	0.942	0.945	0.949	0.952	0.955	0.958
82	0.895	0.898	0.901	0.905	0.908	0.911	0.914	0.918	0.921	0.924	0.927	0.931	0.934	0.937	0.941	0.945	0.948	0.951	0.954	0.958	0.960
81	0.898	0.901	0.905	0.908	0.911	0.914	0.917	0.921	0.924	0.927	0.930	0.934	0.937	0.940	0.944	0.948	0.951	0.954	0.957	0.960	0.960

Temperature degrees Fahrenheit

TABLE IV.—FACTORS FOR REDUCTION OF GAS VOLUME TO 60°F. AND 30 IN. OF MERCURY PRESSURE AND SATURATION WITH MOISTURE—(Continued)

	Barometer																				
	28.5	28.7	28.8	28.9	29.0	29.1	29.2	29.3	29.4	29.5	29.6	29.7	29.8	29.9	30.0	30.1	30.2	30.3	30.4	30.5	
80	0.901	0.904	0.907	0.910	0.914	0.917	0.920	0.923	0.927	0.930	0.933	0.937	0.940	0.943	0.946	0.950	0.954	0.957	0.960	0.963	0.967
79	0.904	0.907	0.910	0.914	0.917	0.920	0.923	0.926	0.930	0.933	0.936	0.939	0.943	0.946	0.949	0.953	0.956	0.960	0.963	0.967	0.971
78	0.906	0.909	0.913	0.916	0.919	0.923	0.926	0.929	0.932	0.936	0.939	0.942	0.946	0.949	0.952	0.956	0.959	0.962	0.966	0.969	0.974
77	0.909	0.912	0.915	0.919	0.922	0.925	0.928	0.931	0.935	0.938	0.941	0.944	0.948	0.951	0.955	0.958	0.961	0.965	0.968	0.972	0.976
76	0.914	0.917	0.921	0.924	0.928	0.931	0.934	0.937	0.940	0.943	0.947	0.950	0.954	0.957	0.960	0.963	0.967	0.971	0.974	0.978	0.982
74	0.917	0.920	0.924	0.927	0.930	0.933	0.937	0.940	0.943	0.947	0.950	0.953	0.957	0.960	0.963	0.966	0.970	0.973	0.977	0.980	0.984
73	0.920	0.923	0.926	0.930	0.933	0.936	0.940	0.943	0.946	0.949	0.953	0.956	0.960	0.963	0.966	0.969	0.972	0.976	0.980	0.983	0.986
72	0.922	0.925	0.929	0.932	0.935	0.939	0.942	0.945	0.949	0.952	0.955	0.959	0.962	0.965	0.968	0.972	0.975	0.979	0.982	0.986	0.989
71	0.925	0.928	0.931	0.935	0.938	0.941	0.945	0.948	0.951	0.954	0.958	0.961	0.965	0.968	0.971	0.975	0.978	0.981	0.985	0.989	0.991
70	0.927	0.931	0.934	0.937	0.941	0.944	0.947	0.950	0.953	0.957	0.960	0.963	0.967	0.970	0.973	0.977	0.980	0.983	0.987	0.990	0.994
68	0.932	0.936	0.939	0.942	0.946	0.949	0.952	0.956	0.959	0.962	0.965	0.969	0.972	0.975	0.979	0.982	0.985	0.989	0.992	0.996	1.000
67	0.935	0.938	0.942	0.945	0.949	0.952	0.955	0.959	0.962	0.965	0.968	0.972	0.975	0.979	0.982	0.985	0.989	0.992	0.996	1.000	1.004
66	0.938	0.941	0.944	0.948	0.951	0.954	0.958	0.961	0.964	0.968	0.971	0.974	0.978	0.981	0.985	0.988	0.992	0.995	0.998	1.002	1.006
65	0.941	0.944	0.947	0.950	0.954	0.957	0.960	0.963	0.967	0.970	0.973	0.977	0.980	0.984	0.987	0.991	0.994	0.997	1.001	1.005	1.009
64	0.943	0.946	0.949	0.953	0.956	0.959	0.963	0.966	0.969	0.973	0.976	0.980	0.983	0.986	0.990	0.994	0.997	1.000	1.004	1.008	1.012
63	0.945	0.949	0.952	0.955	0.959	0.962	0.965	0.969	0.972	0.975	0.979	0.982	0.985	0.989	0.993	0.996	1.000	1.003	1.006	1.010	1.014
62	0.947	0.951	0.954	0.958	0.961	0.964	0.968	0.971	0.975	0.978	0.981	0.985	0.988	0.991	0.995	0.999	1.002	1.005	1.009	1.013	1.017
61	0.950	0.954	0.957	0.961	0.964	0.967	0.971	0.974	0.977	0.981	0.984	0.987	0.991	0.994	0.998	1.001	1.005	1.008	1.011	1.015	1.019
60	0.952	0.956	0.959	0.963	0.966	0.969	0.973	0.976	0.980	0.983	0.986	0.990	0.993	0.997	1.000	1.004	1.007	1.010	1.014	1.017	1.021
59	0.955	0.959	0.962	0.966	0.969	0.972	0.976	0.979	0.983	0.986	0.989	0.992	0.995	0.999	1.003	1.006	1.010	1.013	1.016	1.020	1.024
68	0.957	0.961	0.964	0.968	0.971	0.975	0.978	0.981	0.985	0.988	0.992	0.995	0.998	1.002	1.005	1.009	1.012	1.016	1.019	1.023	1.027
67	0.960	0.963	0.967	0.970	0.974	0.977	0.980	0.984	0.988	0.991	0.994	0.997	1.000	1.004	1.007	1.011	1.014	1.018	1.021	1.025	1.029
56	0.962	0.966	0.969	0.973	0.976	0.979	0.982	0.986	0.990	0.993	0.996	1.000	1.003	1.007	1.010	1.014	1.017	1.021	1.024	1.028	1.032
56	0.965	0.968	0.972	0.975	0.979	0.982	0.985	0.989	0.993	0.996	0.999	1.002	1.006	1.009	1.013	1.016	1.020	1.023	1.027	1.030	1.034
54	0.967	0.970	0.974	0.977	0.981	0.984	0.988	0.991	0.995	0.998	1.001	1.005	1.008	1.012	1.015	1.019	1.022	1.026	1.029	1.033	1.037

Temperature degrees Fahrenheit

TABLE IV.—FACTORS FOR REDUCTION OF GAS VOLUME TO 60°F. AND 30 IN. OF MERCURY PRESSURE AND SATURATION WITH MOISTURE—(Continued)

		Barometer																				
		28.5	28.7	28.8	28.9	29.0	29.1	29.2	29.3	29.4	29.5	29.5	29.6	29.7	29.8	29.9	30.0	30.1	30.2	30.3	30.4	30.5
53	0.969	0.973	0.976	0.980	0.983	0.986	0.989	0.992	0.993	0.997	1.000	1.004	1.007	1.011	1.014	1.018	1.021	1.025	1.028	1.031	1.034	1.038
52	0.971	0.975	0.978	0.982	0.985	0.989	0.992	0.996	0.998	0.999	1.003	1.006	1.010	1.013	1.017	1.021	1.025	1.029	1.033	1.037	1.041	1.045
51	0.974	0.977	0.981	0.984	0.988	0.991	0.995	0.998	0.998	1.002	1.005	1.009	1.012	1.016	1.020	1.024	1.028	1.032	1.036	1.040	1.044	1.048
50	0.976	0.980	0.983	0.987	0.990	0.994	0.997	1.001	1.004	1.008	1.011	1.015	1.019	1.022	1.026	1.029	1.033	1.036	1.040	1.043	1.047	1.050
49	0.979	0.982	0.986	0.989	0.993	0.996	1.000	1.003	1.007	1.011	1.015	1.019	1.022	1.026	1.029	1.033	1.036	1.040	1.043	1.047	1.050	1.053
48	0.981	0.985	0.988	0.992	0.995	0.999	1.002	1.006	1.010	1.013	1.017	1.020	1.024	1.027	1.031	1.034	1.038	1.041	1.045	1.048	1.052	1.056
47	0.984	0.987	0.991	0.994	0.998	1.001	1.005	1.008	1.012	1.015	1.019	1.022	1.026	1.029	1.033	1.036	1.040	1.043	1.047	1.050	1.054	1.058
46	0.986	0.990	0.993	0.997	1.000	1.004	1.007	1.011	1.014	1.018	1.021	1.025	1.029	1.032	1.036	1.039	1.043	1.046	1.050	1.053	1.057	1.060
45	0.989	0.992	0.996	0.999	1.003	1.006	1.010	1.013	1.017	1.020	1.024	1.027	1.031	1.034	1.038	1.041	1.045	1.048	1.052	1.055	1.059	1.063
44	0.991	0.994	0.998	1.001	1.005	1.008	1.012	1.015	1.019	1.022	1.026	1.030	1.034	1.037	1.041	1.044	1.048	1.051	1.055	1.058	1.062	1.065
43	0.993	0.997	1.001	1.004	1.008	1.011	1.015	1.018	1.022	1.025	1.029	1.032	1.036	1.039	1.043	1.046	1.050	1.053	1.057	1.060	1.064	1.068
42	0.995	0.999	1.003	1.006	1.010	1.013	1.017	1.020	1.024	1.028	1.031	1.035	1.038	1.042	1.045	1.049	1.052	1.056	1.059	1.063	1.066	1.070
41	0.998	1.001	1.005	1.009	1.012	1.016	1.019	1.023	1.026	1.029	1.032	1.036	1.039	1.043	1.046	1.050	1.053	1.057	1.060	1.064	1.068	1.072
40	1.000	1.004	1.007	1.011	1.014	1.018	1.021	1.025	1.028	1.032	1.035	1.038	1.042	1.045	1.049	1.052	1.056	1.059	1.063	1.066	1.070	1.074
39	1.002	1.006	1.010	1.013	1.017	1.020	1.024	1.027	1.031	1.035	1.038	1.042	1.045	1.049	1.052	1.056	1.059	1.063	1.066	1.070	1.074	1.078
38	1.005	1.009	1.012	1.016	1.020	1.023	1.027	1.030	1.034	1.037	1.041	1.044	1.048	1.051	1.055	1.058	1.062	1.065	1.069	1.073	1.077	1.081
37	1.007	1.011	1.015	1.018	1.022	1.025	1.029	1.032	1.036	1.039	1.043	1.046	1.050	1.053	1.057	1.060	1.064	1.068	1.072	1.076	1.080	1.084
36	1.009	1.013	1.017	1.020	1.024	1.027	1.031	1.035	1.038	1.042	1.045	1.049	1.052	1.056	1.059	1.063	1.066	1.070	1.074	1.078	1.082	1.086
35	1.012	1.015	1.019	1.022	1.026	1.030	1.033	1.037	1.041	1.044	1.048	1.051	1.055	1.058	1.062	1.065	1.069	1.073	1.077	1.081	1.085	1.089
34	1.014	1.018	1.022	1.025	1.029	1.033	1.036	1.040	1.043	1.047	1.050	1.054	1.057	1.061	1.064	1.068	1.072	1.075	1.079	1.083	1.087	1.091
33	1.016	1.020	1.024	1.027	1.031	1.034	1.038	1.042	1.046	1.049	1.053	1.056	1.060	1.063	1.067	1.070	1.074	1.078	1.082	1.086	1.090	1.094
32	1.019	1.023	1.027	1.030	1.034	1.037	1.041	1.044	1.048	1.051	1.055	1.058	1.062	1.065	1.069	1.073	1.077	1.081	1.085	1.089	1.093	1.097
31	1.021	1.025	1.029	1.032	1.036	1.039	1.043	1.047	1.050	1.054	1.057	1.061	1.064	1.068	1.072	1.075	1.079	1.083	1.087	1.091	1.095	1.099
30	1.023	1.027	1.031	1.034	1.038	1.042	1.045	1.049	1.053	1.056	1.060	1.063	1.067	1.071	1.074	1.078	1.082	1.086	1.090	1.094	1.098	1.102

Temperature degrees Fahrenheit

TABLE V.—RELATIVE HUMIDITY

As determined from readings of wet and dry bulb thermometer. Calculated for barometric pressure of 29.0 in. of mercury

All temperatures in Fahrenheit degrees

Air temperature	Depression of wet bulb thermometer ($t - t'$)																								
	1	2	3	4	5	6	7	8	9	10	11	12	13	14	15	16	17	18	19	20	21	22	23	24	25
30	89	78	68	57	47	37	27	17	8																
35	91	82	73	64	55	46	37	29	20	12	4														
40	92	84	76	68	61	53	46	38	31	23	16	9	2												
45	93	86	79	71	65	58	52	45	39	33	26	20	14	8	2										
50	93	87	81	74	68	62	56	50	44	39	33	28	22	17	12	7	2								
55	94	88	82	76	71	65	60	55	49	44	39	34	29	25	20	15	11	6	2						
60	94	89	84	78	73	68	63	58	53	49	44	40	35	31	27	22	18	14	10	6	2				
65	95	90	85	80	75	70	66	62	57	53	48	44	40	36	32	28	25	21	17	13	10	7	3		
70	95	90	86	81	77	72	68	64	60	56	52	48	44	40	37	33	30	26	23	20	17	13	10	7	4
75	96	91	87	82	78	74	70	66	63	59	55	51	48	44	41	38	34	31	28	25	22	19	16	13	11
80	96	91	87	83	79	76	72	68	64	61	57	54	51	47	44	41	38	35	32	29	27	24	21	18	16
85	96	92	88	84	80	77	74	70	66	63	60	57	54	50	47	44	41	39	36	33	31	28	25	23	20
90	96	92	89	85	81	78	75	71	68	65	62	59	56	53	50	47	44	42	39	37	34	32	29	27	24
95	96	93	89	86	82	79	76	73	70	66	64	61	58	55	52	50	47	45	42	40	37	35	32	30	28
100	96	93	90	86	83	80	77	74	71	68	65	62	59	57	54	52	49	47	44	42	40	37	35	33	31

TABLE VI.—CORRECTIONS, IN BRITISH THERMAL UNITS, TO BE APPLIED TO OBSERVED HEATING VALUES IN CALCULATING TOTAL HEATING VALUES OF ILLUMINATING GAS (About 600 B.t.u.)¹

The tabular corrections are applicable when inlet water, air, gas, and products are all at approximately the same temperature, and when the calorimeter is operated at *normal rate* of gas consumption.

Temperature of room, etc. degrees Fahrenheit	Relative humidity of air									
	10 per cent	20 per cent	30 per cent	40 per cent	50 per cent	60 per cent	70 per cent	80 per cent	90 per cent	100 per cent
40	+ 2	+ 2	+ 1	+1	+1	+1	0	0	0	-1
45	+ 2	+ 2	+ 2	+1	+1	+1	0	0	0	-1
50	+ 3	+ 3	+ 2	+2	+1	+1	0	0	0	-1
55	+ 3	+ 3	+ 3	+2	+1	+1	+1	0	0	-1
60	+ 4	+ 4	+ 3	+2	+2	+1	+1	0	0	-1
65	+ 5	+ 4	+ 4	+3	+2	+2	+1	0	-1	-1
70	+ 6	+ 5	+ 4	+3	+3	+2	+1	0	-1	-2
75	+ 7	+ 6	+ 5	+4	+3	+2	+1	0	-1	-2
80	+ 8	+ 7	+ 6	+5	+4	+3	+1	0	-1	-2
85	+10	+ 9	+ 7	+6	+4	+3	+2	0	-1	-3
90	+12	+10	+ 9	+7	+5	+4	+2	0	-2	-3
95	+14	+12	+10	+8	+6	+4	+2	0	-2	-4

¹ U. S. Bureau of Standards. *Technologic Paper 36.*

TABLE VII.—EMERGENT STEM CORRECTIONS TO READING OF OUTLET-WATER THERMOMETERS FOR DIFFERENT IMMERSIONS OF THERMOMETERS IN CALORIMETER FOR DETERMINING HEATING VALUE OF GAS

Table applicable when temperature of inlet water is approximately equal to room temperature.

	Temperature rise of water, degrees Fahrenheit	Temperature of room					
		50°	60°	70°	80°	90°	100°
Thermometer immersed to 30°F...	10	+0.02	+0.03	+0.04	+0.05	+0.05	+0.06
	15	+0.04	+0.05	+0.06	+0.07	+0.09	+0.10
	20	+0.06	+0.07	+0.09	+0.11	+0.13	+0.15
Thermometer immersed to 40°F...	10	+0.01	+0.02	+0.03	+0.03	+0.04	+0.05
	15	+0.03	+0.04	+0.05	+0.06	+0.08	+0.09
	20	+0.04	+0.05	+0.07	+0.09	+0.11	+0.12
Thermometer immersed to 50°F...	10	+0.01	+0.01	+0.02	+0.03	+0.04	+0.05
	15	+0.02	+0.03	+0.04	+0.05	+0.07	+0.08
	20	+0.02	+0.04	+0.06	+0.07	+0.09	+0.11
Thermometer immersed to 60°F...	10	+0.00	+0.01	+0.02	+0.02	+0.03	+0.04
	15	+0.00	+0.01	+0.03	+0.04	+0.05	+0.06
	20	+0.00	+0.02	+0.04	+0.05	+0.07	+0.09

This table is not applicable if the emergent portion of the stem includes an enlargement in the capillary.

Instead of using the above table, it will probably be somewhat more convenient to make out a stem-correction table for the particular outlet-water thermometer that is to be used with the calorimeter, the data for this separate stem-correction table being interpolated from the above table.

Suppose, for example, the outlet-water thermometer to be used was one that was immersed to the 30°F. mark on the scale, and a stem-correction table were wanted for an 18°F. rise in temperature, then from the above table we obtain the following stem-correction table:

STEM CORRECTION FOR OUTLET-WATER THERMOMETER NO.—

Table applicable when inlet water is approximately at room temperature, when thermometer is immersed to the 30°F. mark, and when the temperature rise is approximately 18°F.

Inlet-water temperature, degrees Fahrenheit	Stem correction, degree	Inlet-water temperature, degrees Fahrenheit	Stem correction, degree
50	0.05	80	0.09
60	0.06	90	0.11
70	0.08	100	0.13

¹From U. S. Bureau of Standards, *Circular 48*.

TABLE VIII.—SOLUBILITIES APPLICABLE TO BOILER WATERS

(a) Solubility of gypsum

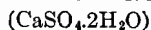

1 part dissolves in about 500 parts of water at 60°F.

1 part dissolves in about 1,200 parts of water at 250°F.

1 part dissolves in about 1,800 parts of water at 300°F.

1 part dissolves in about 3,800 parts of water at 325°F.

(b) Solubility of lime and hydrated lime

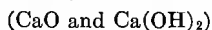

Amount required to saturate one U. S. gallon

78 grains CaO or 103.0 grains Ca(OH)_2 at 60°F.70 grains CaO or 92.5 grains Ca(OH)_2 at 86°F.58 grains CaO or 76.6 grains Ca(OH)_2 at 112°F.51 grains CaO or 67.4 grains Ca(OH)_2 at 140°F.33 grains CaO or 43.6 grains Ca(OH)_2 at 212°F.TABLE IX.¹—EQUIVALENT OF DEGREES BAUMÉ (AMERICAN STANDARD)
AND SPECIFIC GRAVITY AT 60°F. (HEAVIER THAN WATER)

Degrees Baumé	0	1	2	3	4	5	6	7	8	9
0	1.0000	1.0069	1.0140	1.0211	1.0284	1.0357	1.0432	1.0507	1.0584	1.0662
10	1.0741	1.0821	1.0902	1.0985	1.1069	1.1154	1.1240	1.1328	1.1417	1.1508
20	1.1600	1.1694	1.1789	1.1885	1.1983	1.2083	1.2185	1.2288	1.2393	1.2500
30	1.2609	1.2719	1.2832	1.2946	1.3063	1.3182	1.3303	1.3426	1.3551	1.3679
40	1.3810	1.3924	1.4078	1.4216	1.4356	1.4500	1.4646	1.4796	1.4948	1.5104
50	1.5263	1.5426	1.5591	1.5761	1.5934	1.6111	1.6292	1.6477	1.6667	1.6860
60	1.7059	1.7262	1.7470	1.7683	1.7901	1.8125	1.8354	1.8590	1.8831	1.9079

¹ For more complete table see VAN NOSTRAND'S "Chemical Annual."

TABLE X.¹—CONVERSION TABLE FOR DEGREES BAUMÉ (LIGHTER THAN WATER) TO SPECIFIC GRAVITY AND POUNDS PER GALLON

Degrees Baumé	Specific gravity	Pounds in 1 gal. (American)	Degrees Baumé	Specific gravity	Pounds in 1 gal. (American)
10	1.0000	8.33	43	0.8092	6.74
11	0.9929	8.27	44	0.8045	6.70
12	0.9859	8.21	45	0.8000	6.66
13	0.9790	8.16	46	0.7954	6.63
14	0.9722	8.10	47	0.7909	6.59
15	0.9655	8.04	48	0.7865	6.55
16	0.9589	7.99	49	0.7800	6.52
17	0.9523	7.93	50	0.7777	6.48
18	0.9459	7.88	51	0.7734	6.44
19	0.9395	7.83	52	0.7692	6.41
20	0.9333	7.78	53	0.7650	6.37
21	0.9271	7.72	54	0.7608	6.34
22	0.9210	7.67	55	0.7567	6.30
23	0.9150	7.62	56	0.7526	6.27
24	0.9090	7.57	57	0.7486	6.24
25	0.9032	7.53	58	0.7446	6.20
26	0.8974	7.48	59	0.7407	6.17
27	0.8917	7.43	60	0.7368	6.14
28	0.8860	7.38	61	0.7329	6.11
29	0.8805	7.34	62	0.7290	6.07
30	0.8750	7.29	63	0.7253	6.04
31	0.8695	7.24	64	0.7216	6.01
32	0.8641	7.20	65	0.7179	5.98
33	0.8588	7.15	66	0.7142	5.95
34	0.8536	7.11	67	0.7106	5.92
35	0.8484	7.07	68	0.7070	5.89
36	0.8433	7.03	69	0.7035	5.86
37	0.8383	6.98	70	0.7000	5.83
38	0.8333	6.94	75	0.6829	5.69
39	0.8284	6.90	80	0.6666	5.55
40	0.8235	6.86	85	0.6511	5.42
41	0.8187	6.82	90	0.6363	5.30
42	0.8139	6.78	95	0.6222	5.18

Specific gravity $\times 10$ = pounds per Imperial gallon.

¹ For more complete table, see VAN NOSTRAND'S "Chemical Annual."

TABLE XI.—TABLE FOR CALCULATING THE SPECIFIC GRAVITY OF OILS AT 15.5°C.

Example: $A = \text{sp. gr. at } 20^{\circ}$ $A \times 1.00319 = \text{sp. gr. at } 15.5^{\circ}\text{C.}$

Temperature, degrees Centigrade	Factor	Temperature, degrees Centigrade	Factor	Temperature, degrees Centigrade	Factor	Temperature, degrees Centigrade	Factor
10	0.99612	14	0.99894	18	1.00177	22	1.00462
11	0.99683	15	0.99965	19	1.00248	23	1.00534
12	0.99782	16	1.00935	20	1.00319	24	1.00605
13	0.99823	17	1.00106	21	1.00391	25	1.00677

WRIGHT, C. H., *Jour. Soc. Chem. Ind.*, 26, 513.

TABLE XII.—REPRESENTATIVE SAMPLES OF LUBRICATING OILS

By ALBERT F. SEEKER,
From "Van Nostrand's Chemical Annual"

Name	Sp. gr., 60 degrees Fahrenheit	Flash test, degrees Fahrenheit	Fire test, degrees Fahrenheit	Cold test, degrees Fahrenheit	Saponifiable matter	Ash	Acidity or alkalinity
Air compressor oil....	0.8857	455	525	25	trace	none	neutral
Air compressor oil....	0.8654	410	460	-2	none	none	neutral
Car oil.....	0.8824	354	400	5	none	none	neutral
Cutting oil.....	0.9036	345	425	31	82.9 %	none	1.16 %
Cylinder oil.....	0.8921	535	600	60	20.0 %	trace	neutral
Cylinder oil.....	0.9020	545	600	31	2.4 %	none	neutral
Cylinder oil.....	0.8993	590	600	..	none	0.06 %	neutral
Cylinder oil.....	0.8992	555	600	..	none	0.08 %	neutral
Engine oil.....	0.9163	430	480	27	1.5 %	trace	neutral
Engine oil.....	0.8845	360	415	5	10.0 %	none	0.05 %
Engine oil.....	0.8970	400	465	3	none	none	neutral
Engine oil.....	0.8810	405	470	14	none	0.02 %	neutral
150 degrees fire test oil	0.7864	140	180	..	none	none	neutral
150 degrees fire test oil	0.8206	266	300	32	none	none	neutral
High-speed engine oil.	0.9152	400	465	5	17.2 %	0.06 %	1.09 %
High-speed engine oil.	0.9149	400	475	3	15.3 %	0.04 %	1.06 %
Ice machine oil.....	0.8941	430	495	-4	none	0.13 %	neutral
Machine oil.....	0.8689	420	480	0	trace	none	neutral
Marine engine oil.....	0.8812	405	440	17	none	trace	neutral
Marine engine oil.....	0.8765	435	500	5	none	0.05 %	neutral
Marine engine oil.....	0.9090	405	464	0	12.0 %	0.15 %	0.75 %
Marine engine oil.....	0.9054	400	470	9	9.0 %	0.11 %	0.50 %
Screw cutting oil.....	0.9002	380	425	15	25.0 %	none	1.02 %
Transformer oil.....	0.8646	365	430	2	none	none	neutral

TABLE XIII.—MAUMENÉ TEST, SHOWING THE RISE IN TEMPERATURE OF
COMMON OILS

From "Stillman's Engineering Chemistry," 4th edition

	Name of observer				
	Maumené	Schaedler	Archbutt	Allen	Stillman
	Degrees Centigrade	Degrees Centigrade	Degrees Centigrade	Degrees Centigrade	Degrees Centigrade
Lard oil.....	40	41	39.5
Tallow oil.....	41-43	39
Neat's foot oil.....	45	50	43	40
Oleo oil.....	37½	38½	37
Elain oil.....	38
Sperm oil.....	51	45-47	48
Whale oil.....	92	91	92
Menhaden oil.....	123-128	126	128
Dog-fish oil.....	80
Cod liver oil.....	102-103	103	113	110
Crude cotton seed oil....	69.5	70	67-69	74
Rape oil.....	58	60
Castor oil.....	47	48	46	65	45
Olive oil.....	42	43	41-45	41-43	42
Rosin oil.....	28	18-22	10
Mineral lubricating oil..	3-4	3
Earth nut.....	67	67	47-60
Sea elephant.....	65
Corn oil.....	85

TABLE XIV.—PHYSICAL FACTORS FOR THE MORE COMMON OILS
Average values

Oils	Specific gravity	Degrees Baumé	Pounds per gallon	Maumené number	Iodine number	Saponification number
Castor.....	0.9640	15.2	8.03	46.5	86.0	181.5
Cocanut.....	0.9115	23.6	7.59	21.0	10.0	257.0
Cod liver.....	0.9245	21.4	7.70	107.5	152.0	185.5
Corn (maize).....	0.9232	21.6	7.69	80.0	121.0	190.5
Cotton seed.....	0.9235	21.6	7.69	66.0	110.5	193.0
Hemp seed.....	0.9267	21.1	7.72	97.0	154.0	192.5
Lard.....	0.9160	22.8	7.63	43.5	72.5	196.5
Linseed.....	0.9345	19.8	7.78	115.0	186.0	192.5
Menhaden.....	0.9300	20.5	7.75	126.0	156.0	191.0
Neat's foot.....	0.9153	23.0	7.62	53.0	69.5	194.5
Olive.....	0.9160	22.8	7.63	43.0	79.0	192.5
Palm.....	0.9340	19.9	7.78	54.0	200.5
Peanut.....	0.9165	22.7	7.63	56.0	94.0	191.5
Rape seed (Calsa).....	0.9150	23.0	7.62	58.5	98.5	173.0
Sesame.....	0.9227	21.7	7.69	65.0	108.5	190.5
Soy bean.....	0.9265	21.1	7.72	60.0	130.0	195.0
Sperm.....	0.8808	29.0	7.34	85.0	85.5	135.0
Sunflower.....	0.9249	21.4	7.70	67.5	127.0	191.0
Tung.....	0.9395	19.0	7.83	157.5	193.5
Whale.....	0.9240	21.5	7.69	88.0	119.0	191.0
Water.....	1.0000	10.0	8.33
Aleohol (95 per cent.)....	0.80854	43.15	6.735

NOTE.—Specific gravity, Baumé, gravity and pounds per gallon determined at 60°F.

INDEX

A

- Adiabatic calorimeters, 41, 169
- Air analysis, 202, 203
- Alcohol, 3, 87
 - denatured, 88
 - fuel value, 88
- Alkalinity of water, 135
 - total, 212
- Ammonia in gas, 94
- Analysis of air, 202, 203
- Analysis of coal, 25-30, 141-148
 - ash, 29, 143, 144
 - calculations, 27, 147
 - fixed carbon, 30, 147
 - general plan, 28
 - laboratory sample, 23, 141
 - methods, 27
 - moisture, 25, 28, 142, 143
 - proximate, 141-148
 - sulphur, 29, 76, 171
 - volatile matter, 30, 146
 - working sample, 23, 141
- Aquadag, 138
- Ash and water, free substance, 31
- Ash in coal, 29, 33, 62, 143
 - corrected ash, 29, 32
 - determination, 143
 - fusibility, 70
 - penalties for excess, 63, 64
 - variations, 16, 18
- Available hydrogen, 49

B

- Boiler waters (see Water), 112-136, 204-220
- British thermal unit, defined, 36

C

- Calculations from air dry to dry coal, etc., 27, 147

- Calculations involving unit coal, 53
 - commercial guarantees, 60
 - in settlement of contracts, 60
- Calorie, defined, 36
- Calorific determinations, 149-170
 - Berthier test, 38
 - correction for acids, 43
 - corrections for fuse wire, 45, 155, 168
 - definitions, 36
 - oxygen bomb method, 39, 161-170
 - peroxide bomb method, 45, 149-160
 - radiation corrections, 40, 154, 155, 167
- Calorific values, 36
 - anthracites, 156
 - calculated by formula, 37, 101
 - carbon, 37
 - coal, 37, 56, 149-170
 - coke, 156
 - computations in connection
 - with oxygen bomb, 167
 - gas, 90-94, 196
 - gross and net heat values, 47, 94
 - wood, 83, 84
- Calorimeters, 38-48
 - adiabatic, 41, 169
 - continuous flow gas, 92, 197
 - gas, 90-93, 197
 - intermittent gas, 91
 - junker, 92, 197
 - Lewis-Thompson, 38
 - Mahler bomb, 39
 - oxygen bomb, 39, 161-170
 - Parr non-continuous gas, 91
 - peroxide bomb, 45, 149-160
 - water equivalent, 155, 167
- Carbon dioxide in water, 211
- Carbon in coal, 49, 107, 179
 - method of determining, 179-183

- Centigrade, conversion to Fahrenheit, 36
- Classification of coals, 51-58
 bibliography, 58
 Campbell's, 52
 carbon ratio, 52
 carbon-hydrogen ratio, 52
 Frazer's, 51
 fuel ratio, 51
 heating value as a basis, 52
 unit coal as a basis, 53-58
- Classification of water, 119
 according to type of mineral constituent, 119
 as used by the C. B. & Q. Ry., 131
 by the association of railway chemists, 116
- Cleveland open cup flash and fire tester, 223
- Clinker formation, 69
 cause, 70
 prevention, 70
- Coagulants, 125
- Coal, 2, 5
 analysis, 25-30
 classification, 51-58
 deterioration, 73
 distribution, 7, 9
 output, 5, 8
 production, annual, 6
 production, by states, 8
 proximate analysis, 141-148
 reserves, 7
 sampling, 11-24
 spontaneous combustion, 73
 storage, 73-79
 weathering, 73
- Coal contracts, 59-64
 bids and awards, 62
 double standard of reference, 62
 formulation of proposals, 64
 penalties for ash, 63, 64
 price and payment, 64
 significance of heating values, 62
 use of unit coal, heating values, 60
- Coke, 2, 80-82
 analysis, 81
 heating value, 156
 metallurgical, 80
 pulverizing, 81
 sampling, 81
 sulphur, 82
 volatile matter, 81
- Combustible, 31
- Combustion of coal, 65-72
 clinker formation, 69
 efficiencies, 107-111
 losses up flue, 109
 other losses, 110
 oxygen supply, 66
 pounds of air per pound of coal, 107
 ratio of entering to air used, 108
 smoke, 67
 wetting of coal, 71
- Compositing of coal samples, 19
- Compounded oils, 138
- Conradson test on oil, 140, 227
- Contracts (see Coal contracts), 59
- Corrosive ingredients in water, 119
- D
- Deterioration of coal, 73
- Distillates, 3, 86
 heating values, 3, 87
 output, 86
- Dry coal, 25
- Dulong's formula, 37, 49
- Dust determination, 23
- E
- Embrittling action of alkaline waters, 135
- Emulsions of oil, 138
- F
- Feldspar, decomposition of, 114
- Fixed carbon, 30, 147
 determination, 147

- Flash and fire test, 139, 223
 Float and sink coal, table of heating values, 34
 Flue gas, 104-111, 201-203
 analysis, 106, 203
 calculation of volumes and weights, 107
 composition, 104, 108
 loss of heat, 109
 ratio of air entering to air used, 108
 sampling, 106
 solutions for analysis, 201
 Foaming ingredients, 117
 Fuel (see Coal).
- G
- Gas, fuel, 3, 89-103
 ammonia, 94
 analysis, 95, 185-200
 apparatus for analysis, 95, 185
 blast furnace gas, 90
 calorimeters, 90-94, 197
 computation of volume of paraffins, 98
 combustion temperatures, 97
 heating value, 90, 196
 heating value by calculation, 101
 high and low heating values, 94, 101, 102
 house gas, 4, 90
 natural gas, 4, 90
 producer gas, 4, 90
 production, 89
 reagents for analysis, 95, 188
 sulphur, 94, 144
 types of gas, 89
 Gas analysis, 95, 185-200
 absorption methods, 95, 188, 201
 combustion methods, 97, 191
 errors, 100, 103, 193
 sulphur, 94, 189, 194
 Gas calorimeter corrections, 92, 94
 humidity, 236, 237
 Gas inlet water temperature, 93
 thermometer stem, 238
 Gasoline, calorific value, 87, 157
 Gross and net heating values, 47, 94, 101
 Gypsum, solubility, 115
- H
- Hardness, 132, 213
 negative, 214
 permanent, 213
 total, 214
 Heating value of coal, 37, 56, 149-170
 Heating value of gas, 90, 101
 Honeycomb and clinker formation, 70
 Hubbard specific gravity bottle, 222
 Hydrogen in coal, 49, 184
 available, 49
 by calculation, 49, 184
 Dulong's formula, 37, 49
 Hydrogen in gas, 97, 191
 Hydrogen sulphide in gas, 94, 189, 194
- I
- Illinois coal, composition, 56
- J
- Junker calorimeter, 92, 197
- L
- Lime, 122, 124
 hydrated, 124
 impurity allowed for, 123
 solubility, 124
 use, 122
 use in water treatment, 122
 Lubricants, 137-140
 analysis, 221-229
 Conradson test, 140, 227
 emulsification, 140, 228

- Lubricants, flash and fire test, 139, 223
 free acid test, 140, 226
 Maumené test, 227
 methods for testing, 221-229
 saponification number, 140, 226
 specific gravity, 139, 221
 viscosity, 139, 224
- M
- Maumené test, 227
 Mineral constituents of water, 112
 analysis, 204-219
 characteristics, 114
 source, 112
 Modified Orsat apparatus, 95-185
 Moisture in coal, 25, 77
 determination, 143
 interpretation of values, 28
 loss on air drying, 142
 loss in sampling, 21
 Motion, source, 1
- N
- Nitrogen in coal, 50
 Nomenclature (referring to coal), 25
 Non-coal, 32
 Normal solutions, 204
- O
- Oildag, 138
 Oils (see Lubricants), 137-140
 animal, 137
 compounded, 138
 vegetable, 137
 Orsat apparatus, 201
 Oxygen bomb calorimeter, 161-170
 adiabatic insulation, 41, 169
 corrections, 43, 167
 manipulation, 163-167
 standardization, 169
 Oxygen in coal, 50, 184
- P
- Permutit, 132
 Peroxide calorimeter, 149-160
 accelerator, 151
 anthracites, 156
 calculations, 155
 charge, 151
 chemicals, 151
 coke, 156
 dismantling, 156
 gasoline, 157
 ignition, 153
 petroleum oils, 157
 readings, 154
 sample, 150
 standardization, 159
 Petroleum, 3, 85
 distillates, 86
 heating value, 3, 85, 157
 output, 85
 Power, 1
 Proximate analysis, 141-148
 Pure coal, 31
 Pycnometer, 221
 Pyrites in coal, 76
- R
- Radiation corrections, 40, 154, 166
 oxygen bomb, 40, 166
 peroxide bomb, 154
 Riffling, 17
- S
- Sampling of coal, 11-24
 amount required, 12
 ash variations, 16, 18
 car lots, 18
 care, 11
 commercial sampling, 11
 composite samples, 19
 coning and quartering, 15
 dust determinations, 23
 face samples, 11
 grinder used, 14

- Sampling, hand samples, 11
 laboratory sample, 23
 material taken, 12
 mechanical sampling, 20
 mixing, 15
 moisture control, 21
 riffing, 17
 sizes, 13
 Saybolt standard universal viscosimeter, 225
 Scaling ingredients, 115
 effect, 116
 Sink and float values for ash, 33
 Smoke, 67
 Smokeless combustion, 66, 69
 Soda ash in water treatment, 124
 Specifications for coal (see Coal contracts).
 Specific gravity of oils, 221
 Spontaneous combustion, 73
 oxidation stages, 73-78
 Standard solutions, 205-206
 calcium chloride, 208
 soap solutions, 208-209
 sodium carbonate, 205
 sulphuric acid, 206
 Stokers, 69
 Storage of coal, 73-79
 deterioration, 73
 iron pyrites, effect, 76
 methods, 78
 moisture, influence, 77
 oxidation and heat stages, 73-78
 spontaneous combustion, 73
 weathering, 73
 Sulphur, 29, 171
 curve for photometer, 176
 in coal, 29, 76, 171
 in coke, 82
 in gas, 94, 189, 194
 photometer, 174-178
 Sulphur determination, 171-178
 Eschka mixture method, 172
 from oxygen bomb, 171
 from peroxide fusion, 172
 photometric, 174
- T
- Tagliabue closed cup flash point tester, 223
 Total carbon in coal, 37, 49, 108
 apparatus for measuring, 179
 determination, 179
 table for weight of carbon, 182
 use of carbon values, 37, 108
 Treatment of boiler water, 120-136
 industrial appliances, 128
 lime as used, 122
 tabulated scheme, 121
- U
- Ultimate analysis of coal, 49-50, 179-184
 hydrogen by calculation, 49, 184
 oxygen by calculation, 184
 Unit coal, 31-35
 accuracy of constants, 33
 calculation of commercial values, 60
 definitions, 31
 derivation of formula, 32
 formula for calculating, 33
 formula for heating values, 53
 heating values, 56, 57
 sink and float values, 33
 use in classification, 53
 use in contracts, 60
- V
- Volatile matter in coal, 30, 146
 official method, 146
 optional method, 146
 Volatile fuels, 3, 86, 87
 heating values by oxygen bomb, 87
 heating values by peroxide bomb, 157
- W
- Water for industrial use, 112-136
 alkalinity, 135, 212
 analysis, 112, 204-219

- Water, artesian, 113
 calcium sulphate, 210
 calculations, 218, 219
 carbon dioxide, 211
 chemical treatment, 120
 classification, 116, 119, 131
 coagulants, 125
 corrosive ingredients, 119
 deep wells, 113
 determination of sulphur, 207
 embrittling action (NaOH), 135
 foaming ingredients, 117
 hardness, 212-214
 impurities, 115
 industrial methods, 128
 lime treatment, 122
 limits of purification, 132
 magnesia, 212
 mineral constituents, 112, 114
 negative hardness, 214
 permanent hardness, 213
- Water, scaling ingredients, 115-116
 shallow wells, 113
 soda ash, treatment, 124
 springs, 113
 standards of hardness, 132
 surface water, 113
 temporary hardness, 212
 total alkalis, 217
 total hardness, 214
 total sulphates, 216
 treated water, examination of,
 218
 typical waters, 132
- Weathering of coal, 73
Wet coal, 25, 142
Wetting of coal, 71
Wood, heating value, 2, 83, 84

Z

Zeolites, 132

